

Valli.

handle creators

2023



Catalogo / Catalogue

Valli.
handle creators

Catalogo 2023
2023 Catalogue



Tutta la storia
dell'architettura
ruota esclusivamente
attorno alle aperture
nei muri.

The whole history of architecture revolves exclusively around the wall openings.

Le Corbusier, 1927

Introduzione / Introduction [p. 10](#)

Finiture / Finishes [p. 32](#)

Maniglie per porta / Door handles

Collezione Fusital / Fusital collection [p. 36](#)

Collezione Lab / Lab collection [p. 140](#)

Coordinati e accessori / Matches and accessories

Maniglie per finestra / Window handles [p. 204](#)

Pomoli / Door knobs [p. 224](#)

Maniglioni / Pull handles [p. 230](#)

Alzanti scorrevoli / Lift and slide handles [p. 238](#)

Bocchette, Placche / Escutcheons, Plates [p. 240](#)

Maniglie per incasso / Inset handles [p. 245](#)

Chiusure privacy BZG / Bathroom privacy sets [p. 252](#)

Fermaporta / Door stops [p. 262](#)

Porta abiti - Ganci / Coat hooks - Hooks [p. 263](#)

Informazioni tecniche / Technical informations [p. 264](#)

Disegni tecnici / Technical drawings [p. 266](#)

Certificazioni / Certifications [p. 293](#)

Collezione Fusital / Fusital collection

H 386 Meneghello Paoletti p. 102	H 385 Federica Biasi p. 70	H 384 CetraRuddy Architecture D.P.C. p. 58	H 383 Perkins&Will p. 108	H 382 Joe Cheng p. 86	H 381 Khalid Al Najjar p. 90
H 380 Antonio Citterio p. 42	H 379 Antonio Citterio p. 44	H 378 Yabu Pushelberg p. 132	H 377 P Steve Leung p. 118	H 377 Steve Leung p. 116	H 376 Giancarlo Vegni p. 78
H 374 Franco Poli p. 74	H 372 Eri Goshen p. 68	H 370 Doriana e Massimiliano Fuksas p. 64	H 368 Cerri & Associati p. 56	H 367 Giancarlo Vegni p. 80	H 364 Mario Bellini p. 92
H 361 Antonio Citterio - Toan Nguyen p. 52	H 359 Skidmore, Owings & Merrill p. 114	H 356 Zaha Hadid p. 138	H 348 David Chipperfield p. 60	H 343 John Pawson p. 88	H 338 Yoshimi Kono p. 134
H 335 Richard Meier p. 112	H 334 Foster + Partners p. 72	H 330 Matteo Thun p. 100	H 329 Taller Design Ricardo Bofill p. 120	H 327 Antonio Citterio p. 46	H 317 Antonio Citterio p. 48
H 315 Pierluigi Cerri p. 110	H 311 Mario Bellini p. 94	H 5017 Hans Kollhoff p. 82	H 5015 Antonio Citterio p. 50	H 5008 Taller Design Ricardo Bofill p. 122	H 1068 Pembroke & Ives p. 106
H 1066 Bertone Design p. 54	H 1061 Di Virgilio Veneziano p. 62	H 1052 Mikhail Leykin p. 104	H 1045 Yoshimi Kono p. 136	H 1044 Vincent Van Duysen p. 124	H 1044 U Vincent Van Duysen p. 126

Collezione Lab / Lab collection

H 1044 Q Vincent Van Duysen p. 128	H 1044 U Q Vincent Van Duysen p. 130	H 1043 Matteo Thun p. 96	H 1040 Gabriele e Oscar Buratti p. 76	H 1039 Jean-Baptiste Sibertin Blanc p. 84	H 1026 Antonio Bullo p. 40
H 1003 Matteo Thun p. 98	H 198 Eero Aarnio p. 66				
H 1067 Rose p. 182	H 1065 Naked Due p. 172	H 1064 Naked p. 170	H 1062 Carmen p. 146	H 1058 Amica p. 142	H 1057 Retrò p. 180
H 1056 T Quadra p. 178	H 1056 Quadra p. 176	H 1054 W.W. p. 190	H 1050 Giasone p. 158	H 1049 T Divara p. 152	H 1049 Divara p. 150
H 1046 T Nais p. 168	H 1046 Nais p. 166	H 1037 Teseo p. 188	H 1027 Dafne p. 148	H 1024 Lolita p. 160	H 1022 Ernani p. 154
H 1016 Nabucco p. 164	H 1004 Antares p. 144	H 192 Prunus p. 174	H 176 Spiga p. 186	H 165 Germana p. 156	H 163 Sarissa p. 184
H 123 Luigi XVI p. 162	H 419 Bordeaux p. 194	H 416 Garnet p. 196	H 414 Amber p. 192	H 411 Leila p. 198	H 411 Q Leila p. 200

Collezione Fusital / Fusital collection

H 1026	Antonio Bullo	p. 40	○	H 374	Franco Poli	p. 74	○	H 383	Perkins&Will	p. 108	○
H 380	Antonio Citterio	p. 42	○	H 1040	Gabriele e Oscar Buratti	p. 76	□	H 315	Pierluigi Cerri	p. 110	○
H 379	Antonio Citterio	p. 44	○	H 376	Giancarlo Vegni	p. 78	□	H 335	Richard Meier	p. 112	○
H 327	Antonio Citterio	p. 46	○	H 367	Giancarlo Vegni	p. 80	□	H 359	Skidmore, Owings & Merrill	p. 114	○
H 317	Antonio Citterio	p. 48	○	H 5017	Hans Kollhoff	p. 82	○	H 377	Steve Leung	p. 116	□
H 5015	Antonio Citterio	p. 50	○	H 1039	Jean-Baptiste Sibertin Blanc	p. 84	○	H 377 P	Steve Leung	p. 118	□
H 361	Antonio Citterio - Toan Nguyen	p. 52	□	H 382	Joe Cheng	p. 86	○	H 329	Taller Design Ricardo Bofill	p. 120	○
H 1066	Bertone Design	p. 54	□	H 343	John Pawson	p. 88	○	H 5008	Taller Design Ricardo Bofill	p. 122	○
H 368	Cerri & Associati	p. 56	○	H 381	Khalid Al Najjar	p. 90	○	H 1044	Vincent Van Duysen	p. 124	○
H 384	CetraRuddy Architecture D.P.C.	p. 58	○	H 364	Mario Bellini	p. 92	□	H 1044 U	Vincent Van Duysen	p. 126	○
H 348	David Chipperfield	p. 60	○	H 311	Mario Bellini	p. 94	□	H 1044 Q	Vincent Van Duysen	p. 128	□
H 1061	Di Virgilio Veneziano	p. 62	○	H 1043	Matteo Thun	p. 96	○	H 1044 U Q	Vincent Van Duysen	p. 130	□
H 370	Doriana e Massimiliano Fuksas	p. 64	□	H 1003	Matteo Thun	p. 98	○	H 378	Yabu Pushelberg	p. 132	○
H 198	Eero Aarnio	p. 66	○	H 330	Matteo Thun	p. 100	○	H 338	Yoshimi Kono	p. 134	○
H 372	Eri Goshen	p. 68	□	NEW H 386	Meneghello Paoletti	p. 102	○	H 1045	Yoshimi Kono	p. 136	□
NEW H 385	Federica Biasi	p. 70	○	H 1052	Mikhail Leykin	p. 104	○	H 356	Zaha Hadid	p. 138	□
H 334	Foster + Partners	p. 72	○	H 1068	Pembroke & Ives	p. 106	□				

Collezione Fusital / Fusital collection

H 386	p. 102	H 376	p. 78	H 343	p. 88	H 5015	p. 50	H 1043	p. 96
H 385	p. 70	H 374	p. 74	H 338	p. 134	H 5008	p. 122	H 1040	p. 76
H 384	p. 58	H 372	p. 68	H 335	p. 112	H 1068	p. 106	H 1039	p. 84
H 383	p. 108	H 370	p. 64	H 334	p. 72	H 1066	p. 54	H 1026	p. 40
H 382	p. 86	H 368	p. 56	H 330	p. 100	H 1061	p. 62	H 1003	p. 98
H 381	p. 90	H 367	p. 80	H 329	p. 120	H 1052	p. 104	H 198	p. 66
H 380	p. 42	H 364	p. 92	H 327	p. 46	H 1045	p. 136		
H 379	p. 44	H 361	p. 52	H 317	p. 48	H 1044	p. 124		
H 378	p. 132	H 359	p. 114	H 315	p. 110	H 1044 U	p. 126		
H 377 P	p. 118	H 356	p. 138	H 311	p. 94	H 1044 Q	p. 128		
H 377	p. 116	H 348	p. 60	H 5017	p. 82	H 1044 U Q	p. 130		

Collezione Lab / Lab collection

H 414	Amber	p. 192	○	H 165	Germana	p. 156	⊕	H 1064	Naked	p. 170	○
H 1058	Amica	p. 142	○	H 1050	Giasone	p. 158	○	H 192	Prunus	p. 174	○
H 1004	Antares	p. 144	⊕	H 411	Leila	p. 198	○	H 1056	Quadra	p. 178	□
H 419	Bordeaux	p. 194	□	H 411 Q	Leila	p. 200	□	H 1056 T	Quadra	p. 176	○
H 1062	Carmen	p. 146	○	H 1024	Lolita	p. 160	○	H 1057	Retrò	p. 180	○
H 1027	Dafne	p. 148	○	H 123	Luigi XVI	p. 162	⊕	H 1067	Rose	p. 182	○
H 1049	Divara	p. 150	□	H 1016	Nabucco	p. 164	○	H 163	Sarissa	p. 184	○
H 1049 T	Divara	p. 152	○	H 1046 T	Nais	p. 168	○	H 176	Spiga	p. 186	⊕
H 1022	Ernani	p. 154	○	H 1046	Nais	p. 166	□	H 1037	Teseo	p. 188	⊕
H 416	Garnet	p. 196	○	H 1065	Naked due	p. 172	○	H 1054	W.W.	p. 190	○

Coordinati e accessori / Matches and accessories

Maniglie finestra / Window handles	p. 204	Maniglie per incasso / Inset handles	p. 245
Pomoli / Door knobs	p. 224	Chiusure privacy BZG / Bathroom privacy sets	p. 252
Maniglioni / Pull handles	p. 230	Fermaporta / Door stops	p. 262
Alzanti scorrevoli / Lift and slide handles	p. 238	Porta abiti - Ganci / Coat hooks - Hooks	p. 263
Bocchette / Escutcheons	p. 240		

Collezione Lab / Lab collection

H 1067	p. 182	H 1049	p. 150	H 165	p. 156
H 1065	p. 172	H 1046 T	p. 168	H 163	p. 184
H 1064	p. 170	H 1046	p. 166	H 123	p. 162
H 1062	p. 146	H 1037	p. 188	H 419	p. 194
H 1058	p. 142	H 1027	p. 148	H 416	p. 196
H 1057	p. 180	H 1024	p. 160	H 414	p. 192
H 1056 T	p. 178	H 1022	p. 154	H 411	p. 198
H 1056	p. 176	H 1016	p. 164	H 411 Q	p. 200
H 1054	p. 190	H 1004	p. 144		
H 1050	p. 158	H 192	p. 174		
H 1049 T	p. 152	H 176	p. 186		

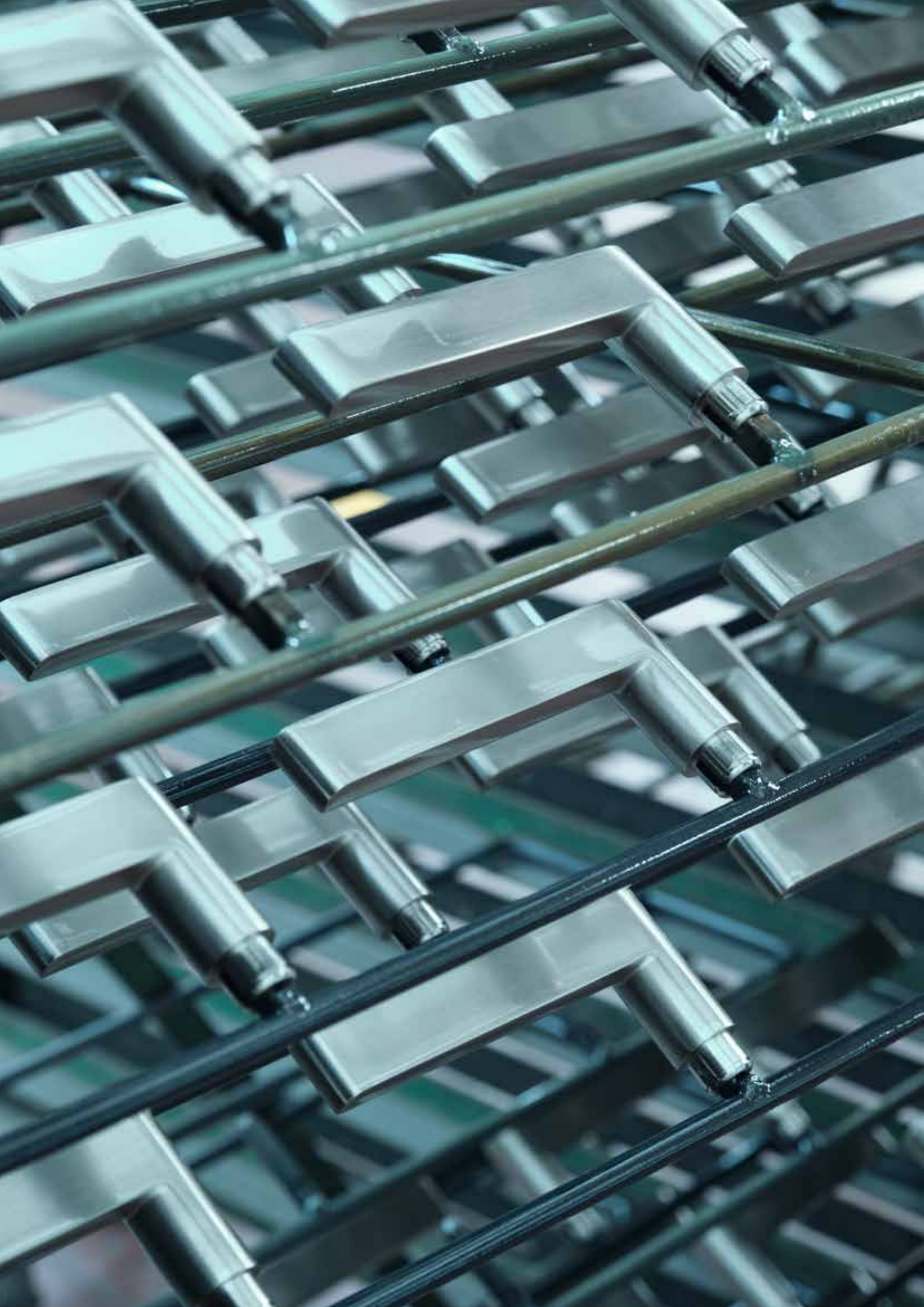

Valli è un'azienda italiana che crea maniglie e accessori dal 1934.

Valli is an Italian company that has created handles and accessories since 1934.

Fondata da Pasquale Valli a Renate, in Brianza, Valli si è sviluppata intorno all'intuizione originaria del suo fondatore, secondo il quale una maniglia non è un semplice utensile di ferramenta ma una scultura dotata di una propria personalità, come una piccola opera d'arte domestica. La tendenza a concepire gli oggetti e i dettagli dal punto di vista della forma appartiene da sempre al modello creativo e artigianale italiano, che vede nell'innovazione una linea evolutiva della tradizione e nell'estetica una componente essenziale della funzione. È Carlo Edoardo Valli a perfezionare e portare a compimento l'intuizione del padre, inventando il concetto di "maniglia d'autore" e inaugurando, con grande anticipo sui tempi e sulle mode, una rivoluzionaria collaborazione con alcuni dei designer e degli architetti più conosciuti. Inizia così, con la linea Fusital, la produzione delle prime maniglie firmate.

L'approccio autoriale, insieme alla sperimentazione di forme e materiali sempre nuovi in tutti i processi di produzione, proiettano Valli nella dimensione del design industriale, trasformando l'azienda in un marchio apprezzato e riconosciuto in tutto il mondo.

Nel 2008 Valli entra a far parte del gruppo ASSA ABLOY accentuando la sua vocazione di brand internazionale con cuore, radici e anima italiani.

Founded by Pasquale Valli in Renate, Brianza, the Valli company grew around the ideas of its founder, who believed that a handle was not merely a simple piece of hardware but a sculpture with its own personality, similar to a small, domestic work of art.

A tendency to imagine objects and details from the perspective of shape has always been inherent to the Italian creative and artisanal model, which sees innovation as an evolutionary line of tradition and aesthetics as an essential component of function. It was Carlo Edoardo Valli who developed and refined his father's idea, inventing the concept of the design handle and launching, well ahead of the times and trends, a revolutionary collaboration with some of the best-known designers and architects of the time.

And that is how production of the first design handle began: with the Fusital line.

This creative approach, paired with constant experimentation with new shapes and materials throughout the production process, took Valli into the industrial design sector, developing the company into the globally recognised brand that it is today.

In 2008, Valli joined the ASSA ABLOY group, emphasising its identity as an international brand with an Italian heart, roots, and soul.

I valori di un'azienda come Valli non sono mai astratti ma, al contrario, si trovano incorporati all'interno dei suoi prodotti: ogni singolo esemplare di maniglia è il condensato di quella visione, perché quelli di Valli sono valori duraturi e si trasmettono integri e solidi nel tempo.

La cultura del progetto è il valore attraverso cui si produce il design: qui agiscono passioni, saggezza, consapevolezza, innovazione, dialogo, esattezza, efficacia e senso del bello. È la cooperazione di tutti questi fattori che permette di imprimere agli oggetti-maniglia quella sintesi di armonia e precisione, di forma e di funzione, che definiscono l'essenza più pura del disegno industriale italiano.

La stratigrafia e l'accumulo delle conoscenze sono valori integrati all'interno di tutti i processi produttivi. Alcune competenze derivano dalla sensibilità artigianale dei gesti che si ripetono e si perfezionano nel tempo, altre provengono dalla sperimentazione e dall'adozione di tecniche e strumentazioni innovative: insieme diventano essenziali per definire lo stile di Valli.

La versatilità è infine il risultato dell'intensa dialettica con i designer e gli architetti di tutto il mondo, che ha permesso di costruire un bagaglio di competenze unico, ricco e irripetibile. Grazie alla sua versatilità Valli è in grado di proporre un'estesa gamma di maniglie e finiture molto diverse fra di loro, di modificarle e migliorarle sartorialmente e di farle funzionare ovunque, adattandole a tutti i principali standard internazionali.

The Valli principles are fully incorporated into its products: every single handle embodies the company vision because Valli is founded on solid, enduring values.

Valli project culture brings passion, wisdom, awareness, innovation, dialogue, accuracy, effectiveness, and a sense of beauty into play when designing. It is the combination of all these factors that allows harmony and precision as well as form and function to coexist within these handles, all qualities that represent the essence of Italian industrial design.

The expertise that Valli has gained over time is integrated into all production processes. Some skills derive from the precision of manual actions that are repeated and perfected over time, others come from experimentation and the adoption of innovative techniques and tools: together they are essential to the Valli style.

Finally, versatility is the result of intense dialogue with designers and architects from all over the world, which has allowed the brand to build a rich and unique skillset. Thanks to this versatility, Valli can offer an extensive range of very different handles and finishes, modify and improve them upon request, and fit them anywhere by adapting to all the main international standards.

La cultura del progetto, la cura artigianale e la versatilità formano il prisma dei valori Valli.

Project culture, craftsmanship, and versatility represent Valli's core values.





Milano, Brianza, Italia. La tradizione e le radici del design d'autore.

Milan, Brianza, Italy. The tradition and roots of artisanal design.

La produzione di Valli, il cuore pulsante dell'azienda, si trova da sempre a Renate, Brianza, Italia.

Qui Pasquale Valli ha inaugurato il suo laboratorio ed è ancora qui che fra gli anni Cinquanta e Sessanta l'azienda ha acquisito una scala internazionale, costruendo gli stabilimenti e le strutture direzionali che ancora oggi ospitano la produzione e la direzione. Se Milano è la capitale del design italiano, la Brianza è la sua officina produttiva. È in questo perimetro geografico di eccezionale densità creativa che le forme, le idee, le invenzioni e le ricerche si traducono in oggetti concreti, diventando espressioni del Made in Italy.

Le radici del design italiano affondano in un contesto irripetibile, nato dall'evoluzione di una sapienza e di una capacità manuale secolari e di altissima qualità esecutiva, trasferite poi, con esiti eccellenti, nella cultura del progetto industriale, la stessa con cui Valli crea i suoi prodotti raccolti nelle due collezioni Fusital e Lab.

Valli production, the beating heart of the company, is located in Renate, Brianza, Italy.

This is where Pasquale Valli opened his workshop and where the company grew to an international scale between the 1950s and 1960s, building the structures that still house production and management to this day. If Milan is the capital of Italian design, Brianza is its workshop. It is in this geographical perimeter of exceptional creativity that shapes, ideas, inventions, and research are translated into concrete objects representing the Made in Italy brand.

The roots of Italian design stem from a truly unique context: born of the evolution of centuries-old wisdom, manual expertise, and extremely high manufacturing quality, and transferred into industrial design culture with excellent results. It is this same culture that Valli relies on when making its products, released under two different collections: Fusital and Lab.



Fusital è l'élite collection di Valli, ambasciatrice dello stile e della forma.

Fusital: Valli's élite collection, ambassador for style and form.

Nata nel 1976 quando Carlo Edoardo Valli decide di fondare un nuovo marchio, Fusital sancisce l'apertura dell'azienda all'universo del design e della creatività coinvolgendo da subito i designer e gli architetti più prestigiosi del panorama internazionale per realizzare l'idea di maniglia d'autore. Gae Aulenti e Achille Castiglioni, Norman Foster, Renzo Piano e Antonio Citterio, oppure Bob Noorda, al quale nel 1984 viene commissionato il nuovo logo e la corporate identity, sono solo alcuni dei nomi più noti tra coloro che hanno collaborato alla costruzione del mito di Fusital.

Oggi come allora Fusital resta la élite collection di Valli e raggruppa tutte le più prestigiose maniglie del brand, quelle in cui sono manifesti l'audacia dello stile e la cura dell'estetica. Le maniglie della collezione Fusital portano la firma di alcune delle maggiori personalità del design e dell'architettura contemporanea.

Founded in 1976, when Carlo Edoardo Valli decided to launch a new brand, Fusital marked the company's entrance into the universe of design and creativity, immediately involving the most prestigious designers and architects on the international scene. Gae Aulenti, Achille Castiglioni, Norman Foster, Renzo Piano, Antonio Citterio and Bob Noorda - who was commissioned to design the new logo and corporate identity in 1984 - are just some of the globally recognised names that have contributed to building the Fusital legend.

Today as yesterday, Fusital is Valli's high-end collection and comprises the brand's most prestigious handles, all defined by a bold style and strong aesthetic focus. The Fusital collection boasts handles designed by some of the leading personalities in contemporary design and architecture.

Lab è la collezione di maniglie concepita e disegnata totalmente in house all'interno degli atelier e dei laboratori di ricerca e sviluppo Valli. Il suo nome evoca la dimensione operativa del brand, proiettata verso il futuro, il costante perfezionamento ergonomico, l'evoluzione delle tecniche di lavoro, la sperimentazione di nuovi approcci e di nuovi materiali.

Le maniglie della collezione Lab si distinguono per l'attenzione minuziosa al dettaglio, per l'impeccabile efficacia delle meccaniche e per la straordinaria qualità esecutiva, esito di un perpetuo lavoro di aggiornamento metodologico, aderendo in maniera rigorosa ai principi di essenzialità della forma-funzione che identificano la cultura italiana del progetto industriale.

The Lab collection is entirely conceived and designed in-house at Valli. Its name evokes the brand's forward-looking operational model, constant ergonomic improvement, evolving techniques, and experimentation with new approaches and materials.

Handles from the Lab collection stand out for their extreme attention to detail, impeccable mechanics, and extraordinary executive quality. This is the result of constant improvement to the manufacturing process while never straying from the principles of form and function that define Italian industrial design culture.

Lab evoca la dimensione sperimentale del brand per tendenze, forme e materiali.

Lab embodies the brand's experimental approach to trends, shapes, and materials.





Un universo di maniglie multiforme, colorato, versatile e universale.

A universe of multiform, colourful, versatile and universal handles.

Aprire e chiudere una porta o una finestra sono due gesti istintivi che ogni giorno siamo abituati a compiere per decine di volte, sempre impugnando una maniglia. Nell'arco della sua quasi centenaria attività produttiva Valli ha approfondito e studiato i meccanismi del rapporto mano-oggetto con la ricerca dei suoi laboratori e atelier. L'esperienza accumulata nella sua storia d'impresa, l'uso di tecnologie all'avanguardia in tutte le fasi di produzione, il dialogo e l'interscambio continuo con le intuizioni di designer e architetti eminenti sono tutti elementi che hanno permesso a Valli non solo di presentare nel tempo alcuni dei prodotti più iconici e straordinari nel design della maniglia, ma anche di individuare soluzioni estremamente efficaci in termini di ergonomia, di affidabilità e di versatilità. Le maniglie e i complementi Valli, progettati con le tecniche più innovative e i materiali migliori, sono concepiti per durare nel tempo grazie a lavorazioni di grande efficacia meccanica ed estetica. Le competenze tecniche di cui il brand è portatore si manifestano in un'ampia gamma di stili, di valori formali, di colori e di combinazioni che possono interagire con qualsiasi stile e connotazione estetica degli spazi interni: un sistema creativo in costante evoluzione, in grado non solo di attraversare i cambiamenti del gusto e delle mode, ma anche di anticiparli grazie a un dialogo sempre fecondo con progettisti.

La visione globale del brand e un'attenzione ai mercati internazionali sono infine il segreto dell'universalità delle maniglie e dei prodotti Valli, realizzate per funzionare ed essere compatibili con tutti i principali standard internazionali.

Opening and closing a door or a window are instinctive actions that we perform dozens of times every day. And we use a handle every single time.

Over almost a century of activity, Valli has closely studied the relationship between hand and handle.

The brand's history and experience, the use of cutting-edge technologies at all phases of production, and continuous dialogue with distinguished designers and architects have allowed Valli not only to create some of the most iconic and extraordinary products in the handle design sector but also to identify extremely effective solutions in terms of ergonomics, reliability, and versatility. Valli handles and accessories, made with the most innovative techniques and the best materials, are designed to last thanks to highly effective mechanical and aesthetic techniques. The brand's technical expertise can be seen in a wide range of styles, shapes, colours, and combinations, with something to suit any interior style and aesthetic: a creative system in constant evolution, not only outliving changing tastes and trends but anticipating them thanks to a constant dialogue with designers.

Furthermore, the brand's global vision and attentive monitoring of international markets are the secrets to the universal nature of Valli handles, created to function and be compatible with all main international standards.





Le finiture e le lavorazioni assicurano la durata e l'estetica della maniglia.

Finishes and treatments ensure handle durability and aesthetics.

Quello di Valli è uno spettro di finiture ampio e completo, caratterizzato da una ricca, brillante e contemporanea varietà cromatica, in grado di confrontarsi con ogni tipo di progetto di interni. Le finiture svolgono una doppia funzione: da un lato proteggono la maniglia dal deterioramento d'uso, dall'altro sono un elemento decisivo nel definire lo stile e l'aspetto finale del prodotto. Nelle lavorazioni galvaniche, sia lucide che satinato, lo spessore del trattamento conferisce eccellenti prestazioni di resistenza agli agenti atmosferici e all'usura funzionale, prolungando il ciclo di vita della maniglia.

Valli offers a broad spectrum of finishes, characterised by an extensive colour palette, to suit any interior design style. Finishes perform a dual function as they protect the handle from wear and tear while impacting the final appearance of the product. In the case of galvanic processes, both glossy and satin, the thickness of the treatment ensures excellent resistance to atmospheric agents and functional wear, extending the handle's lifecycle.

Le finiture verniciate si riconoscono per la loro atossicità, la contemporaneità estetica data da una perfetta e omogenea stesura del colore sulla maniglia, oltre che per una sensazione naturale al tatto. Le maniglie con finitura PVD (Physical Vapor Deposition) propongono l'applicazione di un sottilissimo rivestimento di composti nano-metallici di elevata durezza, tale da conferire un grado di protezione sino a tre volte maggiore rispetto a una finitura tradizionale.

Painted finishes are atoxic and recognized for the aesthetic contemporaneity given by a perfect and homogeneous application of the color on the lever, they guarantee a natural sensation to the touch. Handles with a PVD finish (Physical Vapor Deposition) are coated with a very thin layer of extremely hard nano-metallic compounds, which provides up to three times the protection of a traditional finish.

L'expertise artigianale di Valli permette di creare pezzi unici e personali.

Valli's artisanal expertise enables the creation of unique and personal pieces.



Maniglia a catalogo / Handle on catalogue
H 377 Steve Leung
Bronzo scuro
 Dark bronze



Maniglia a catalogo / Handle on catalogue
H 377 P Steve Leung
Bronzo scuro + Pelle marrone
 Dark bronze + Brown leather



Personalizzata / Custom handle
H 377 con rosetta tonda
 H 377 with round rose



Personalizzata / Custom handle
H 377 P con pelle martellata
 H 377 P with hammered handle grip



Personalizzata / Custom handle
H 377 con impugnatura in marmo
 H 377 with marble insert



Personalizzata / Custom handle
H 377 con impugnatura godronata
 H 377 with knurled handle grip

Tra le specialità più peculiari del mondo Valli spicca l'alta capacità di customizzazione dei propri prodotti. All'interno di una filiera di produzione industriale che si avvale di strumentazioni e tecnologie avanzate, l'azienda mantiene ancora un'aliquota assai rilevante di expertise artigianale: è grazie a questa sensibilità, che deriva da una conoscenza profonda e personale dell'ecosistema-maniglia, che per Valli è possibile modellare, combinare e variare la silhouette di un prodotto di serie, dialogando con gli architetti e i clienti per trasferire nella realtà le loro intuizioni e necessità.

Ciò si traduce nella creazione di pezzi unici limited edition, prodotti di concezione sartoriale che utilizzano finiture, lavorazioni, elementi o abbinamenti inediti e fuori standard, maniglie di assoluta esclusività.

The countless options for product customisation are a distinguishing feature of the Valli brand. In an industrial production chain that uses advanced equipment and technologies, the company proudly relies on a significant portion of artisan expertise. The result of a comprehensive knowledge of the handle ecosystem, this sensitivity allows Valli to model, combine, and vary the silhouettes of industrial objects, while in constant dialogue with architects and customers to ensure their ideas and needs become reality.

This in turn leads to the creation of unique, limited-edition pieces with new and non-standard finishes, treatments, elements, or combinations, resulting in exclusive, tailor-made handles.



Possibilità di personalizzazione / Personalisation possibilities

Rosetta / Rosette

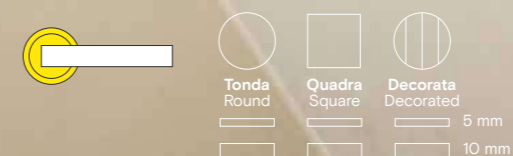

Finitura / Finish

Oltre 25 finiture con possibilità di trattamento PVD e antibatterico. Over 25 finishes with PVD and antibacterial treatment options.

Materiali speciali / Special materials

Possibilità di aggiunta, ove possibile, di inserti in materiali speciali sull'impugnatura (marmo, pelle, sughero, ecc). Additional optional inserts in special materials (such as marble, leather, cork, etc.) where possible.

Texture e forme / Texture and shapes

Lavorazione ove possibile dell'impugnatura. Handle processing, where possible.

Tutte le personalizzazioni tailor made ricadono fuori listino e prevedono pertanto una valutazione di fattibilità, minimi quantitativi d'ordine e un sovrapprezzo di customizzazione. Customisation requests are not included in the price list. Custom orders require a feasibility assessment, a minimum order, and a customisation surcharge.

L'intero flusso di lavoro di Valli, dal concept al packaging, è concepito nel segno della responsabilità e del rispetto per le persone e l'ambiente.

La responsabilità verso il futuro, il pianeta e le nuove generazioni, è oggi una categoria morale con cui ogni realtà produttiva ha il dovere di confrontarsi. Le scelte di oggi condizionano il mondo di domani. La cura, la precisione, il rigore sono codici iscritti da sempre nel catalogo operativo di Valli.

A ciò si aggiungono la massima attenzione all'efficienza dei processi produttivi e la eccezionale durata dei suoi prodotti, che contribuiscono nel tempo a ridurre drasticamente l'uso di risorse e di energie. Valli si impegna da tempo a utilizzare materiali riciclabili, ove possibile, a implementare i sistemi di risparmio energetico e idrico e recuperare e riutilizzare gli scarti di produzione.

Valli's entire workflow, from concept to packaging, is built on respect and responsibility towards people and the environment.

Today, all manufacturing enterprises have a moral duty to take responsibility for the future, the planet, and the generations to come. The choices we make in the present will impact the world of tomorrow. Care, precision, and dedication are the foundations of the Valli brand.

These are complemented by utmost attention to the efficiency of production processes and the exceptional durability of Valli products, which help to drastically reduce the use of resources and energy over time. Valli has long been committed, where possible, to using recyclable materials, implementing energy and water-saving systems, and recovering and reusing production waste.

La responsabilità è un principio abbracciato da Valli in tutte le fasi della produzione.

Responsibility is crucial at all Valli's production stages.



Finiture e trattamenti / Finishes and treatments



Acciaio inox lucido
Polished stainless steel
N1



Acciaio inox satinato
Satin stainless steel
N2

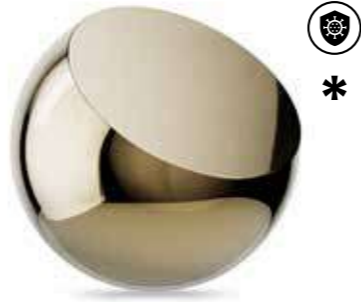

Orolucido
Polished brass
A



Nikmatt
Nikmatt
DA



Nikelnero
Black nickel
DC



Bronzsat
Bronzsat
E



Orsatin
Satin brass
AB



Orsatop
Matt brass
AC



Ottone naturale
Natural brass
B



Bronzop
Matt bronze
EA



Bronzo scuro
Dark bronze
ED



Neropaco
Matt black
F



Ottone antico
Antique brass
BA



Brunito
Burnished
BC



Anticato
Antique
BD



Biancopaco
Matt white
FB



Titanium PVD
H



Light black
Light black
L



Cromo
Polished chrome
C



Cromosat
Satin chrome
CA

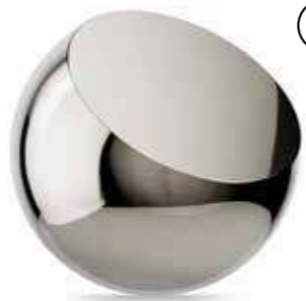

Nickel
Nickel
D



Rame lucido
Polished pure copper
R1



Rame satinato
Satin pure copper
R2

- Le maniglie Valli possono essere personalizzate scegliendo una finitura non standard tra quelle sopra indicate. Condizioni: **quantitativo minimo ordinabile: 24 set; tempi di consegna: minimo 8 settimane, da concordare; sovrapprezzo: da concordare con l'ufficio commerciale.**
- In caso di progetti, è possibile personalizzare le maniglie Valli con finiture speciali, previa visione del campione e/o del riferimento del colore specifico.

- Valli handles can be personalised choosing a non standard finish from those available in this page. Conditions: **minimum quantity for orders: 24 set; delivery times: minimum 8 weeks, to be agreed; surcharge: to be agreed with the Business Management.**
- Valli handles can be personalised for projects with special finishes, after seeing the sample and/or the specific colour code.

BioCote® è una tecnologia approvata da HACCP International e certificata secondo le norme internazionali ISO 9001 e ISO 14001: il trattamento è permanente e consente di abbattere in maniera drastica il rischio di contaminazione incrociata, riducendo fino al 99,5% il numero di batteri presenti sulla maniglia e fino al 99,9% la proliferazione di microbi.

Le finiture PVD possono presentare leggere differenze di tonalità rispetto alle corrispondenti finiture tradizionali.

BioCote® is an HACCP International approved technology, certified by international standards ISO 9001 and ISO 14001. It is a permanent treatment that drastically reduces the risk of cross-contamination, reducing bacteria on the handle by up to 99.5% and the proliferation of microbes by up to 99.9%.

PVD finishes can have slight tone differences compared to the corresponding traditional finishes.



Trattamento antibatterico
Anti-microbial finish



Disponibile anche con finitura PVD
Available also in PVD finish

Matrici finiture

Finishes matrix

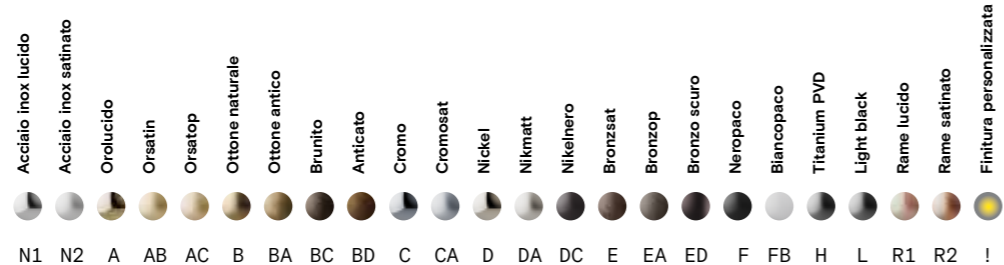

	N1	N2	A	AB	AC	B	BA	BC	BD	C	CA	D	DA	DC	E	EA	ED	F	FB	H	L	R1	R2	!	
H 386 Meneghello Paoelli										•	•													•	
H 385 Federica Biasi										•	•								•						
H 384 CetraRuddy Architecture D.P.C.											•							•	•						
H 383 Perkins&Will											•														
H 382 Joe Cheng															•										
H 381 Khalid Al Najjar						•					•														•
H 380 Antonio Citterio										•	•														
H 379 Antonio Citterio											•				•										
H 378 Yabu Pushelberg											•														•
H 377 P Steve Leung																									
H 377 Steve Leung																									
H 376 Giancarlo Vegni											•														
H 374 Franco Poli											•														
H 372 Eri Goshen											•														
H 370 Doriana e Massimiliano Fuksas											•														
H 368 Cerri & Associati											•														
H 367 Giancarlo Vegni											•														
H 364 Mario Bellini											•														
H 361 Antonio Citterio - Toan Nguyen											•														•
H 359 Skidmore, Owings & Merrill											•														
H 356 Zaha Hadid											•														
H 348 David Chipperfield											•														
H 343 John Pawson											•														
H 338 Yoshimi Kono																									
H 335 Richard Meier											•														
H 334 Foster + Partners																									•
H 330 Matteo Thun																									
H 329 Taller Design Ricardo Bofill											•														
H 327 Antonio Citterio																									
H 317 Antonio Citterio																									
H 315 Pierluigi Cerri																									
H 311 Mario Bellini																									
H 5017 Hans Kollhoff																									
H 5015 Antonio Citterio																									
H 5008 Taller Design Ricardo Bofill																									
H 1068 Pembroke & Ives																									
H 1067 Rose																									
H 1066 Bertone Design																									
H 1065 Naked Due																									
H 1064 Naked																									

Disponibile con finitura PVD

Trattamento antibatterico

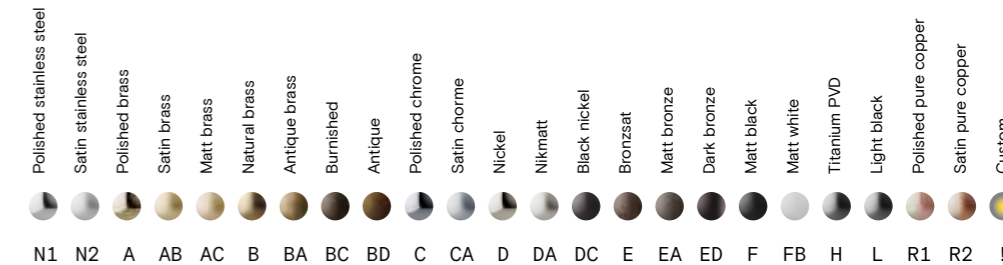

	N1	N2	A	AB	AC	B	BA	BC	BD	C	CA	D	DA	DC	E	EA	ED	F	FB	H	L	R1	R2	!	
H 1062 Carmen																									
H 1061 Di Virgilio Veneziano																									
H 1058 Amica																									
H 1057 Retrò																									
H 1056 T Quadra																									
H 1056 Quadra																									
H 1054 W.W.																									
H 1052 Mikhail Leykin																									
H 1050 Giasone																									
H 1049 T Divara																									
H 1049 Divara																									
H 1046 T Nais																									
H 1046 Nais																									
H 1045 Yoshimi Kono																									
H 1044 Vincent Van Duysen																									
H 1044 U Vincent Van Duysen																									
H 1044 Q Vincent Van Duysen																									
H 1044 U Q Vincent Van Duysen																									
H 1043 Matteo Thun																									
H 1040 Gabriele e Oscar Buratti																									
H 1039 Jean-Baptiste Sibertin Blanc																									
H 1037 Teseo																									
H 1027 Dafne																									
H 1026 Antonio Bullo																									
H 1024 Lolita																									
H 1022 Ernani																									
H 1016 Nabucco																									
H 1004 Antares																									
H 1003 Matteo Thun																									
H 198 Eero Aarnio																									
H 192 Prunus																									
H 176 Spiga																									
H 165 Germana																									
H 163 Sarissa																									
H 123 Luigi XVI																									
H 419 Bordeaux																									
H 416 Garnet																									
H 414 Amber																									
H 411 Leila																									
H 411 Q Leila																									

Available in PVD finish

Anti-microbial finish

Collezione / Collection

Fusital



La storia di Valli è quella di un lungo colloquio con alcune delle personalità più luminose del mondo del design e dell'architettura, un'antologia polifonica che ogni anno e a ogni collezione aggiunge un capitolo nuovo.

The story of Valli is a long conversation with some of the brightest stars from the world of design and architecture, a polyphonic anthology that adds a new chapter to each collection every year.

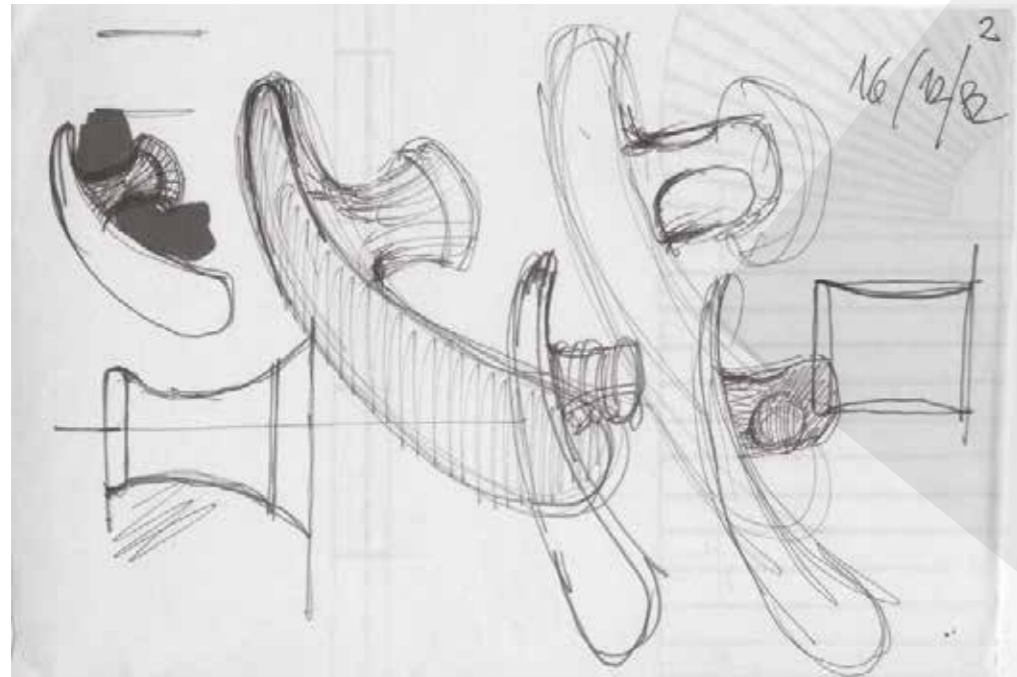

Eero Aarnio, Khalid Al Najjar, Mario Bellini, Taller Design, Ricardo Bofill, Pierluigi Cerri, CetraRuddy Architecture D.P.C., Joe Cheng, David Chipperfield, Antonio Citterio, Foster + Partners, Doriana e Massimiliano Fuksas, Eri Goshen, Zaha Hadid, Hans Kollhoff, Yoshimi Kono, Steve Leung, Richard Meier, John Pawson, Perkins&Will, Franco Poli, Yabu Pushelberg, Skidmore, Owings & Merrill, Matteo Thun, Giancarlo Vegni, Vincent Van Duysen

H 1026 Antonio Bullo si presenta con un design minimale ed essenziale, che combina le forme morbide dell'impugnatura cilindrica insieme al taglio secco e lineare della lama di congiunzione della leva con il perno, definendo un insieme elegante, solido e armonioso.
 H 1026 Antonio Bullo has a minimal design that combines a soft cylindrical grip with the dry, linear shape of the blade connecting the lever to the pin, creating an elegant, solid, and harmonious whole.

Materiale / Material
Ottone / Brass

Maniglia porta / Door handle

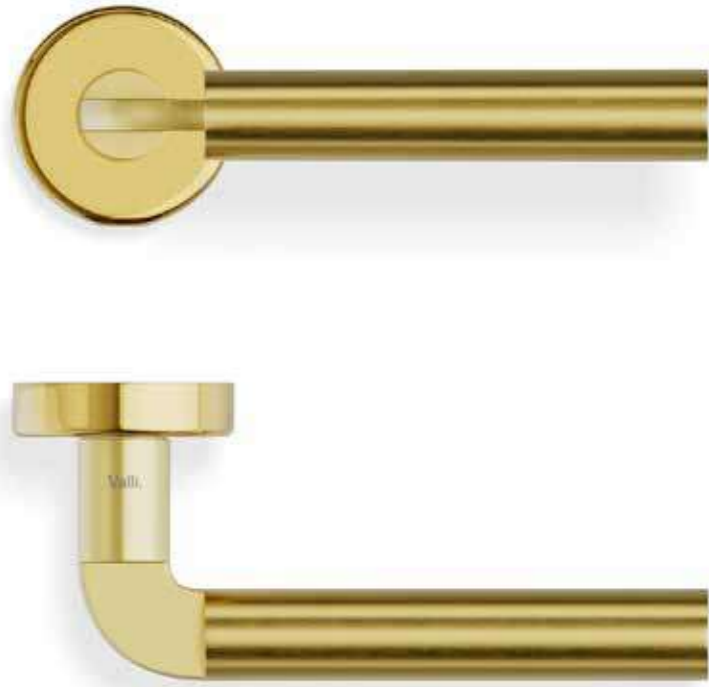

Coordinati / Matches

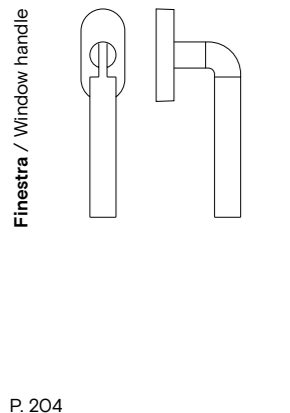

P. 204

In abbinamento sono disponibili / In combination with

Bocchette
 Escutcheons
 P. 240

Chiusure privacy BZG
 Bathroom privacy sets
 P. 252



Disponibile su richiesta **Classe 4** secondo la norma EN 1906.
 Upon request, Class 4 is also available according to EN 1906.
 P. 295



H 380 Antonio Citterio è una maniglia solida e raffinata nella sua assoluta essenzialità formale e si distingue per un design imperniato sul gioco della luce con i volumi. La leva è composta da un'anima cilindrica, avvolta all'altezza dell'impugnatura da una elegante copertura poligonale che garantisce una presa sicura e confortevole. / H 380 Antonio Citterio is solid and sophisticated in its minimalism, with a design that plays with light and volume. The lever is composed of a cylindrical core, wrapped in an elegant polygonal cover at one end to guarantee a secure and comfortable grip.

Materiale / Material

Ottone / Brass

Maniglia porta / Door handle



Cromo
Polished chrome



Cromosat
Satin chrome



Bronzo scuro
Dark bronze

Coordinati / Matches

Finestra / Window handle

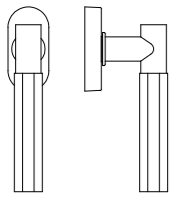

P. 204

Maniglione / Pull handle

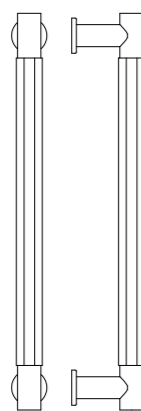

P. 231

In abbinamento sono disponibili / In combination with

Bocchette
Escutcheons
P. 240

Chiusure privacy BZG
Bathroom privacy sets
P. 252



Antonio Citterio H 380

H 379 Antonio Citterio è stata concepita dall'immaginazione dell'architetto e designer milanese e incarna l'unione perfetta di solidità ed eleganza. La leva cilindrica appare ergonomica e compatta: la combinazione di superfici lisce e superfici godronate aggiunge il piacere tattile a quello visivo. / H 379 Antonio Citterio was conceived by the Milanese architect and designer and embodies the perfect union of solidity and elegance. The cylindrical lever is ergonomic and compact while the combination of smooth and knurled surfaces adds tactile pleasure to the visual appeal.

Materiale / Material

Ottone / Brass

Maniglia porta / Door handle



Cromosat
Satin chrome



Bronzop
Matt bronze



Orsator
Matt brass

Coordinati / Matches

Finestra / Window handle

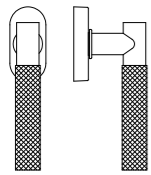

P. 204

Maniglione / Pull handle

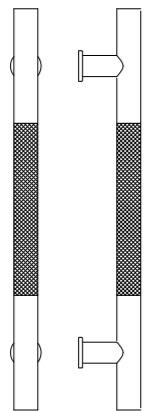

P. 231

In abbinamento sono disponibili / In combination with

Bocchette
Escutcheons
P. 240

Chiusure privacy BZG
Bathroom privacy sets
P. 252



Antonio Citterio **H 379**

H 327 Antonio Citterio è una rivisitazione della maniglia classica che gioca con le prospettive e i punti di vista. Mentre il profilo frontale tende ad allargarsi dal perno verso l'impugnatura, in sezione, al contrario, lo spessore si assottiglia, rendendo la presa più agile e comoda.

H 327 Antonio Citterio plays with perspectives in a revisitation of the classic handle design. While the front profile widens towards the end of the handle, it narrows on the other side, making the grip more agile and ergonomic.

Materiale / Material

Ottone / Brass



Cromosat
Satin chrome



Orolucido
Polished brass

Maniglia porta / Door handle



Coordinati / Matches

Finestra / Window handle

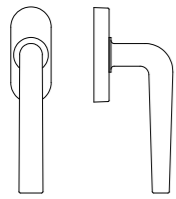

P. 205

In abbinamento sono disponibili / In combination with

Bocchette
Escutcheons
P. 240

Chiusure privacy BZG
Bathroom privacy sets
P. 252



Disponibile su richiesta **Classe 4** secondo la norma EN 1906.
Upon request, Class 4 is also available according to EN 1906.
P. 295

H 317 Antonio Citterio ha un design focalizzato sull'impugnatura dalla morbida forma a goccia che, giocando con la luce e con i volumi, crea riflessi e chiaroscuri di elegante essenzialità. Le linee curve e sinuose si adattano perfettamente alla mano. / H 317 Antonio Citterio is designed around a soft drop-shaped handle that plays with light and volumes to create elegant reflections and contrast. The curved, ergonomic lines perfectly fit the hand.

Materiale / Material
Ottone / Brass

Maniglia porta / Door handle



Cromo
Polished chrome



Cromosat
Satin chrome



Oro lucido
Polished brass

Coordinati / Matches

Finestra / Window handle

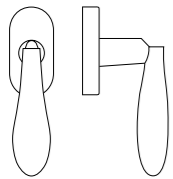

P. 205

In abbinamento sono disponibili / In combination with

Bocchette
Escutcheons
P. 240

Chiusure privacy BZG
Bathroom privacy sets
P. 252



Disponibile su richiesta **Classe 4** secondo la norma EN 1906.
Upon request, Class 4 is also available according to EN 1906.
P. 295



Antonio Citterio **H 317**

H 5015 Antonio Citterio gioca con l'idea di forma primaria in un'unione perfetta di solidità ed eleganza. La leva perfettamente regolare è costituita da due cilindri di sezioni diverse: quello più grande, all'altezza dell'impugnatura, è decorato da piccole losanghe. / H 5015 Antonio Citterio plays with the idea of primary form in a perfect blend of solidity and elegance. The perfectly regular lever is formed of two different cylinders. The larger one, which provides the grip, is decorated with a small diamond pattern.

Materiale / Material

Acciaio inox AISI 316 L
Stainless steel AISI 316 L

Maniglia porta / Door handle

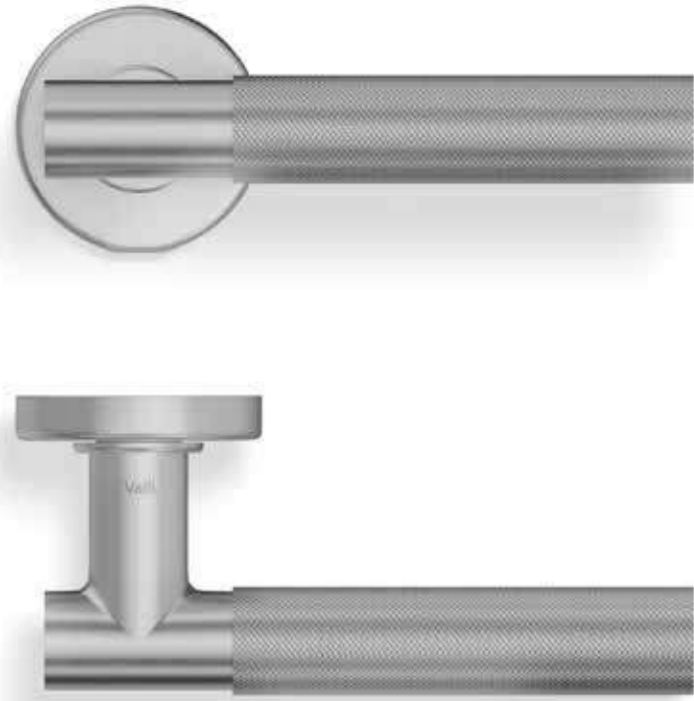

Acciaio inox lucido
Polished stainless steel



Acciaio inox satinato
Satin stainless steel



Acciaio inox satinato
+ Pelle nera
Satin stainless steel +
Black leather



Acciaio inox satinato
+ Pelle arancione
Satin stainless steel +
Orange leather

Coordinati / Matches

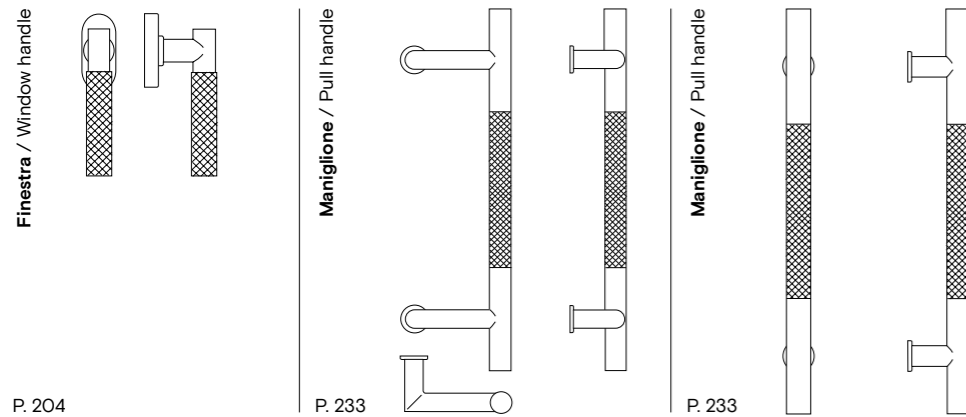

In abbinamento sono disponibili / In combination with

Bocchette
Escutcheons
P. 240

Chiusure privacy BZG
Bathroom privacy sets
P. 252



Disponibile su richiesta **Classe 4** secondo la norma EN 1906.
Upon request, Class 4 is also available according to EN 1906.
P. 295

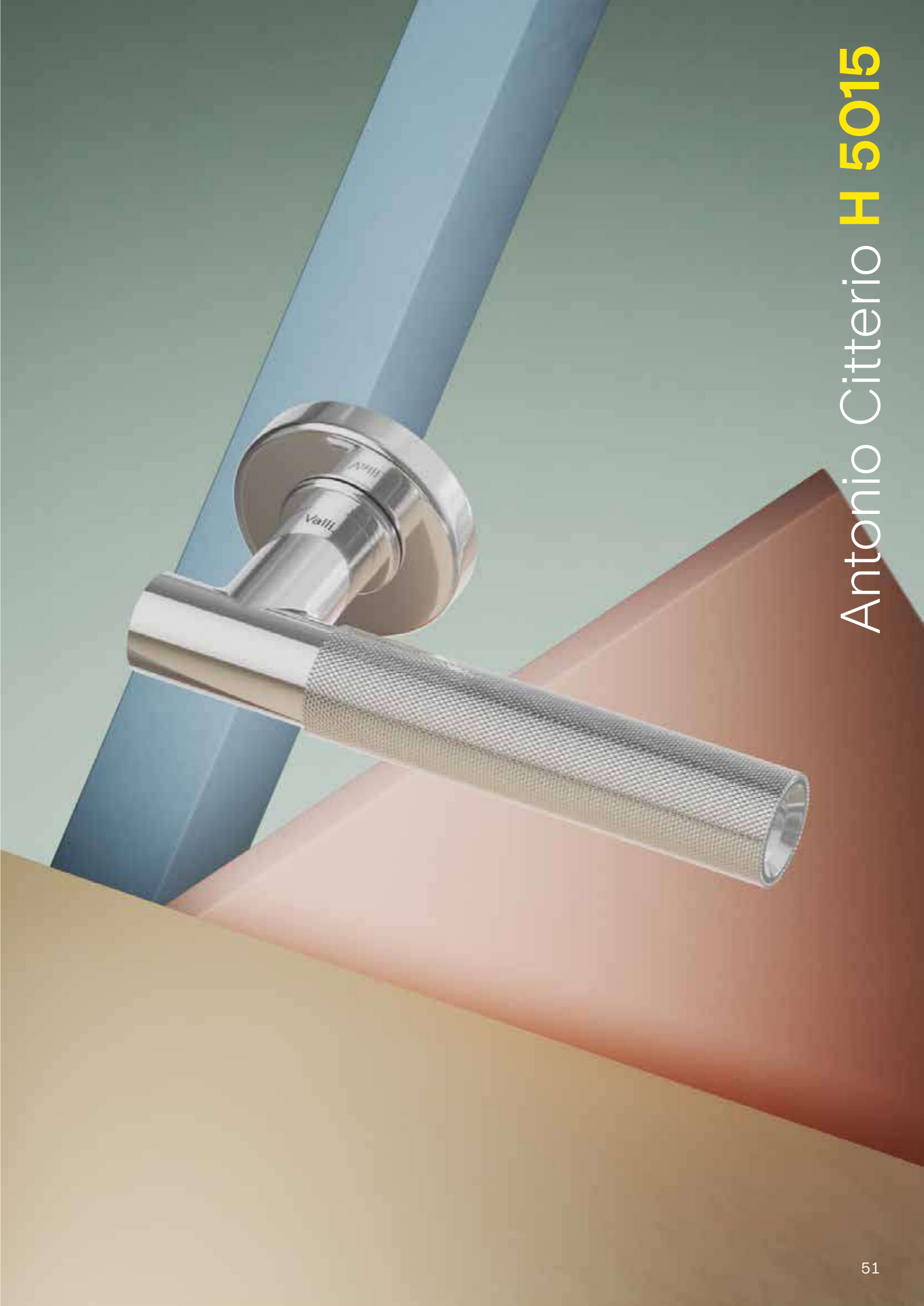

Antonio Citterio H 5015

H 361 Antonio Citterio – Toan Nguyen è una maniglia di grande personalità, creata per esaltare il concetto di geometria primaria. I volumi solidi e regolari sono ammorbiditi dalla dolcezza della piega, dagli spigoli smussati e dal rigonfiamento all'interno dell'impugnatura, che ne facilita la presa. / The H 361 Antonio Citterio – Toan Nguyen handle is a celebration of primary geometry. The regular, solid shape is softened by a gentle bend, rounded edges, and a central bulge on the inside of the handle, which makes it easier to grip.

Materiale / Material

Nikrall Lega Zama UNI 3717

Maniglia porta / Door handle



Cromo
Polished chrome



Cromosat
Satin chrome



Light black
Light black

Coordinati / Matches

Finestra / Window handle

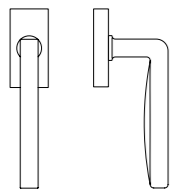

P. 205

Maniglione / Pull handle

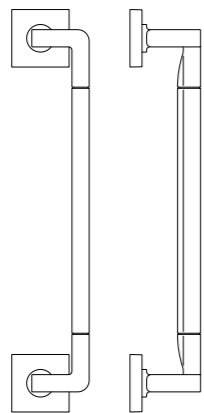

P. 232

In abbinamento sono disponibili / In combination with

Bocchette
Escutcheons
P. 240

Chiusure privacy BZG
Bathroom privacy sets
P. 252



Antonio Citterio – Toan Nguyen **H 361**

H 1066 Bertone Design rielabora per astrazione il lampo della mitologia olimpica disegnando una silhouette semplice e geometrica, composta da rette e angoli netti che danno vita a una maniglia straordinariamente ergonomica, dalle linee forti, decise e razionali.

H 1066 Bertone Design reworks Zeus's lightning bolt into a simple, geometric silhouette formed of straight lines and severe angles that strictly comply with the rules of the golden ratio. The result is an extraordinarily ergonomic handle, with a strong and decisive shape.

Materiale / Material

Ottone / Brass



Cromosat
Satin chrome



Nikelhero
Black nickel



Orsatop
Matt brass

Maniglia porta / Door handle

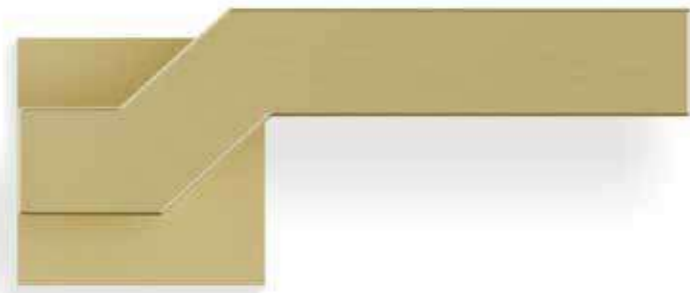

Coordinati / Matches

Finestra / Window handle

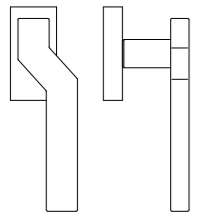

P. 205

In abbinamento sono disponibili / In combination with

Bocchette
Escutcheons
P. 240

Chiusure privacy BZG
Bathroom privacy sets
P. 252

La serie H 368 Cerri & Associati celebra l'idea di riflesso e luminosità. Le linee curve e morbide dell'impugnatura ovale diffondono perfettamente la luce, messa ancora più in risalto dalle finiture argentee che conferiscono personalità ed eleganza alla maniglia.

The H 368 Cerri & Associati series celebrates the idea of radiance and reflection. The soft, curved lines of the oval handle perfectly diffuse the light, emphasised even further by the silver finishes. The result embodies personality and elegance.

Materiale / Material

Ottone / Brass



Cromo
Polished chrome



Cromosat
Satin chrome

Maniglia porta / Door handle



Coordinati / Matches

Finestra / Window handle

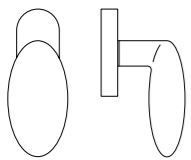

P. 206

In abbinamento sono disponibili / In combination with

Bocchette
Escutcheons
P. 240

Chiusure privacy BZG
Bathroom privacy sets
P. 252



Disponibile su richiesta **Classe 4** secondo la norma EN 1906.
Upon request, Class 4 is also available according to EN 1906.
P. 295

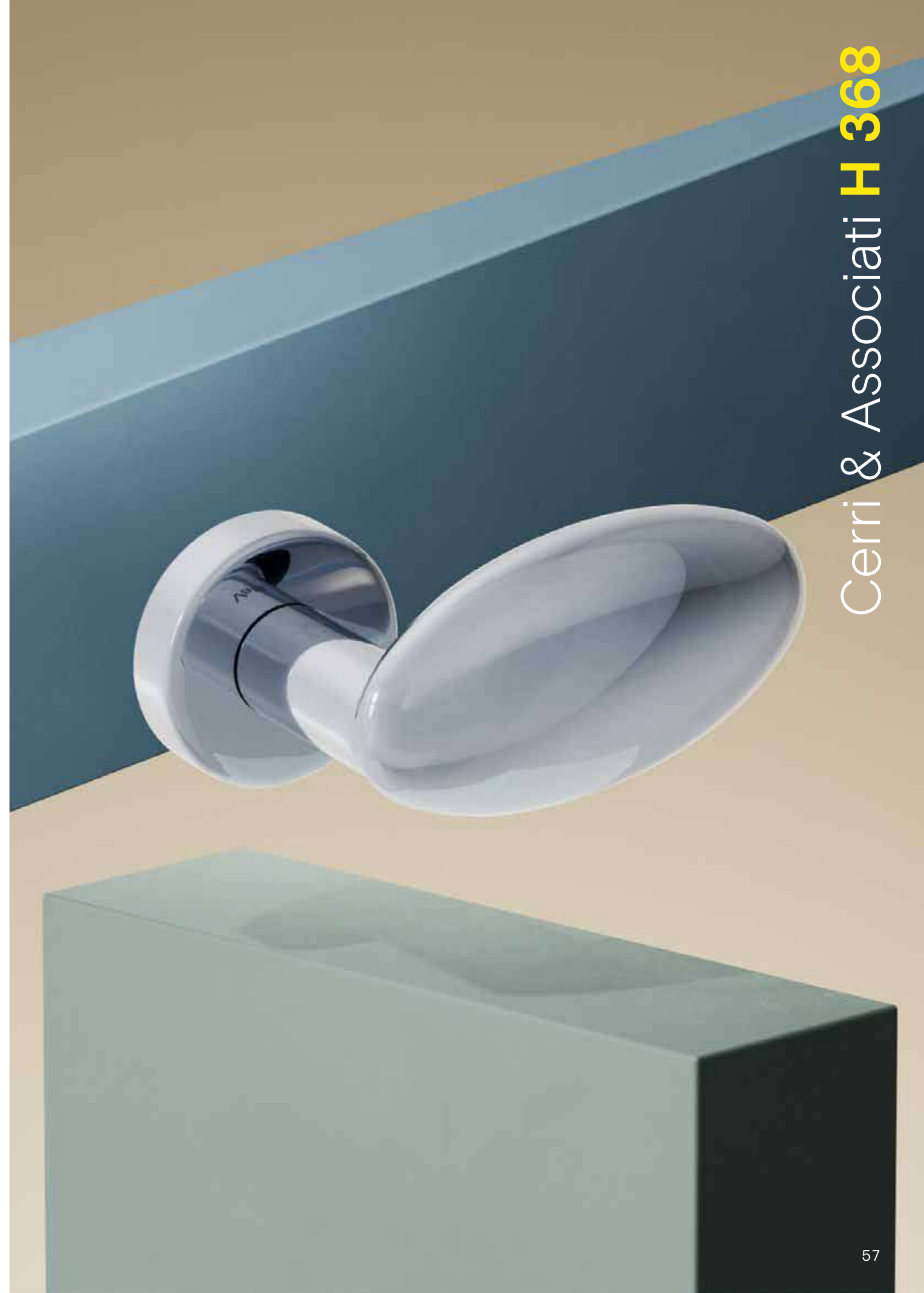

Il concept di H 384 CetraRuddy Architecture D.P.C. è ispirato alla cinetica della stretta di mano: l'impugnatura si sviluppa in una torsione di superfici inclinate, di spigoli smussati e di angoli netti che generano un design dinamico ed ergonomico, fluido e piacevole alla presa.
 The H 384 CetraRuddy Architecture D.P.C. concept is inspired by the kinetics of a handshake: the lines of the handle develop in a twist of inclined surfaces, rounded edges, and sharp angles that form a dynamic and ergonomic design that is both fluid and pleasant to grip.

Materiale / Material

Ottone / Brass

Maniglia porta / Door handle



Cromosat
Satin chrome



Bronzo scuro
Dark bronze



Neropaco
Matt black

Coordinati / Matches

Finestra / Window handle

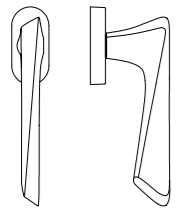

P. 206

In abbinamento sono disponibili / In combination with

Bocchette
Escutcheons
P. 240

Chiusure privacy BZG
Bathroom privacy sets
P. 252



CetraRuddy Architecture D.P.C. H 384

H 348 David Chipperfield manifesta perfettamente l'estetica rarefatta e raffinata del suo progettista. La forma affusolata ed essenziale si assottiglia verso l'estremità dell'impugnatura. Gli spigoli arrotondati e le superfici stondate lasciano scivolare la luce, fornendo una presa perfetta alla mano.

H 348 David Chipperfield perfectly manifests the designer's subtle and sophisticated aesthetic. The minimal, tapered shape narrows towards the end, creating an elusive and elegant profile. The rounded edges and smooth surfaces allow light through while providing the perfect grip.

Maniglia porta / Door handle



Materiale / Material

Ottone / Brass



Cromo
Polished chrome



Cromosat
Satin chrome

Coordinati / Matches

Finestra / Window handle

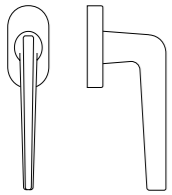

P. 206

In abbinamento sono disponibili / In combination with

Bocchette
Escutcheons
P. 240

Chiusure privacy BZG
Bathroom privacy sets
P. 252



Disponibile su richiesta **Classe 4** secondo la norma EN 1906.
Upon request, Class 4 is also available according to EN 1906.
P. 295

H 1061 Di Virgilio Veneziano è una maniglia in equilibrio tra due mondi e due tempi. Il design reinterpreta l'archeologia emotiva della classica maniglia sagomata, tagliata in sezione con un gesto che la rende immediatamente astratta e contemporanea. / H 1061 Di Virgilio Veneziano balances two different worlds and eras. The emotional archaeology of the classic shaped handle is redeveloped into an abstract and current design.

Materiale / Material
Ottone / Brass

Maniglia porta / Door handle

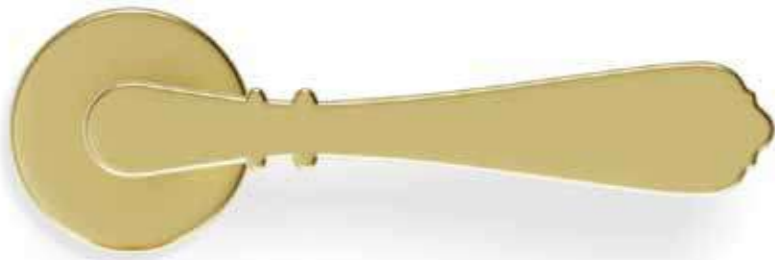

Bronzop
Matt bronze



Light black
Light black



Orsatin
Satin brass

Coordinati / Matches

Finestra / Window handle

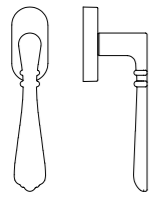

P. 206

Pomolo / Door knob

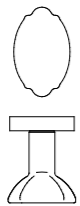

P. 225

Maniglione / Pull handle

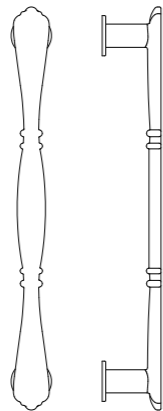

P. 236

In abbinamento sono disponibili / In combination with

Bocchette
Escutcheons
P. 240

Chiusure privacy BZG
Bathroom privacy sets
P. 252

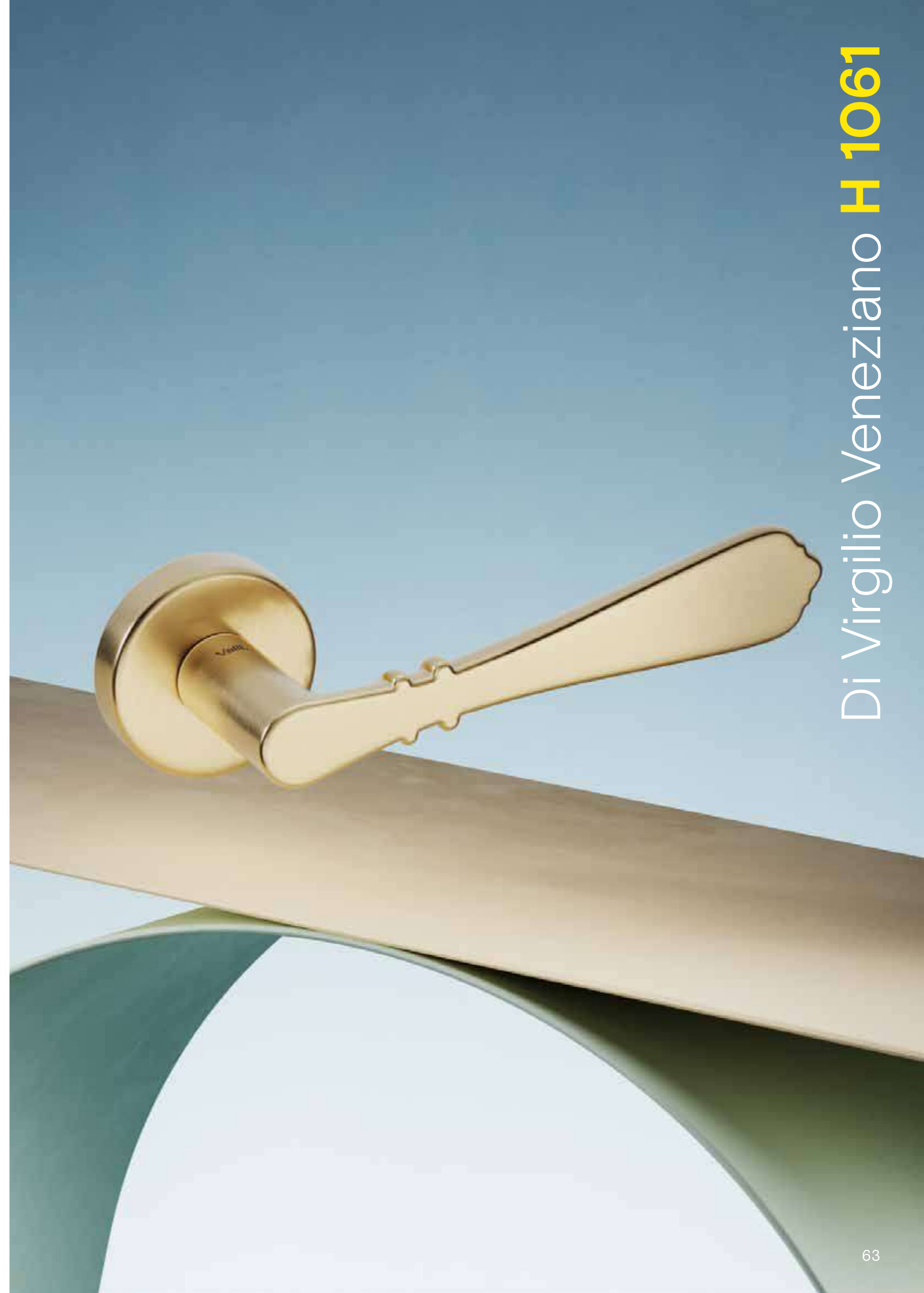

Di Virgilio Veneziano **H 1061**

Il concept di H 370 Doriana e Massimiliano Fuksas è un omaggio al razionalismo della cultura classica mediterranea e unisce la rigorosa esattezza di un profilo liscio e geometrico alla decorazione dell'impugnatura, la cui superficie presenta scanalature e ondulazioni che richiamano la colonna dorica. / The concept behind H 370 Doriana e Massimiliano Fuksas is a tribute to the rationalism typical of classical Mediterranean architecture and combines a perfectly smooth and geometric profile with a decorated handle, whose grooved and undulating surface recalls a doric column.

Materiale / Material
Ottone / Brass

Maniglia porta / Door handle

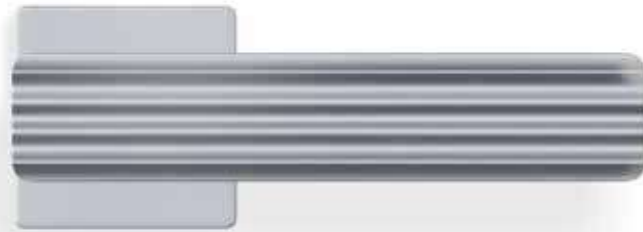

Cromo
Polished chrome



Cromosat
Satin chrome

Coordinati / Matches

Finestra / Window handle

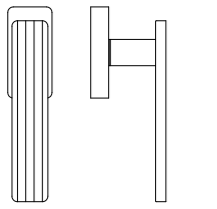

P. 207

In abbinamento sono disponibili / In combination with

Bocchette
Escutcheons
P. 240

Chiusure privacy BZG
Bathroom privacy sets
P. 252



Disponibile su richiesta **Classe 4** secondo la norma EN 1906.
Upon request, Class 4 is also available according to EN 1906.
P. 295

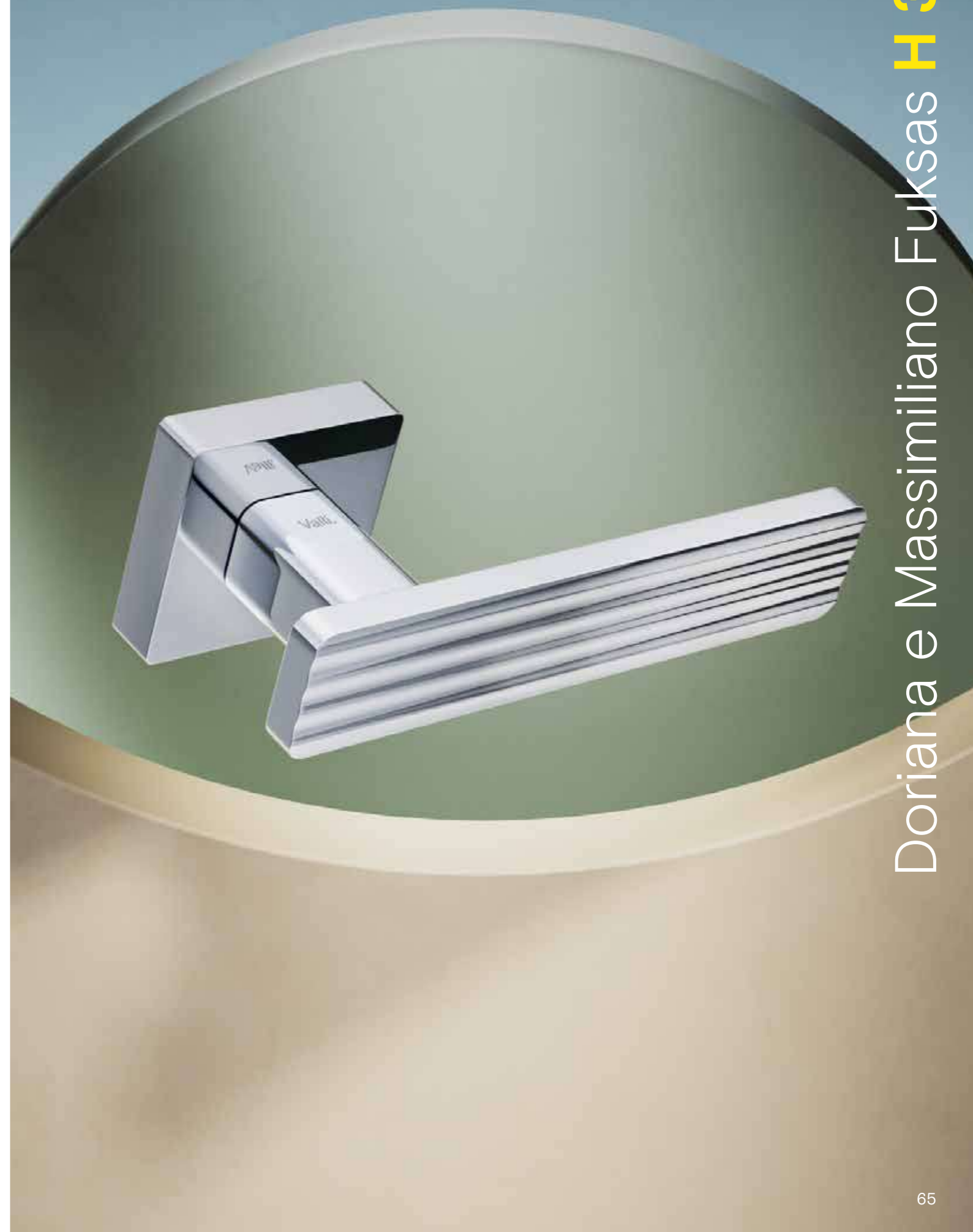

Doriana e Massimiliano Fuksas **H 370**

H 198 Eero Aarnio è una maniglia pensata per enfatizzare al massimo i principi dell'ergonomia senza rinunciare al garbo e all'eleganza. La linea della leva si sviluppa arcuata, morbida e avvolgente, permettendo una presa agevole e sicura, disegnando al tempo stesso uno stile delicato e senza tempo. / H 198 Eero Aarnio was conceived by the Finnish designer to maximise ergonomics without sacrificing grace and elegance. The handle is gently arched for a firm and pleasant grip, while simultaneously offering delicate and timeless style.

Materiale / Material
Ottone / Brass

Maniglia porta / Door handle



Cromosat
Satin chrome



Anticato
Antique



Orlucido
Polished brass



Orsatin
Satin brass

Coordinati / Matches

Finestra / Window handle

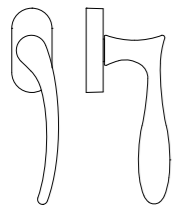

P. 207

Maniglione / Pull handle

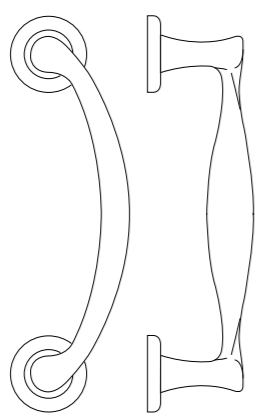

P. 235

In abbinamento sono disponibili / In combination with

Bocchette
Escutcheons
P. 240

Chiusure privacy BZG
Bathroom privacy sets
P. 252



Disponibile su richiesta **Classe 4** secondo la norma EN 1906.
Upon request, Class 4 is also available according to EN 1906.
P. 295



H 372 Eri Goshen enfatizza il concetto di forma geometrica dinamica. L'impugnatura squadrata e regolare della maniglia compie una rotazione su sé stessa in un movimento di torsione che genera volumi fluidi e giochi di luce sulle superfici. / For H 372 Eri Goshen, the Israeli designer emphasises the concept of dynamic geometric form. The regular, squared handle twists on itself in a fluid movement that generates a play of light on the surface.

Materiale / Material

Ottone / Brass



Cromo
Polished chrome



Cromosat
Satin chrome

Maniglia porta / Door handle



Coordinati / Matches

Finestra / Window handle

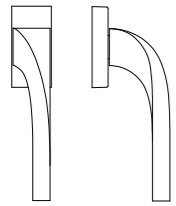

P. 207

In abbinamento sono disponibili / In combination with

Bocchette
Escutcheons
P. 240

Chiusure privacy BZG
Bathroom privacy sets
P. 252



Disponibile su richiesta **Classe 4** secondo la norma EN 1906.
Upon request, Class 4 is also available according to EN 1906.
P. 295

H 385 Federica Biasi è ispirata alla morfologia organica della natura con un design che evoca la bellezza e la semplicità di un ramo. La forma sinuosa, gentile, estremamente equilibrata della sua silhouette, supporta una funzionalità e un'ergonomia incredibilmente confortevoli.
 H 385 Federica Biasi is inspired by the organic morphology of nature with a design that evokes the simple beauty of a branch. The sinuous, gentle, and extremely balanced silhouette offers incredible comfort, functionality, and ergonomics.

Materiale / Material

Nikrall Lega Zama UNI 3717

Maniglia porta / Door handle



Cromo
Polished chrome



Cromosat
Satin chrome



Neropaco
Matt black



Nikeinero
Black nickel

Coordinati / Matches

Finestra / Window handle

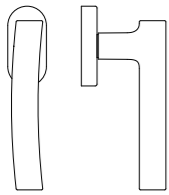

P. 207

Maniglione / Pull handle

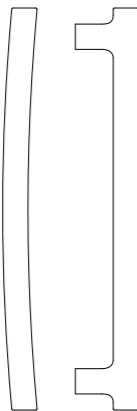

P. 230

In abbinamento sono disponibili / In combination with

Bocchette
Escutcheons
P. 240

Chiusure privacy BZG
Bathroom privacy sets
P. 252

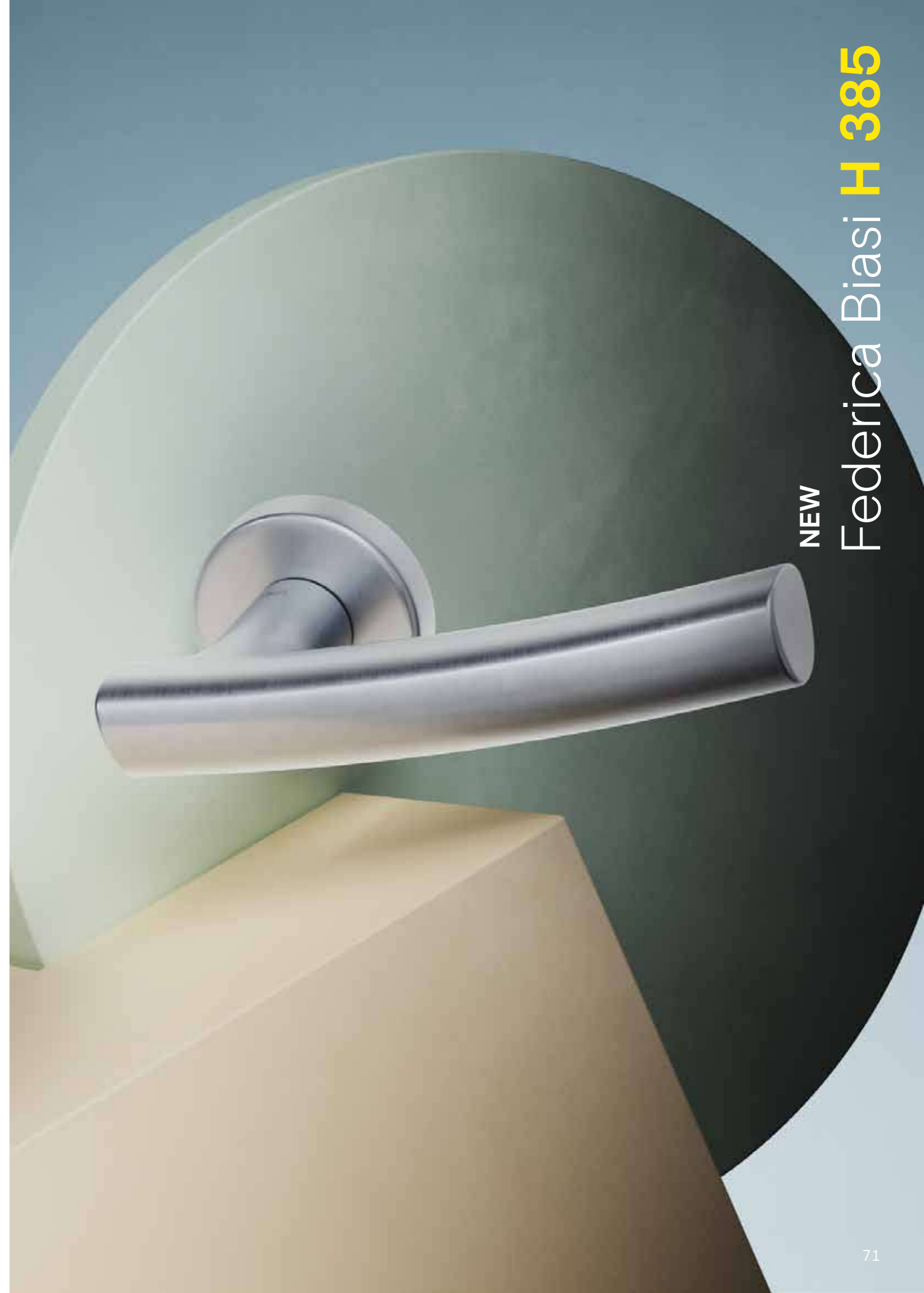

NEW

Federica Biasi H 385

H 334 Foster + Partners è una maniglia dal design flessuoso e armonioso, sviluppato con linee curve e fluide. L'impugnatura morbida si piega in un'elaborata onda che si gira su sé stessa creando un dinamismo raffinato e una superficie levigata che genera eleganti giochi di luce. / H 334 Foster + Partners boasts a supple and harmonious design that develops with curved and fluid lines. The soft grip bends in an elaborate wave, creating movement and a smooth surface that generates elegant plays of light.

Materiale / Material

Ottone / Brass**Cromosat**
Satin chrome**Oro lucido**
Polished brass

Maniglia porta / Door handle



Coordinati / Matches

Finestra / Window handle

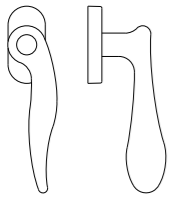

P. 208

In abbinamento sono disponibili / In combination with

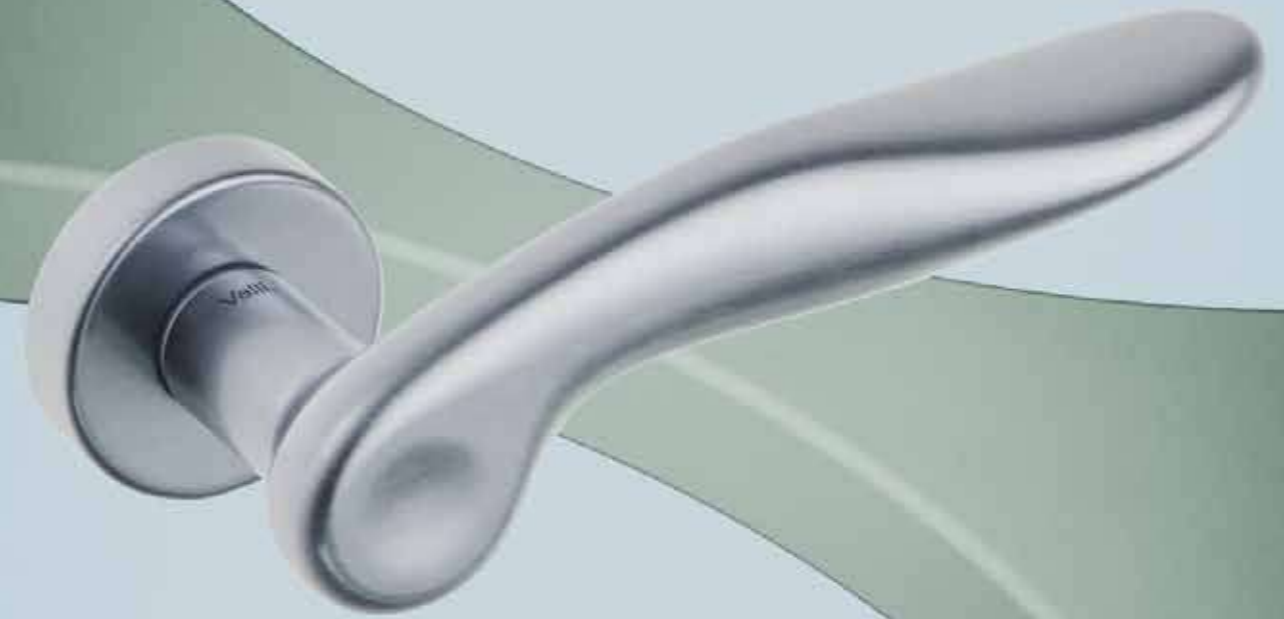
Bocchette
Escutcheons
P. 240**Chiusure privacy BZG**
Bathroom privacy sets
P. 252**Disponibile su richiesta Classe 4 secondo la norma EN 1906.**
Upon request, Class 4 is also available according to EN 1906.
P. 295

H 374 Franco Poli si presenta come una scultura aerodinamica di asciutta essenzialità e di un'eleganza vagamente retrò. La piastra frontale dell'impugnatura, di forma ellittica, è personalizzabile al suo interno con intarsi di finiture diverse. / H 374 Franco Poli resembles a minimal aerodynamic sculpture and boasts a vaguely retro elegance. The front plate, elliptical in shape, can be customised with inlays of different finishes.

Materiale / Material

Ottone / Brass

Maniglia porta / Door handle



Cromosat
Satin chrome



Orsatop
Matt brass



**Cromosat +
Inserito grezzo**
Satin chrome +
Raw insert



**Cromosat +
Inserito gofrato nero**
Satin chrome + Black
embossed insert



**Orsatop +
Inserito grezzo**
Matt brass +
Raw insert



**Orsatop +
Inserito gofrato nero**
Matt brass + Black
embossed insert

Coordinati / Matches

Finestra / Window handle

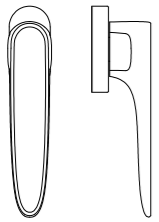

P. 208

Pomolo / Door knob

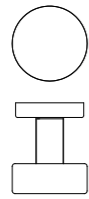

P. 225

In abbinamento sono disponibili / In combination with

Bocchette
Escutcheons
P. 240

Chiusure privacy BZG
Bathroom privacy sets
P. 252



H 1040 Gabriele e Oscar Buratti è una maniglia di ispirazione razionale, elegante e dal carattere deciso, che si sviluppa intorno al tema della solidità e della geometria. Sull'impugnatura due facce piate si uniscono in un angolo appena accennato, ma capace di creare giochi volumetrici percepibili al tatto oltre che alla vista. / H 1040 Gabriele and Oscar Buratti is a strong, elegant and functional handle inspired by solidity and geometry. Two flat surfaces come together at a slight angle to form the handle, creating a play of volumes perceptible both visually and to the touch.

Materiale / Material

Ottone / Brass

Maniglia porta / Door handle

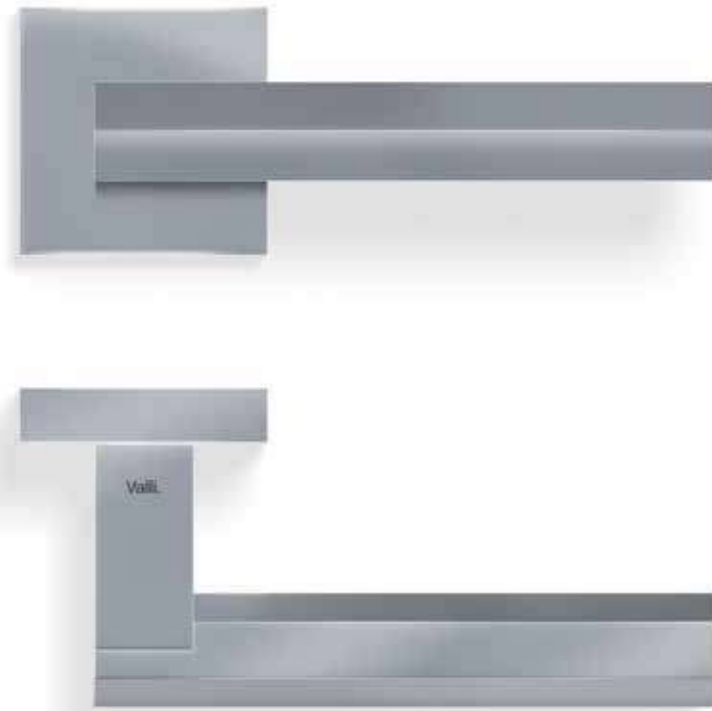
**Cromo**
Polished chrome**Cromosat**
Satin chrome**Bronzsat**
Bronzsat

Coordinati / Matches

Finestra / Window handle

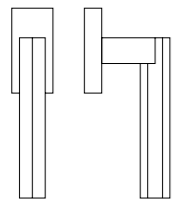

P. 208

In abbinamento sono disponibili / In combination with

Bocchette
Escutcheons
P. 240**Chiusure privacy BZG**
Bathroom privacy sets
P. 252

H 376 Giancarlo Vegni è stata concepita come un gioco di volumetrie in movimento. Il design lineare dell'impugnatura è interrotto da un avvallamento che ne modifica la forma, lasciando integra l'idea della solidità, ma imprimendo dinamismo alla maniglia.

H 376 Giancarlo Vegni was conceived as a play of moving parts. The linear design is interrupted halfway along by a depression in the metal body that alters the shape, leaving the idea of solidity intact but adding dynamism.

Materiale / Material

Ottone / Brass

Maniglia porta / Door handle

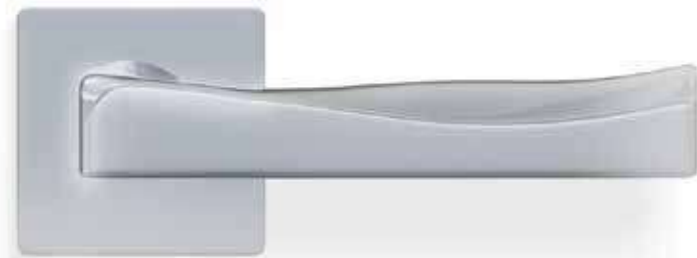

Cromo
Polished chrome



Cromosat
Satin chrome



Cromo / Cromosat
Polished chrome /
Satin chrome

Coordinati / Matches

Finestra / Window handle

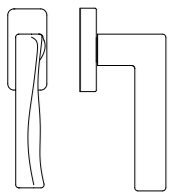

P. 208

Pomolo / Door knob

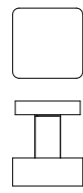

P. 225

In abbinamento sono disponibili / In combination with

Bocchette
Escutcheons
P. 240

Chiusure privacy BZG
Bathroom privacy sets
P. 252



Disponibile su richiesta **Classe 4** secondo la norma EN 1906.
Upon request, Class 4 is also available according to EN 1906.
P. 295



Giancarlo Vegni **H 376**

H 367 Giancarlo Vegni è stata concepita come un gioco di volumetrie in movimento. Il design lineare dell'impugnatura si modifica nella parte finale con un lieve avvallamento del corpo metallico che ne altera la forma, lasciando integra l'idea della solidità, ma imprimendo dinamismo alla maniglia. / H 367 Giancarlo Vegni was conceived as a play of moving parts. The linear handle design features a slight depression at one end, which completely alters the shape, leaving the idea of solidity intact but adding dynamism.

Materiale / Material

Ottone / Brass



Cromo
Polished chrome



Cromosat
Satin chrome

Maniglia porta / Door handle

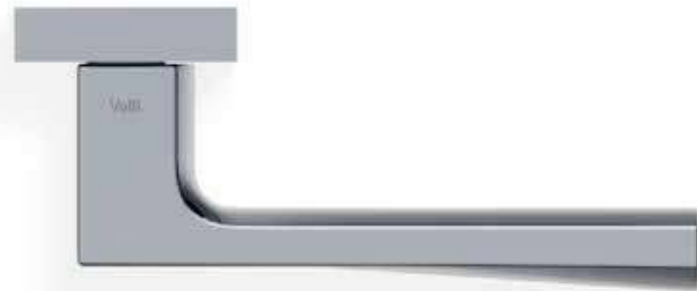

Coordinati / Matches

Finestra / Window handle

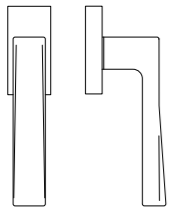

P. 209

In abbinamento sono disponibili / In combination with

Bocchette
Escutcheons
P. 240

Chiusure privacy BZG
Bathroom privacy sets
P. 252



Disponibile su richiesta **Classe 4 secondo la norma EN 1906.**
Upon request, Class 4 is also available according to EN 1906.
P. 295

H 5017 Hans Kollhoff ha nella semplicità e nel rigore il focus del suo stile. Un parallelepipedo regolare, stondato nella parte frontale, disegna l'impugnatura con eleganza minimale e grande comfort nella presa. / H 5017 Hans Kollhoff is designed around simplicity and precision. A regular parallelepiped, rounded at the front, forms a handle that boasts minimal elegance and a highly comfortable grip.

Materiale / Material

Acciaio inox AISI 316 L
Stainless steel AISI 316 L



Acciaio inox lucido
Polished stainless steel



Acciaio inox satinato
Satin stainless steel

Maniglia porta / Door handle

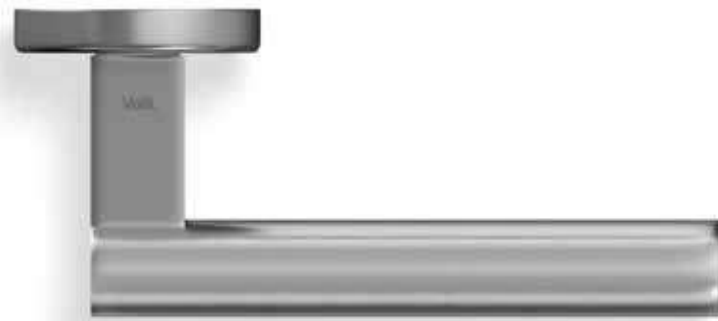
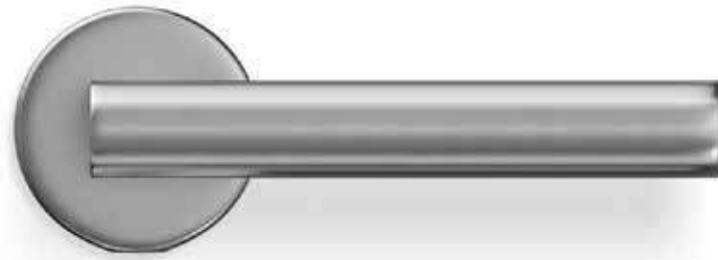

Coordinati / Matches

Finestra / Window handle

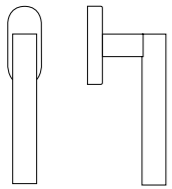

P. 209

In abbinamento sono disponibili / In combination with

Bocchette
Escutcheons
P. 240

Chiusure privacy BZG
Bathroom privacy sets
P. 252



Disponibile su richiesta **Classe 4** secondo la norma EN 1906.
Upon request, Class 4 is also available according to EN 1906.
P. 295



Hans Kollhoff **H 5017**

H 1039 Jean-Baptiste Sibertin Blanc propone una raffinata rivisitazione del concetto di maniglia classica lavorando con grande finezza sulla plasticità dei volumi. La lama piatta e morbida subisce una lieve torsione all'altezza del perno mentre l'impugnatura si allarga verso la punta, per una presa agile ed ergonomica.
 H 1039 Jean-Baptiste Sibertin Blanc elegantly reinterprets the concept of the classic handle, redeveloping the shape of the volumes with great finesse. The flat handle with rounded edges twists slightly at the spindle and widens dynamically towards the tip, for an agile and ergonomic grip.

Materiale / Material

Ottone / Brass

Cromosat / Cromo
Satin chrome /
Polished chrome



Oro lucido
Polished brass

Maniglia porta / Door handle



Coordinati / Matches

Finestra / Window handle

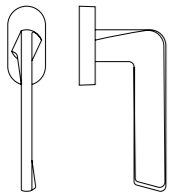

P. 209

Maniglione / Pull handle

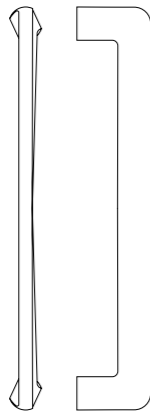

P. 234

In abbinamento sono disponibili / In combination with

Bocchette
Escutcheons
P. 240

Chiusure privacy BZG
Bathroom privacy sets
P. 252



Disponibile su richiesta **Classe 4** secondo la norma EN 1906.
Upon request, Class 4 is also available according to EN 1906.
P. 295

H 382 Joe Cheng porta la firma del grande designer cinese. Il minimalismo essenziale, il design pulito e privo di spigoli, la simbiosi equilibrata e solida tra rette e curve, sono espressione della sensibilità orientale di Cheng, reinterpretata in una logica funzionale contemporanea. / The H 382 Joe Cheng handle embodies the signature style of the renowned Chinese designer. Extreme minimalism, a clean rounded design, and the solid balance of straight lines and curves all convey Cheng's sensibility, reinterpreted in a functional and contemporary design.

Materiale / Material
Ottone / Brass

Maniglia porta / Door handle



Bronzop
Matt bronze



Orantop
Antique matt gold



Tortora
Dove grey

Coordinati / Matches

Finestra / Window handle

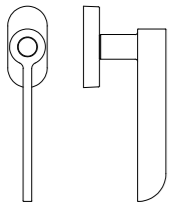

P. 209

In abbinamento sono disponibili / In combination with

Bocchette
Escutcheons
P. 240

Chiusure privacy BZG
Bathroom privacy sets
P. 252



Disponibile su richiesta **Classe 4** secondo la norma EN 1906.
Upon request, Class 4 is also available according to EN 1906.
P. 295



Joe Cheng **H 382**

H 343 John Pawson è una maniglia ispirata a un minimalismo radicale e utilizza forme prime come il cerchio e il rettangolo. Alle curve della rosetta e del perno si connette il volume della leva, costituito da un sottile e allungato parallelepipedo i cui spigoli smussati rendono la presa sicura. / H 343 John Pawson was inspired by radical minimalism and uses basic shapes such as the circle and the rectangle. The lever is formed by a thin and elongated parallelepiped that connects to the curves of the rose and the spindle. Slightly rounded edges ensure a soft and secure grip.

Materiale / Material
Ottone / Brass

Maniglia porta / Door handle



Cromo
Polished chrome



Cromosat
Satin chrome

Coordinati / Matches

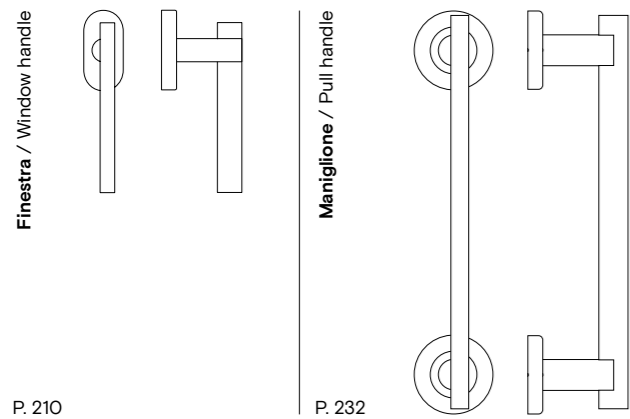

In abbinamento sono disponibili / In combination with

Bocchette
Escutcheons
P. 240

Chiusure privacy BZG
Bathroom privacy sets
P. 252

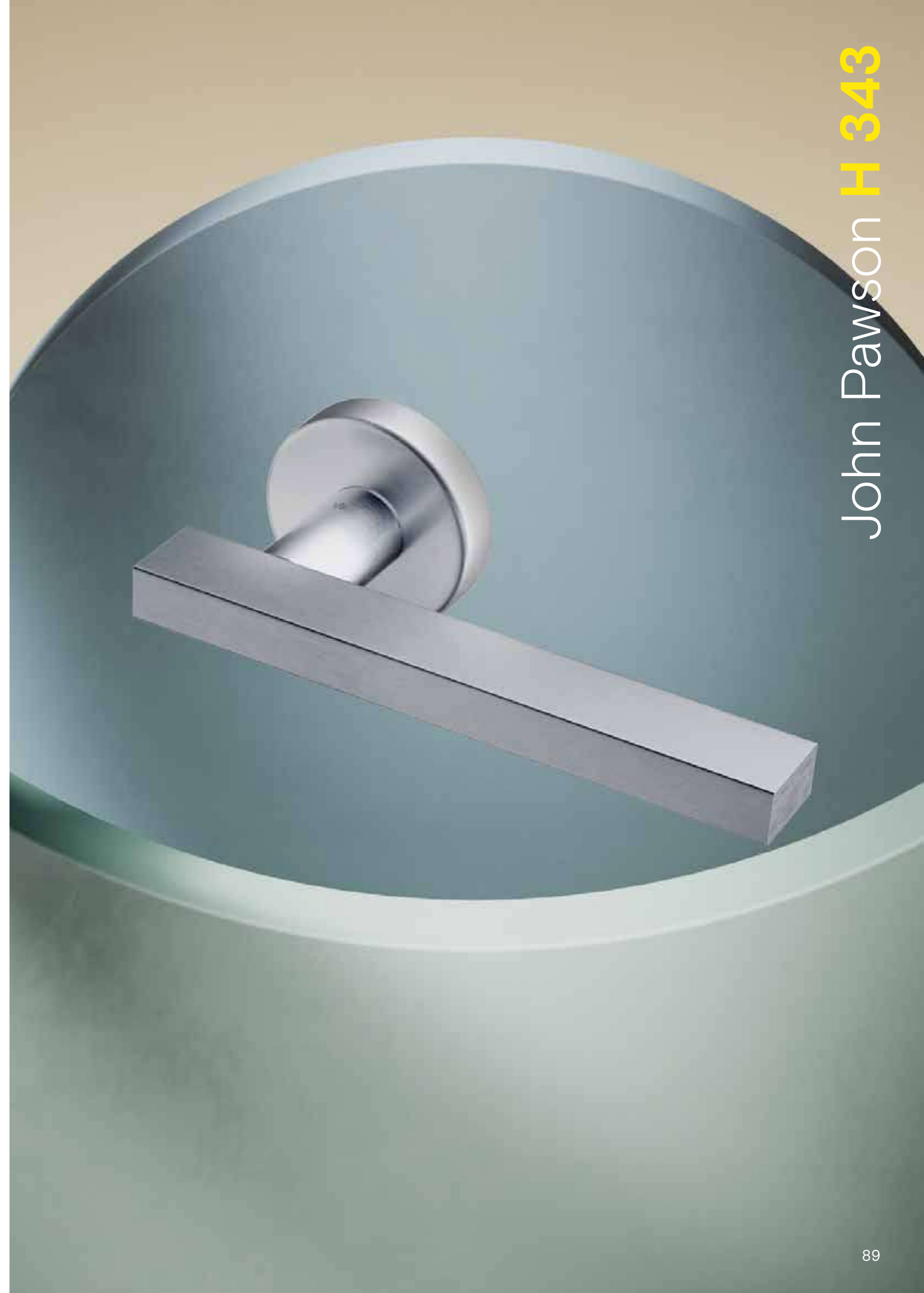

John Pawson H 343

H 381 Khalid Al Najjar è una maniglia sofisticata, che combina design contemporaneo e suggestioni mediorientali. Il profilo discreto dell'impugnatura rivela una personalità inaspettata in sezione, animata da linee curve e garbate che danno vita a un sottile gioco di luci e ombre. / H 381 Khalid Al Najjar is a very sophisticated handle that blends contemporary design elements and Middle Eastern nuances. The discreet, horizontal profile of the handle hides unexpected personality, animated by graceful and curved lines that create a subtle play of light and shadow.

Materiale / Material

Ottone / Brass

Maniglia porta / Door handle



Cromosat
Satin chrome



Nikelnero
Black nickel



Orsatop
Matt brass



Titanium PVD
Titanium PVD

Coordinati / Matches

Finestra / Window handle

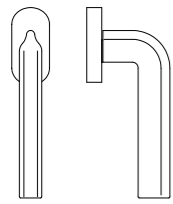

P. 210

Maniglione / Pull handle

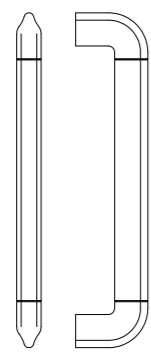

P. 230

In abbinamento sono disponibili / In combination with

Bocchette
Escutcheons
P. 240

Chiusure privacy BZG
Bathroom privacy sets
P. 252



Disponibile su richiesta **Classe 4** secondo la norma EN 1906.
Upon request, Class 4 is also available according to EN 1906.
P. 295

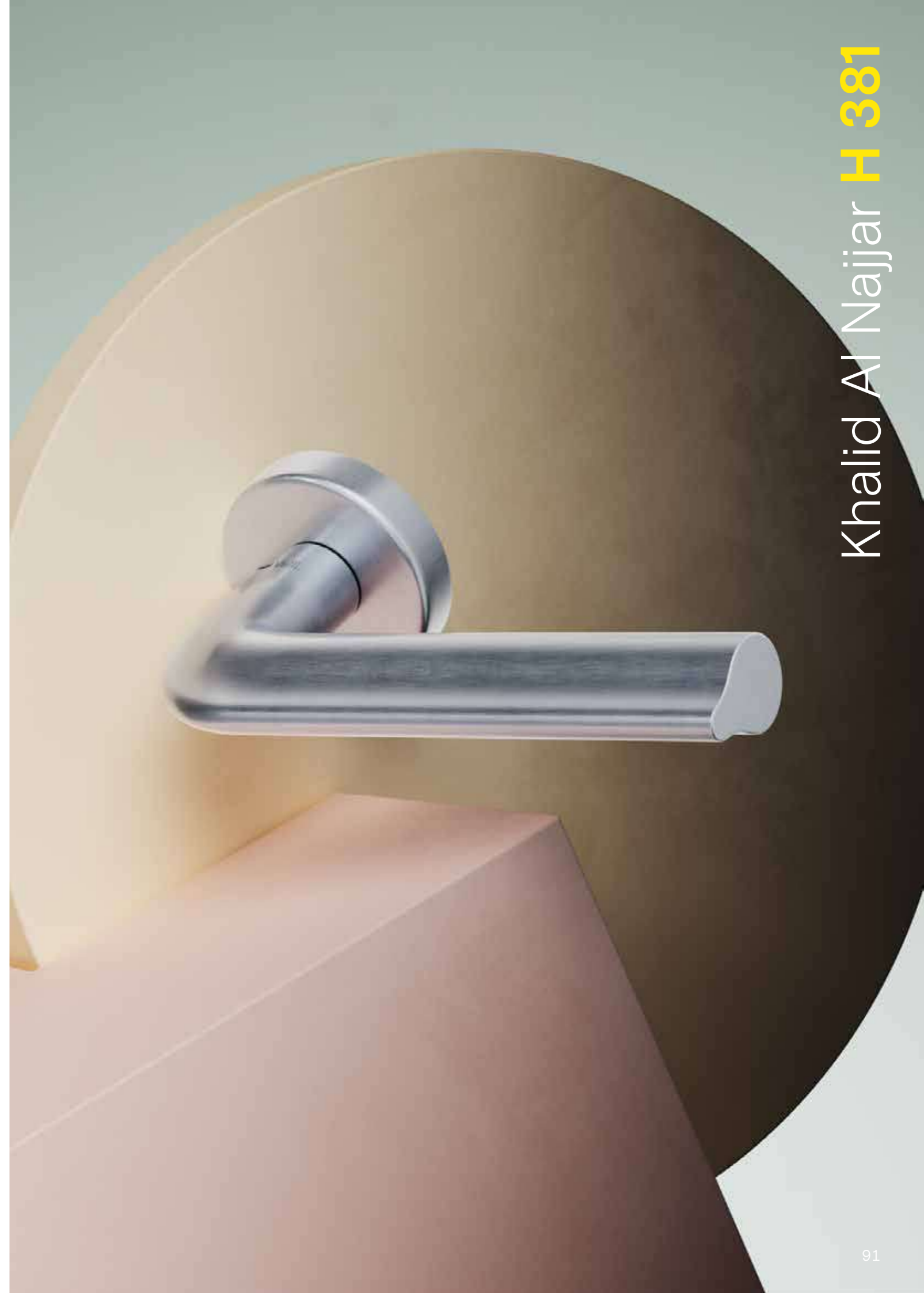

Khalid Al Najjar **H 381**

H 364 Mario Bellini è pensata per unire sapientemente estetica e funzionalità. La linea squadrata e la forma geometrica trasmettono alla maniglia carattere e solennità. All'altezza del perno il volume regolare della leva si restringe creando lo spazio per accogliere la presa della mano. / H 364 Mario Bellini was designed to skilfully combine aesthetics and functionality. The square line and geometric shape give the handle character and solemnity. The handle narrows near the spindle to create the space needed to comfortably accommodate the hand.

Materiale / Material
Ottone / Brass

Maniglia porta / Door handle

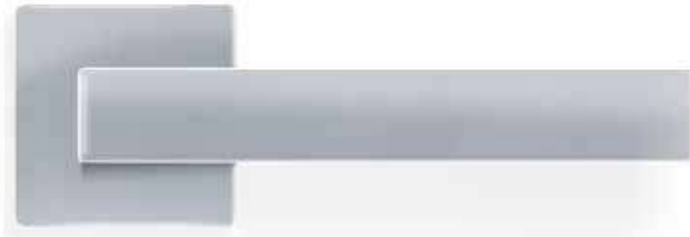

Cromo
Polished chrome



Cromosat
Satin chrome

Coordinati / Matches

Finestra / Window handle

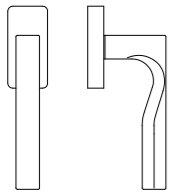

P. 210

In abbinamento sono disponibili / In combination with

Bocchette
Escutcheons
P. 240

Chiusure privacy BZG
Bathroom privacy sets
P. 252



Disponibile su richiesta **Classe 4** secondo la norma EN 1906.
Upon request, Class 4 is also available according to EN 1906.
P. 295

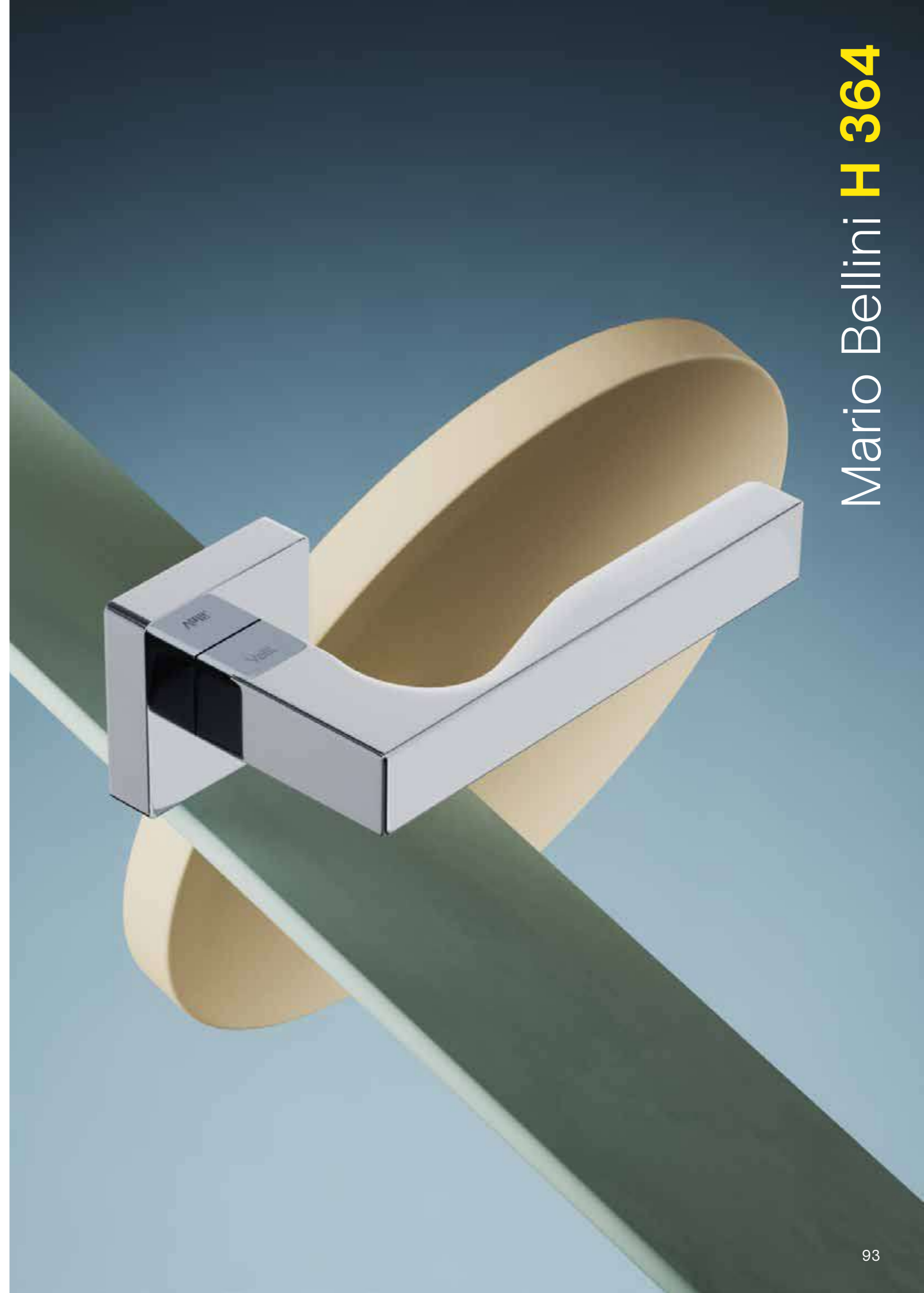

Mario Bellini **H 364**

H 311 Mario Bellini è caratterizzata da linee squadrate che conferiscono solennità e carattere alla maniglia. La solida leva regolare si assottiglia nella parte più vicina al perno per creare uno spazio di invito alla mano e facilitare il movimento di apertura. / H 311 Mario Bellini is characterised by square lines that give the handle solemnity and character. The solid and regular lever tapers towards the spindle to create an inviting space for the hand and to facilitate opening.

Materiale / Material
Ottone / Brass

Maniglia porta / Door handle

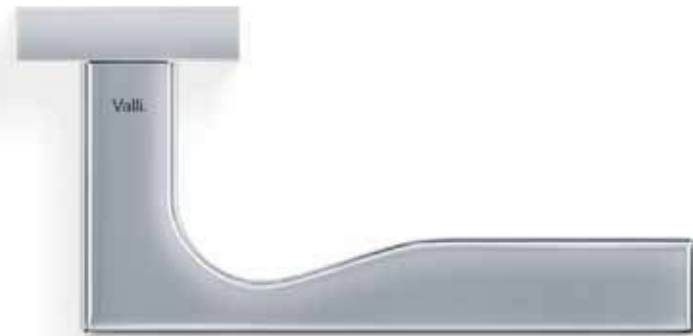

Cromo
Polished chrome



Cromosat
Satin chrome

Coordinati / Matches

Finestra / Window handle

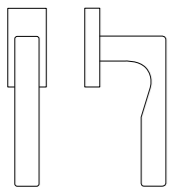

P. 210

In abbinamento sono disponibili / In combination with

Bocchette
Escutcheons
P. 240

Chiusure privacy BZG
Bathroom privacy sets
P. 252



Disponibile su richiesta **Classe 4** secondo la norma EN 1906.
Upon request, Class 4 is also available according to EN 1906.
P. 295



Mario Bellini **H 311**

H 1043 Matteo Thun si presenta nelle sue linee semplici, pulite e morbide, dalla classe senza tempo. La sagoma della leva, dalla forma lievemente stondata, è concava nella parte frontale permettendo alla luce di scivolare al suo interno e di generare un sottile gioco di ombre e di volumi. / H 1043 Matteo Thun boasts clean, soft, and simple lines in an elegant and sober style with timeless class. The front of the slightly rounded lever is concave, allowing the light to generate a subtle play of shadows and volumes.

Materiale / Material

Nikrall Lega Zama UNI 3717



Cromo / Cromosat
Polished chrome /
Satin chrome



Orolux / Orsatin
Polished brass
(for zinc alloy) /
Satin brass

Maniglia porta / Door handle



Coordinati / Matches

Finestra / Window handle

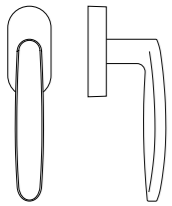

P. 211

In abbinamento sono disponibili / In combination with

Bocchette
Escutcheons
P. 240

Chiusure privacy BZG
Bathroom privacy sets
P. 252

H 1003 Matteo Thun è un elogio del volume curvo. La superficie arcuata dell'impugnatura si sviluppa in una morbida onda che si alza e si abbassa, conferendo movimento e tridimensionalità alla maniglia che diventa semplice ed ergonomica da impugnare.
 H 1003 Matteo Thun is an homage to curved volumes. The arched surface of the handle develops in a soft wave that rises and falls, giving movement and three-dimensionality to the handle as well as a simple and ergonomic grip.

Materiale / Material
Ottone / Brass

Maniglia porta / Door handle



Cromosat
Satin chrome



Cromo / Cromosat
Polished chrome / Satin chrome



Anticato
Antique



Orolucido / Orsatin
Polished brass / Satin brass



Orolucido
Polished brass



Orsatin
Satin brass

Coordinati / Matches

Finestra / Window handle

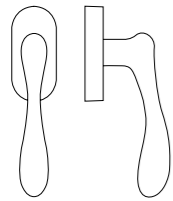

P. 211

In abbinamento sono disponibili / In combination with

Bocchette
Escutcheons
P. 240

Chiusure privacy BZG
Bathroom privacy sets
P. 252



Disponibile su richiesta **Classe 4** secondo la norma EN 1906.
 Upon request, Class 4 is also available according to EN 1906.
 P. 295

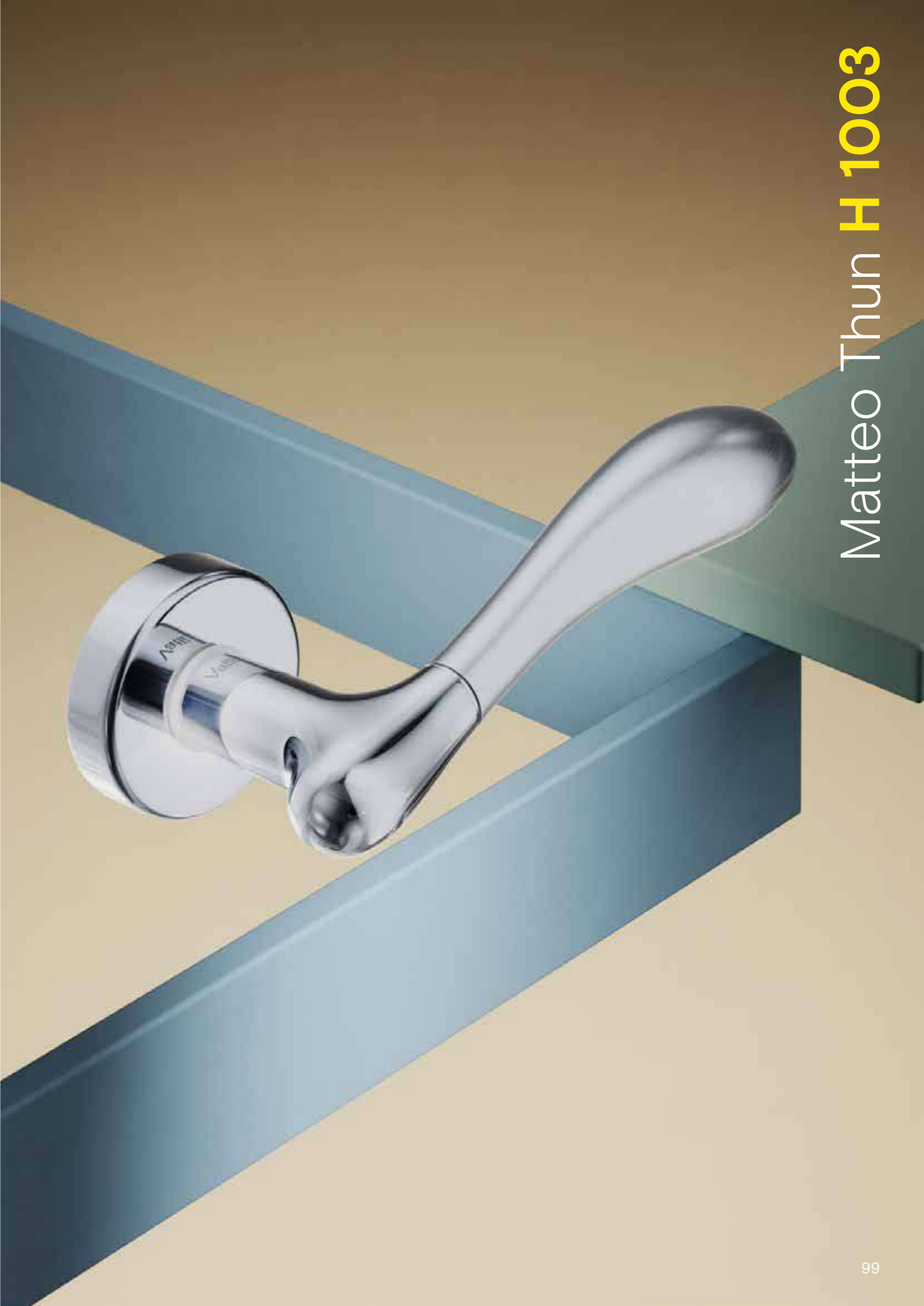

Matteo Thun **H 1003**

H 330 Matteo Thun è una riflessione sull'archetipo della maniglia che ha prodotto una rivisitazione contemporanea della sua forma classica. Il design si sviluppa nel senso della fluidità, attraverso curve e profili arrotondati che danno alla maniglia una scultorea e levigata plasticità. / H 330 Matteo Thun is a contemporary reinterpretation of the classic handle archetype. A fluid design with curves and rounded profiles gives the handle a smooth and sculptural shape.

Materiale / Material

Ottone / BrassCromosat
Satin chrome

Maniglia porta / Door handle



Coordinati / Matches

Finestra / Window handle

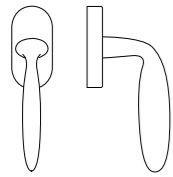

P. 211

In abbinamento sono disponibili / In combination with

Bocchette
Escutcheons
P. 240

Chiusure privacy BZG
Bathroom privacy sets
P. 252



Disponibile su richiesta **Classe 4 secondo la norma EN 1906**.
Upon request, Class 4 is also available according to EN 1906.
P. 295

H 386 Meneghello Paoelli ha un'estetica definita e inconsueta, che si ispira alle opere di Jeff Koons. La maniglia sembra avere una sagoma cava, gonfiata all'interno e pinzata ai bordi come un piccolo imbottito. Ne risulta una forma essenziale, comoda ed ergonomica ma anche molto evocativa. / H 386 Meneghello Paoelli boasts an original and defined aesthetic inspired by the work of Jeff Koons. The handle resembles a hollow shape that has been inflated or stuffed and sealed at the edges. The result is minimal, comfortable, and ergonomic yet also highly expressive.

Materiale / Material

Nikrall Lega Zama UNI 3717

Maniglia porta / Door handle



Cromo
Polished chrome

Cromosat
Satin chrome

Light black
Light black

Nikeinero
Black nickel

Coordinati / Matches

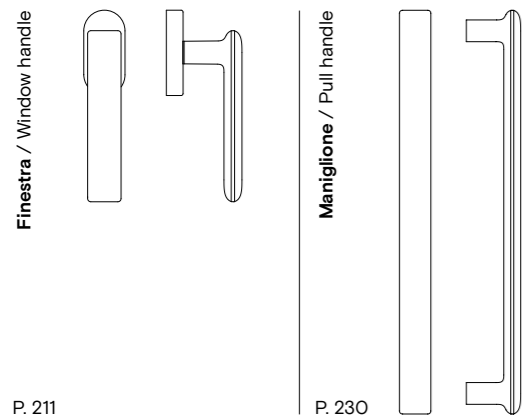

P. 211

P. 230

In abbinamento sono disponibili / In combination with

Bocchette
Escutcheons
P. 240

Chiusure privacy BZG
Bathroom privacy sets
P. 252

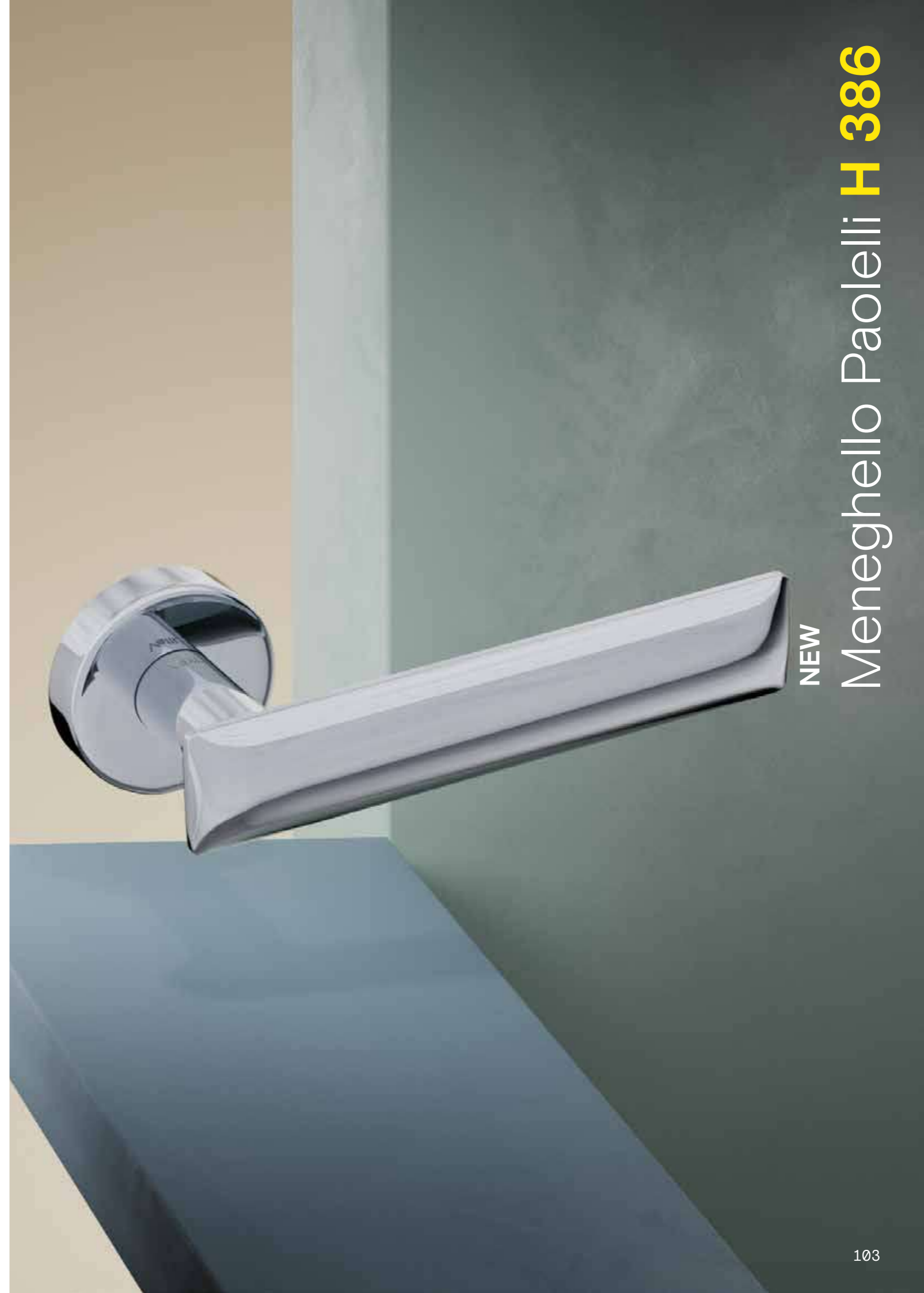

NEW
Meneghello Paoelli **H 386**

H 1052 Mikhail Leykin è una maniglia dal design ultramodernista e aerodinamico. La leva è un'elegante pinna dalla linea filante, che si ispessisce e si rastrema seguendo le direttrici dell'ergonomia, imprimendo un senso di velocità e di flusso all'intera impugnatura.
 H 1052 Mikhail Leykin boasts an ultra-modern and aerodynamic design. The lever is an elegant, streamlined fin that thickens and tapers ergonomically, imparting a sense of speed and flow to the entire handle.

Materiale / Material
Ottone / Brass

Maniglia porta / Door handle



Cromo
 Polished chrome



Cromosat
 Satin chrome



Biancopaco
 Matt white



Bronzop
 Matt bronze



Neropaco
 Matt black

Coordinati / Matches

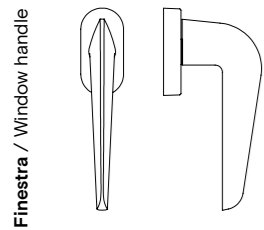

Finestra / Window handle

P. 212

In abbinamento sono disponibili / In combination with

Bocchette
 Escutcheons
 P. 240

Chiusure privacy BZG
 Bathroom privacy sets
 P. 252



Disponibile su richiesta **Classe 4** secondo la norma EN 1906.
 Upon request, Class 4 is also available according to EN 1906.
 P. 295



Mikhail Leykin **H 1052**

H 1068 Pembroke & Ives si ispira ai riflessi argentei e brillanti della luna e si genera a partire da un unico elemento di metallo piegato in due angoli retti. L'impugnatura risulta essenziale, quadrata e regolare, trasmettendo un'immediata sensazione di solidità e di personalità. / H 1068 Pembroke & Ives series was inspired by the silvery glimmers of the moon. It is formed of a single metal element bent into two right angles. A minimal, square grip that immediately transmits solidity and personality.

Materiale / Material

Ottone / Brass

Maniglia porta / Door handle

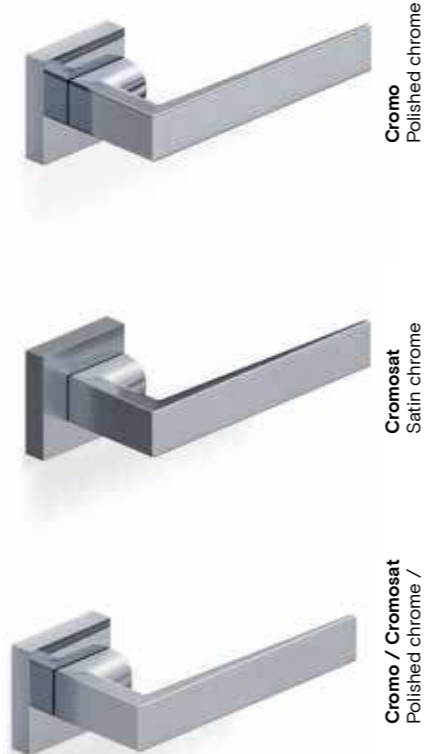
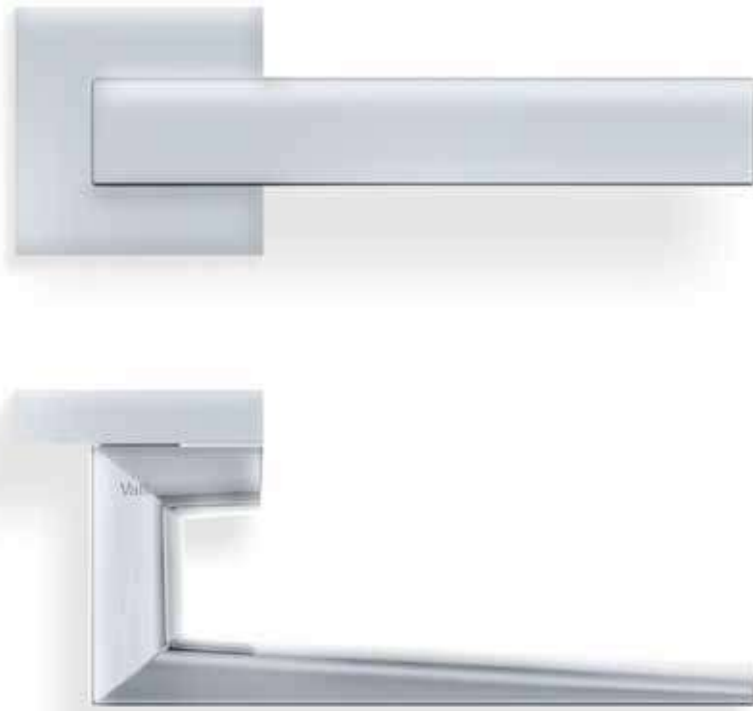

Cromo
Polished chrome

Cromosat
Satin chrome

Cromo / Cromosat
Polished chrome /
Satin chrome

Coordinati / Matches

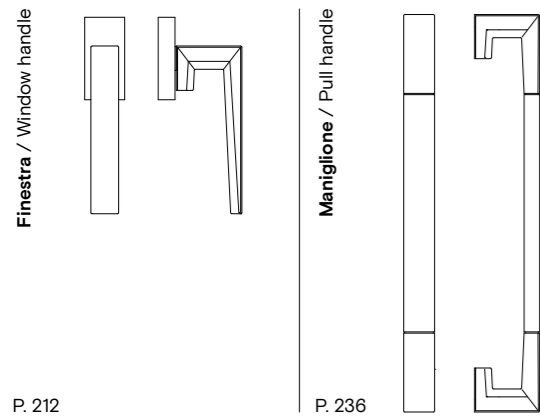

In abbinamento sono disponibili / In combination with

Bocchette
Escutcheons
P. 240

Chiusure privacy BZG
Bathroom privacy sets
P. 252



Disponibile su richiesta **Classe 4** secondo la norma EN 1906.
Upon request, Class 4 is also available according to EN 1906.
P. 295

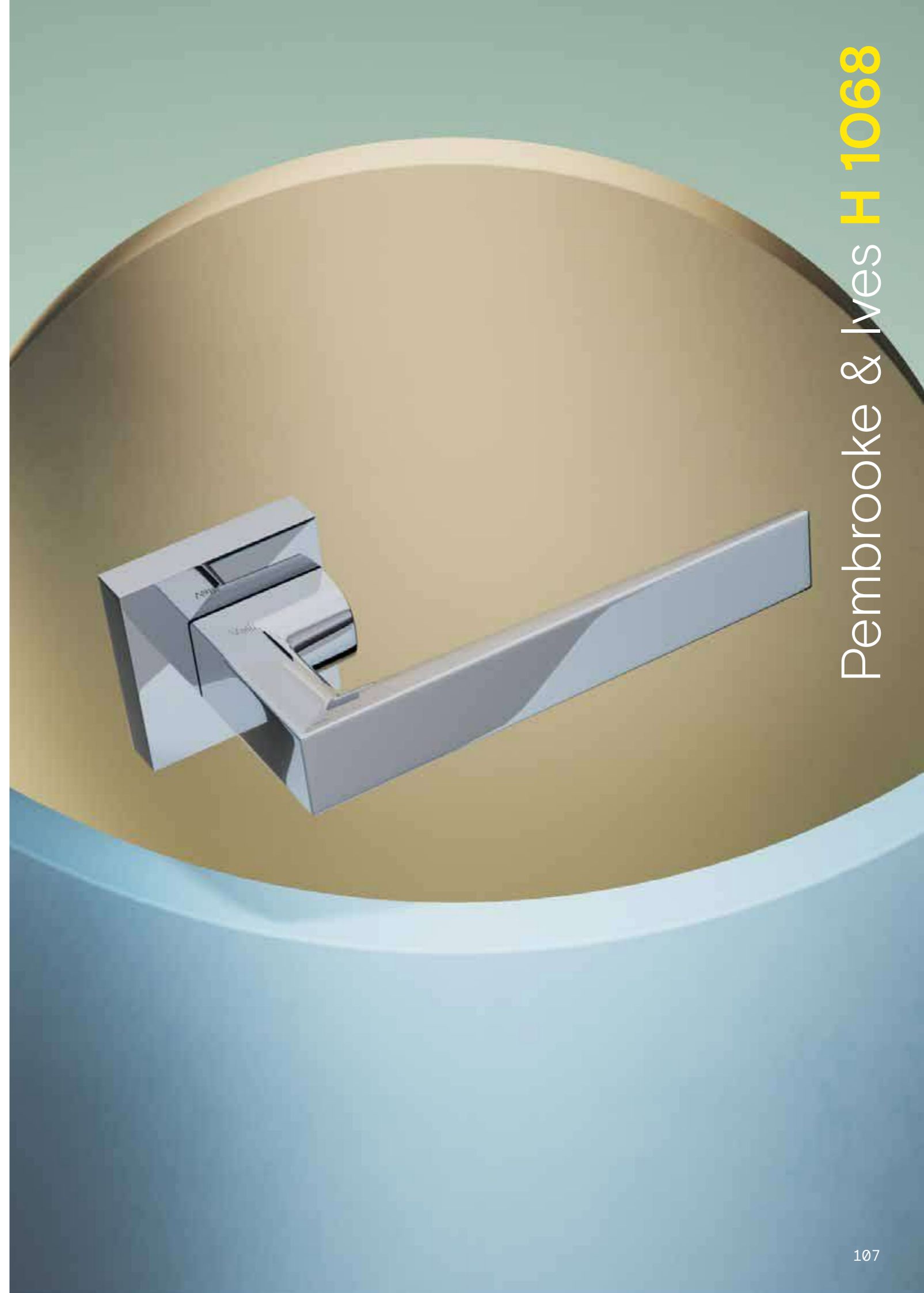

Pembroke & Ives **H 1068**

H 383 Perkins&Will si ispira alla forza espressiva della natura. L'impugnatura si flette e ruota su se stessa con armonia e leggerezza, allungandosi in un'unica linea dal movimento flessuoso e di elegante essenzialità.

H 383 Perkins&Will is inspired by the expressive power of nature. The handle is a single line that flexes and rotates on itself to accompany the hand, resulting in a supple and elegant design.

Materiale / Material

Ottone / Brass

Maniglia porta / Door handle



Cromosat
Satin chrome



Bronzo scuro
Dark bronze



Nikelnero
Black nickel

Coordinati / Matches

Finestra / Window handle

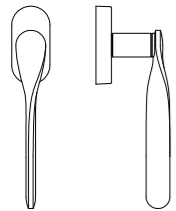

P. 212

Pomolo / Door knob

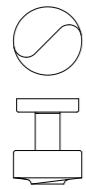

P. 224

Maniglione / Pull handle

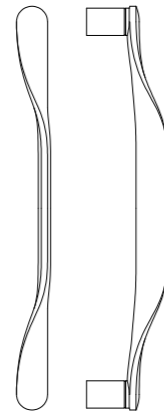

P. 230

In abbinamento sono disponibili / In combination with

Bocchette
Escutcheons
P. 240

Chiusure privacy BZG
Bathroom privacy sets
P. 252



Perkins&Will H 383

H 315 Pierluigi Cerri è una elegantissima maniglia-pomolo con l'impugnatura a forma di ovale schiacciato, più corta di una normale leva da porta e per questo molto semplice e maneggevole da usare. Il rivestimento in porcellana bianca riverbera candore alla vista e piacevolezza al tatto. / H 315 Pierluigi Cerri is an extremely elegant knob with a flattened oval-shaped grip. It is shorter than a normal door handle and therefore very simple and easy to use. The white porcelain coating is pleasing to the eye and the touch.

Materiale / Material

Ottone + Porcellana
Brass + Porcelain



Cromo
Polished chrome



Oro lucido
Polished brass

Maniglia porta / Door handle

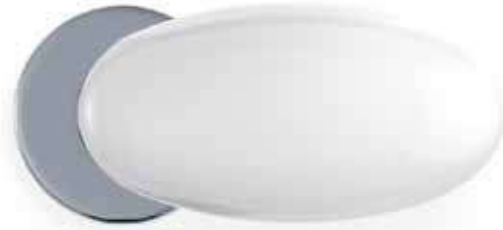

Coordinati / Matches

Finestra / Window handle

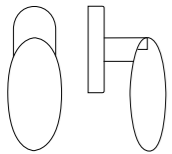

P. 212

In abbinamento sono disponibili / In combination with

Bocchette
Escutcheons
P. 240

Chiusure privacy BZG
Bathroom privacy sets
P. 252



Pierluigi Cerri H 315

H 335 Richard Meier è un elogio dell'estetica postmoderna e del principio combinatorio delle forme. Il concept combina le curve della rosetta e del perno con la linearità della leva dagli spigoli fortemente smussati. Il risultato è una maniglia sofisticata, di grande classe e armonia.
 H 335 Richard Meier is a tribute to postmodern aesthetics and the combinatorial principle of forms. The concept plays on the pairing of the curved rose and spindle with the linearity of a lever with extremely rounded edges. The result is a sophisticated handle that embodies class and harmony.

Materiale / Material

Ottone / Brass



Cromo
Polished chrome

Maniglia porta / Door handle



Coordinati / Matches

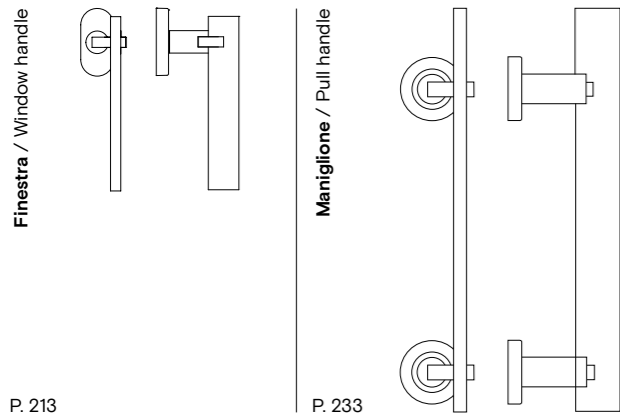

In abbinamento sono disponibili / In combination with

Bocchette
Escutcheons
P. 240

Chiusure privacy BZG
Bathroom privacy sets
P. 252

H 359 Skidmore, Owings & Merrill è disegnata dal prestigioso studio newyorkese. L'impugnatura flessuosa della maniglia è definita da torsioni, restringimenti e modellazioni che la rendono simile a un'elegantissima scultura marmorea.
 H 359 Skidmore, Owings & Merrill was designed by the prestigious New York studio. The supple handle has been twisted, narrowed, and remodelled to resemble an elegant marble sculpture.

Materiale / Material
Ottone / Brass

Maniglia porta / Door handle



Cromo
Polished chrome

Cromosat
Satin chrome

Bronzsat
Bronzsat

Coordinati / Matches

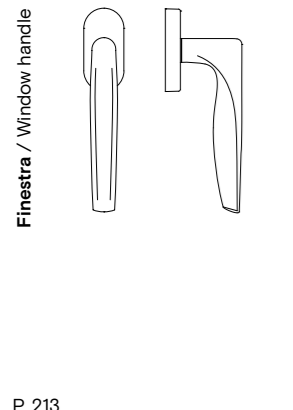

In abbinamento sono disponibili / In combination with

Bocchette
Escutcheons
P. 240

Chiusure privacy BZG
Bathroom privacy sets
P. 252



Disponibile su richiesta **Classe 4** secondo la norma EN 1906.
 Upon request, Class 4 is also available according to EN 1906.
 P. 295



Skidmore, Owings & Merrill **H 359**

H 377 Steve Leung è un omaggio alla cultura cinese e rievoca le chiusure in ottone dei baui tradizionali e gli antichi lucchetti per le porte. La maniglia è formata da un articolato sistema di sottili cilindri che compongono un design minimale ed elegantissimo con accenti retrò.
 H 377 Steve Leung is a tribute to Chinese culture and evokes the brass closures of traditional trunks and ancient padlocks. An articulated system of thin cylinders creates a minimal and extremely elegant design with a slightly retro feel.

Materiale / Material
Ottone / Brass

Maniglia porta / Door handle

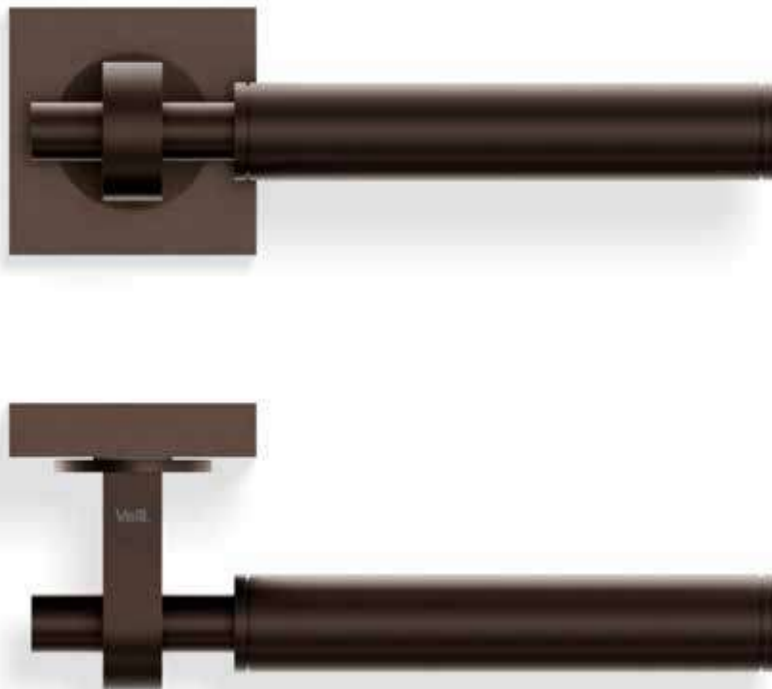

**Bronzo scuro +
 Pelle nera**
 Dark bronze +
 Black leather



Bronzo scuro
 Dark bronze



Neropaco
 Matt black



Nikeinero
 Black nickel



Titanium PVD
 Titanium PVD

Coordinati / Matches

Finestra / Window handle

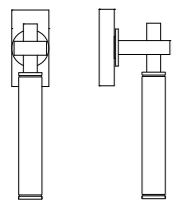

P. 213

Pomolo / Door knob

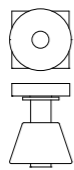

P. 224

Maniglione / Pull handle

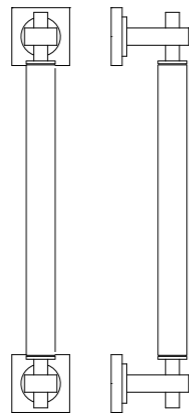

P. 231

In abbinamento sono disponibili / In combination with

Bocchette
 Escutcheons
 P. 240

Chiusure privacy BZG
 Bathroom privacy sets
 P. 252



Steve Leung H 377

H 377 P Steve Leung è un'evoluzione della H 377. Ispirata alle chiusure dei bauli tradizionali cinesi, la maniglia propone un'elegante combinazione di tondi sottili che disegnano un'impugnatura essenziale e raffinata, nobilitata sulla leva dal rivestimento in morbida pelle intrecciata. / The H 377 P Steve Leung is an evolution of the H 377 Steve Leung. Also inspired by traditional Chinese trunk closures, the handle is an elegant combination of cylinders that form a minimal and sophisticated grip, embellished with a soft, woven leather cover.

Materiale / Material

Ottone + Pelle
Brass + Leather



Bronzo scuro +
Pelle marrone
Dark bronze +
Brown leather

Maniglia porta / Door handle



Coordinati / Matches

Finestra / Window handle

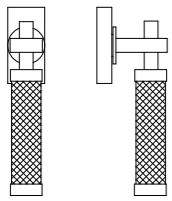

P. 213

Pomolo / Door knob

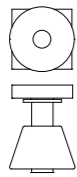

P. 224

Maniglione / Pull handle

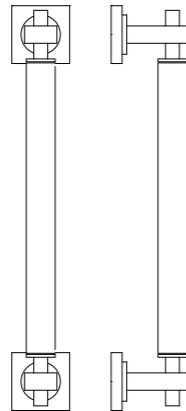

P. 231

In abbinamento sono disponibili / In combination with

Bocchette
Escutcheons
P. 240

Chiusure privacy BZG
Bathroom privacy sets
P. 252

H 329 Taller Design Ricardo Bofill è composta dalla sottile piastra lineare della leva che si innesta perpendicolarmente e longitudinalmente sui due cilindri del perno e dell'impugnatura, generando una maniglia sofisticata dotata di una grazia e un'eleganza non comuni. / H 329 Taller Design Ricardo Bofill is formed of a slender, linear lever that engages perpendicularly and longitudinally with the cylindrical spindle and handle, to generate a complex composition endowed with uncommon grace and elegance.

Materiale / Material
Ottone / Brass

Maniglia porta / Door handle

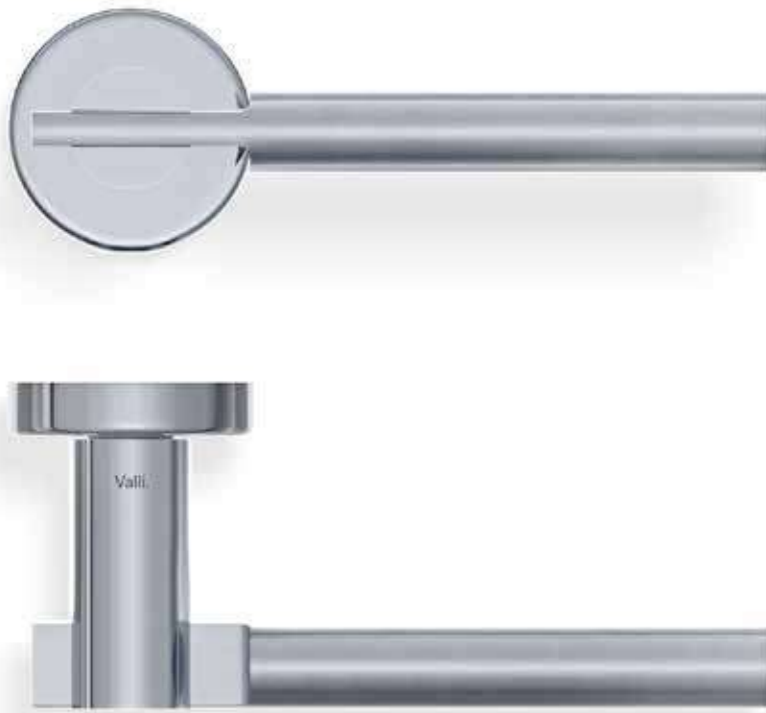

Cromo / Cromosat
Polished chrome /
Satin chrome



Oro lucido / Or satin
Polished brass /
Satin brass

Coordinati / Matches

Finestra / Window handle

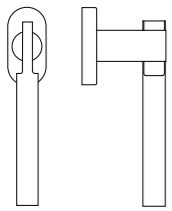

P. 214

Maniglione / Pull handle

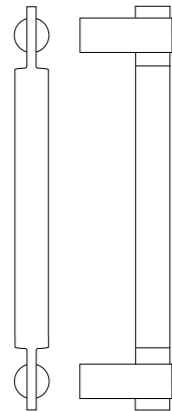

P. 232

In abbinamento sono disponibili / In combination with

Bocchette
Escutcheons
P. 240

Chiusure privacy BZG
Bathroom privacy sets
P. 252



Taller Design Ricardo Bofill H 329

H 5008 Taller Design Ricardo Bofill è una maniglia fatta di volumi puri che si intersecano dando vita a una forma semplice e sofisticata allo stesso tempo. L'impugnatura è formata da un sottile parallelepipedo che diventa, nella parte finale, un cilindro puro, elegante ed ergonomico. / H 5008 Taller Design Ricardo Bofill is made from pure volumes that intersect to form a shape that is both simple and complex. The handle is a thin parallelepiped that transforms into a pure, elegant, and ergonomic cylinder.

Materiale / Material

Acciaio inox AISI 316 L
Stainless steel AISI 316 L



Acciaio inox satinato
Satin stainless steel

Maniglia porta / Door handle

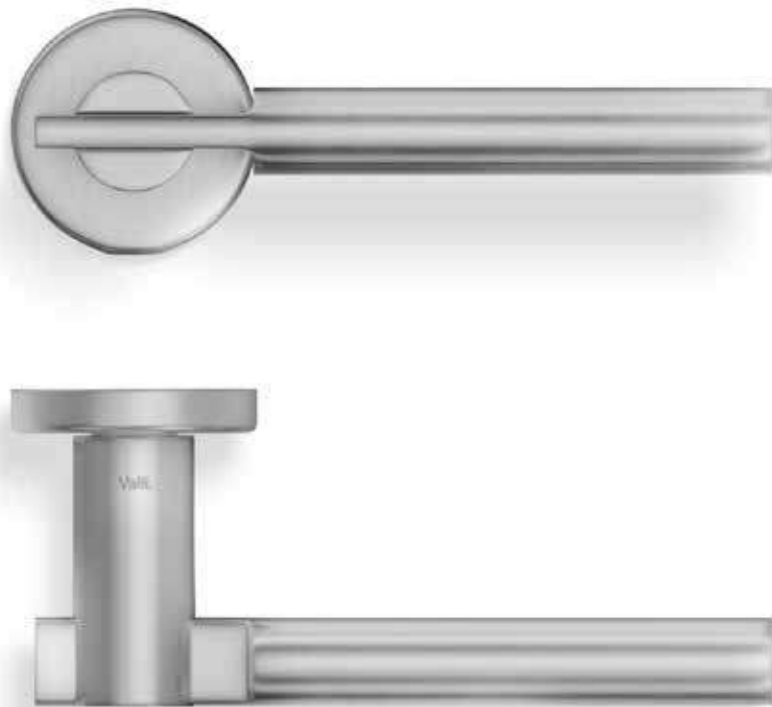

Coordinati / Matches

Finestra / Window handle

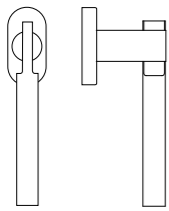

P. 214

Maniglione / Pull handle

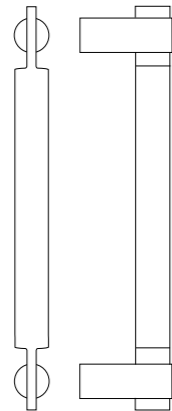

P. 233

In abbinamento sono disponibili / In combination with

Bocchette
Escutcheons
P. 240

Chiusure privacy BZG
Bathroom privacy sets
P. 252

H 1044 Vincent Van Duysen è una maniglia estremamente asciutta, essenziale e lineare. La leva è perfettamente orizzontale, regolare, sottile, dagli spigoli stondanti, innestata su una rosetta tonda. / H 1044 Vincent Van Duysen is a restrained, minimal, and linear handle. The lever is composed of a slim, horizontal, blade with rounded edges, grafted onto a round rose.

Materiale / Material

Nikrall Lega Zama UNI 3717

Maniglia porta / Door handle

**Cromo**
Polished chrome**Cromosat**
Satin chrome**Neropaco**
Matt black

Coordinati / Matches

Finestra / Window handle

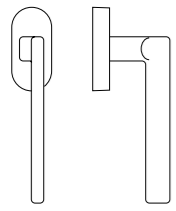

P. 214

In abbinamento sono disponibili / In combination with

Bocchette
Escutcheons
P. 240**Chiusure privacy BZG**
Bathroom privacy sets
P. 252

H 1044 U Vincent Van Duysen è una maniglia estremamente asciutta, essenziale e lineare. La leva è perfettamente orizzontale, regolare, sottile, dagli spigoli stondanti, innestata su una rosetta tonda. Nella versione U l'impugnatura termina con il ritorno della leva su rosetta tonda. / H 1044 U Vincent Van Duysen is a restrained, minimal, and linear handle. The lever is composed of a slim, horizontal, blade with rounded edges, grafted onto a round rose. The U model is hooked with a round rose.

Materiale / Material

Ottone / Brass

Maniglia porta / Door handle

**Cromo**
Polished chrome**Cromosat**
Satin chrome**Neropaco**
Matt blackVincent Van Duysen **H 1044 U**

In abbinamento sono disponibili / In combination with

Bocchette
Escutcheons
P. 240**Chiusure privacy BZG**
Bathroom privacy sets
P. 252

H 1044 Q Vincent Van Duysen è una maniglia estremamente asciutta, essenziale e lineare. La leva è perfettamente orizzontale, regolare, sottile, dagli spigoli stondanti, innestata su una rosetta tonda. Nella versione Q la rosetta è quadrata. / H 1044 Q Vincent Van Duysen is a restrained, minimal, and linear handle. The lever is composed of a slim, horizontal, blade with rounded edges, grafted onto a round rose. The Q model is straight with a square rose.

Materiale / Material

Nikrall Lega Zama UNI 3717**Cromo**
Polished chrome**Cromosat**
Satin chrome**Neropaco**
Matt black

Maniglia porta / Door handle



Coordinati / Matches

Finestra / Window handle

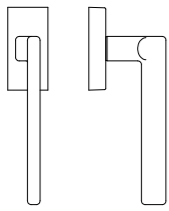

P. 214

In abbinamento sono disponibili / In combination with

Bocchette
Escutcheons
P. 240**Chiusure privacy BZG**
Bathroom privacy sets
P. 252

H 1044 U Q Vincent Van Duysen è una maniglia estremamente asciutta, essenziale e lineare. La leva è perfettamente orizzontale, regolare, sottile, dagli spigoli stondanti, innestata su una rosetta tonda. La versione U Q è a uncino su rosetta quadrata. / H 1044 U Q Vincent Van Duysen is a restrained, minimal, and linear handle. The lever is composed of a slim, horizontal, blade with rounded edges, grafted onto a round rose. The U Q model is hooked with a square rose.

Materiale / Material

Ottone / Brass

Maniglia porta / Door handle

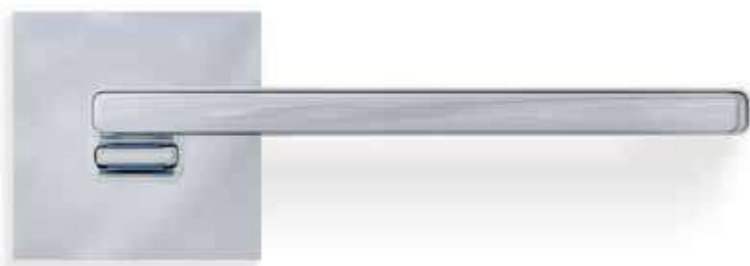
**Cromo**
Polished chrome**Cromosat**
Satin chrome**Neropaco**
Matt black

In abbinamento sono disponibili / In combination with

Bocchette
Escutcheons
P. 240**Chiusure privacy BZG**
Bathroom privacy sets
P. 252

H 378 Yabu Pushelberg è una maniglia che combina la linearità della leva e dell'impugnatura, perfettamente squadrate e orizzontali, alla geometria della forma a stella che si innesta all'altezza della rosetta, aggiungendo un surplus di energia e di dinamismo compositivo all'essenzialità della maniglia. / H 378 Yabu Pushelberg is an ironic play of simple, clean, and elegant shapes. The linear and perfectly horizontal lever is embellished with a geometric star element at the rose end, adding a touch of energy and compositional dynamism to the minimal design.

Materiale / Material
Ottone / Brass

Maniglia porta / Door handle



Cromo
Polished chrome

Bronzo scuro
Dark bronze

Light black
Light black

Coordinati / Matches

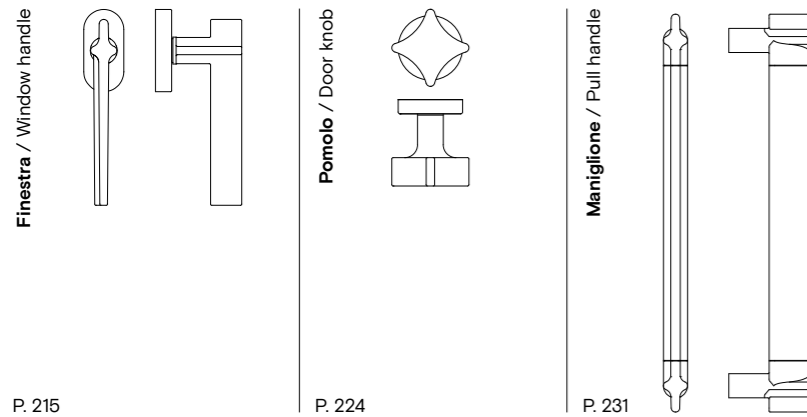

In abbinamento sono disponibili / In combination with

Bocchette
Escutcheons
P. 240

Chiusure privacy BZG
Bathroom privacy sets
P. 252



Disponibile su richiesta **Classe 4** secondo la norma EN 1906.
Upon request, Class 4 is also available according to EN 1906.
P. 295



Yabu Pushelberg **H 378**

H 338 Yoshimi Kono è una maniglia scultorea e originale, che si ispira al movimento delle onde del mare. L'impugnatura si curva verso l'alto e si assottiglia in una morbida ed elegante onda che accompagna il movimento della mano.

H 338 Yoshimi Kono is an original, sculptural handle inspired by the movement of the sea. The handle curves upwards and tapers into a soft and elegant wave that accompanies the movement of the hand.

Materiale / Material

Ottone / Brass



Cromosat
Satin chrome

Maniglia porta / Door handle



Coordinati / Matches

Finestra / Window handle

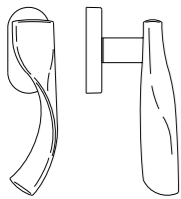

P. 215

In abbinamento sono disponibili / In combination with

Bocchette
Escutcheons
P. 240

Chiusure privacy BZG
Bathroom privacy sets
P. 252



Disponibile su richiesta **Classe 4** secondo la norma EN 1906.
Upon request, Class 4 is also available according to EN 1906.
P. 295

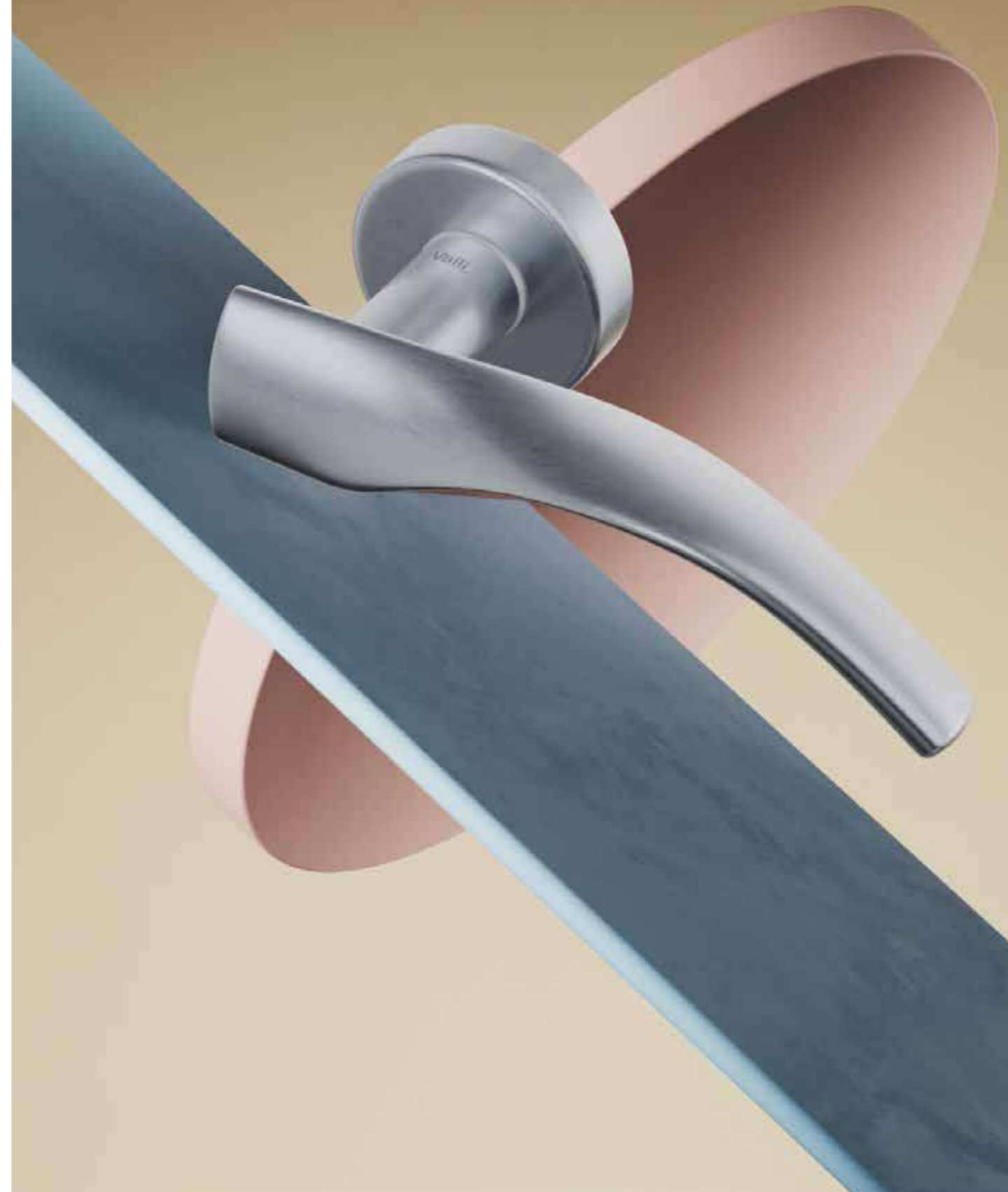

H 1045 Yoshimi Kono è una riflessione sui concetti di stabilità e concretezza a partire da volumi puri ed essenziali. La base solida e regolare del perno si assottiglia e si allunga senza soluzione di continuità trasformandosi in una leva costituita da un'impugnatura sottile e rettilinea. / H 1045 Yoshimi Kono is a pure and minimal handle that reflects on the concept of stability. The solid and regular base of the spindle tapers and lengthens uninterruptedly into a thin and rectilinear lever.

Materiale / Material

Nikrall Lega Zama UNI 3717

Maniglia porta / Door handle



Cromo
Polished chrome



Cromosat
Satin chrome



Cromo / Cromosat
Polished chrome /
Satin chrome



Nikeinero
Black nickel

Coordinati / Matches

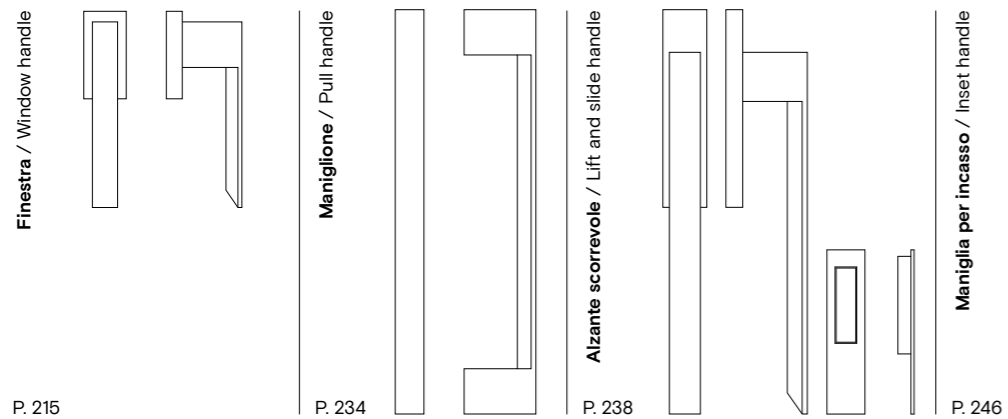

In abbinamento sono disponibili / In combination with

Bocchette
Escutcheons
P. 240

Chiusure privacy BZG
Bathroom privacy sets
P. 252



Disponibile su richiesta **Classe 4** secondo la norma EN 1906.
Upon request, Class 4 is also available according to EN 1906.
P. 295

H 356 Zaha Hadid nasce da uno straordinario e avveniristico concept di progetto. Il profilo a linee spezzate è una scultura futuristica modellata attraverso la torsione ascendente di volumi spigolosi, con rientranze e sporgenze che offrono un'insospettabile ergonomia all'impugnatura. / H 356 Zaha Hadid was inspired by an extraordinary, futuristic design concept. The profile with broken lines is a futuristic sculpture with a twisted angular shape. The recesses and protrusions created offer unexpected ergonomics.

Materiale / Material

Nikrall Lega Zama UNI 3717

Cromo
Polished chrome

Cromosat
Satin chrome

Maniglia porta / Door handle

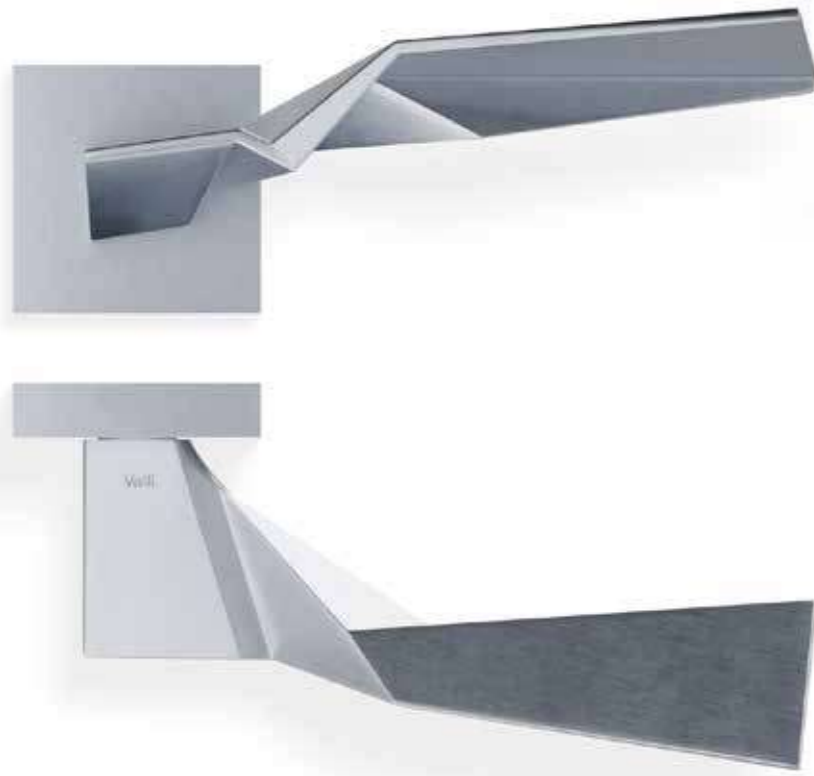

Coordinati / Matches

Finestra / Window handle

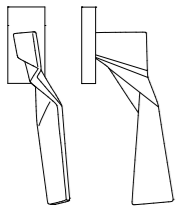

P. 215

In abbinamento sono disponibili / In combination with

Bocchette
Escutcheons
P. 240

Chiusure privacy BZG
Bathroom privacy sets
P. 252



Collezione / Collection

Lab



H 1058 Amica è una rivisitazione in chiave moderna dell'archetipo tradizionale e classico della maniglia da porta. La forma, semplice e accogliente per la presa della mano, la rende una maniglia garbata e senza tempo, adatta a ogni contesto e stile. / H 1058 Amica is a contemporary revisitation of the traditional door handle archetype. Its simple curves greet the hand and its graceful, timeless shape makes it suitable for any style and context.

Materiale / Material

Nikrall Lega Zama UNI 3717

Maniglia porta / Door handle

Cromo / Cromosat
Polished chrome
Satin chromeBiancopaco
Matt whiteNikelnero
Black nickel

Coordinati / Matches

Finestra / Window handle

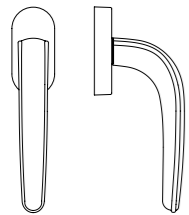

P. 216

In abbinamento sono disponibili / In combination with

Bocchette
Escutcheons
P. 240Chiusure privacy BZG
Bathroom privacy sets
P. 252

Amica H 1058

H 1004 Antares è un omaggio formale all'eleganza classica delle maniglie del passato. Uno stile d'altri tempi che ben si adatta anche ad ambienti moderni con un tocco retrò.

H 1004 Antares is a formal tribute to the classic elegance of traditional handles. An old-fashioned style that is well suited to modern environments with a retro touch.

Materiale / Material

Ottone / Brass

Ottone + Porcellana

Brass + Porcelain

Maniglia porta / Door handle



Brunito / Avorio
Burnished / Ivory



Brunito
Burnished



Oro lucido
Polished brass



Ottone naturale
Natural brass

Coordinati / Matches

Finestra / Window handle

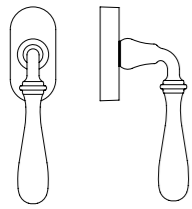

P. 216

In abbinamento sono disponibili / In combination with

Bocchette
Escutcheons
P. 240

Chiusure privacy BZG
Bathroom privacy sets
P. 252



Antares H 1004

H 1062 Carmen si presenta con una linea affilata e sottile. L'essenzialità e la semplicità della sua sagoma nascondono un'ergonomia perfettamente studiata per facilitare e rendere confortevole l'impugnatura. / H 1062 Carmen has sharp lines and a simple minimal shape that hides advanced ergonomics designed to facilitate a comfortable grip.

Materiale / Material
Ottone / Brass

Maniglia porta / Door handle



Cromosat
Satin chrome



Bronzop
Matt bronze



Neropaco
Matt black



Nikeinero
Black nickel

Coordinati / Matches

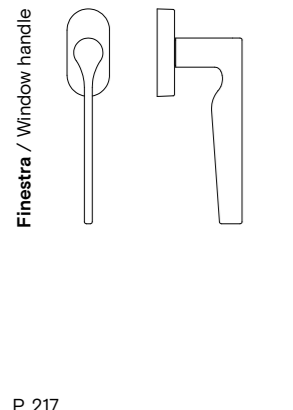

In abbinamento sono disponibili / In combination with

Bocchette
Escutcheons
P. 240

Chiusure privacy BZG
Bathroom privacy sets
P. 252



Carmen H 1062

H 1027 Dafne si presenta con un design minimale ed essenziale, che combina le forme morbide dell'impugnatura cilindrica insieme al taglio secco e lineare della lama di congiunzione della leva con il perno, definendo un insieme elegante, solido e armonioso. / H 1027 Dafne boasts a minimal design that combines a soft cylindrical grip with the clean linear cut of the lever, creating a solid and harmonious whole.

Materiale / Material
Ottone / Brass



Cromosat
Satin chrome



Oro lucido
Polished brass

Maniglia porta / Door handle



Coordinati / Matches

Finestra / Window handle

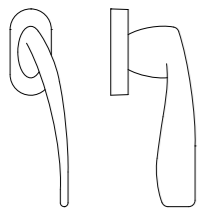

P. 217

In abbinamento sono disponibili / In combination with

Bocchette
Escutcheons
P. 240

Chiusure privacy BZG
Bathroom privacy sets
P. 252



Disponibile su richiesta **Classe 4** secondo la norma EN 1906.
Upon request, Class 4 is also available according to EN 1906.
P. 295

H 1049 Divara è una maniglia che enfatizza l'idea dei volumi regolari proponendosi con una forma salda e squadrata, dagli spigoli leggermente arrotondati per acquisire grazia e morbidezza mantenendo un'eleganza essenziale. / H 1049 Divara emphasises the idea of regular volumes with its powerful squared shape. Slightly rounded edges add grace and softness while maintaining a minimal elegance.

Materiale / Material
Ottone / Brass

Maniglia porta / Door handle

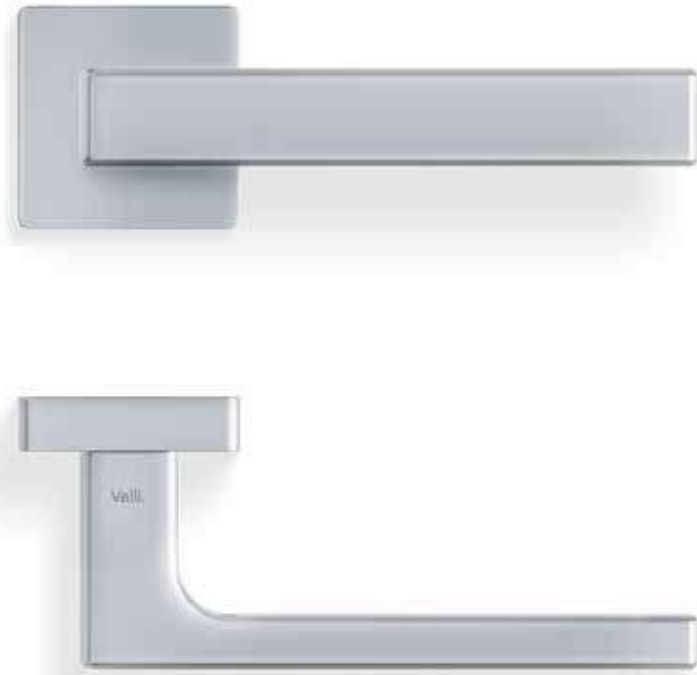

Cromo
Polished chrome



Cromosat
Satin chrome



Light black
Light black



Neropaco
Matt black

Coordinati / Matches

Finestra / Window handle

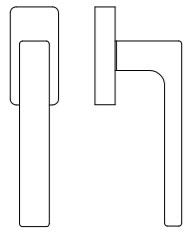

P. 217

In abbinamento sono disponibili / In combination with

Bocchette
Escutcheons
P. 240

Chiusure privacy BZG
Bathroom privacy sets
P. 252



Disponibile su richiesta **Classe 4** secondo la norma EN 1906.
Upon request, Class 4 is also available according to EN 1906.
P. 295

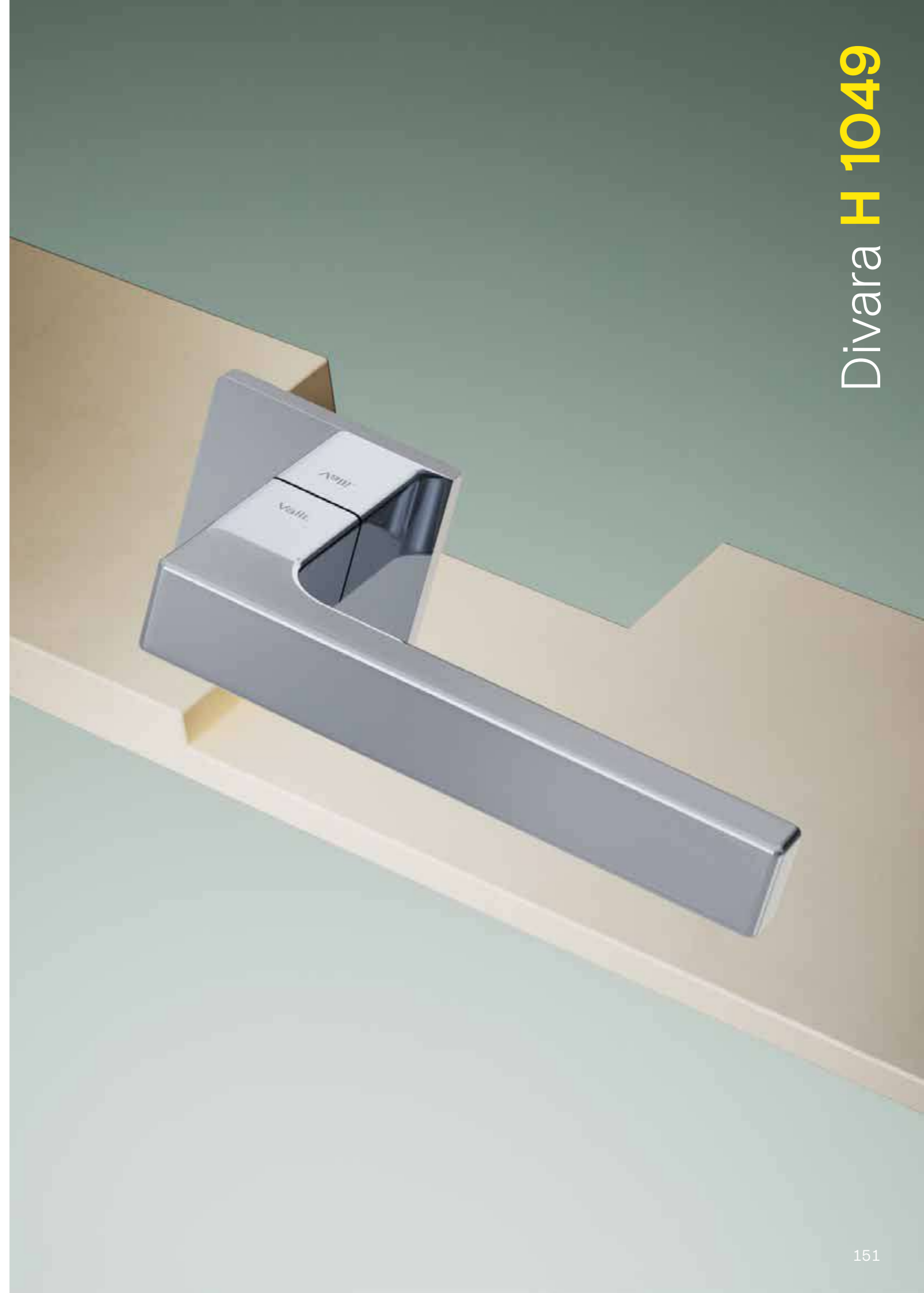

H 1049 T Divara è sorella della H 1049, dalla quale si distingue per la rosetta rotonda anziché quadrata. Questo dettaglio, apparentemente secondario, introduce un elemento curvilineo che accentua la fluidità e il garbo della maniglia. / H 1049 T Divara is from the same family as H 1049 Divara but is set on a round rose instead of square. This seemingly secondary detail introduces a curvilinear element that recalibrates the linear equilibrium of the original, accentuating the fluidity and grace of the handle.

Materiale / Material
Ottone / Brass

Maniglia porta / Door handle



Cromo
Polished chrome



Cromosat
Satin chrome



Light black
Light black



Neropaco
Matt black

Coordinati / Matches

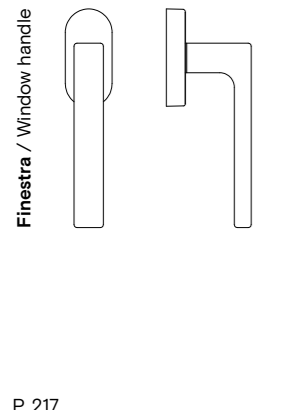

P. 217

In abbinamento sono disponibili / In combination with

Bocchette
Escutcheons
P. 240

Chiusure privacy BZG
Bathroom privacy sets
P. 252



Disponibile su richiesta **Classe 4 secondo la norma EN 1906.**
Upon request, Class 4 is also available according to EN 1906.
P. 295

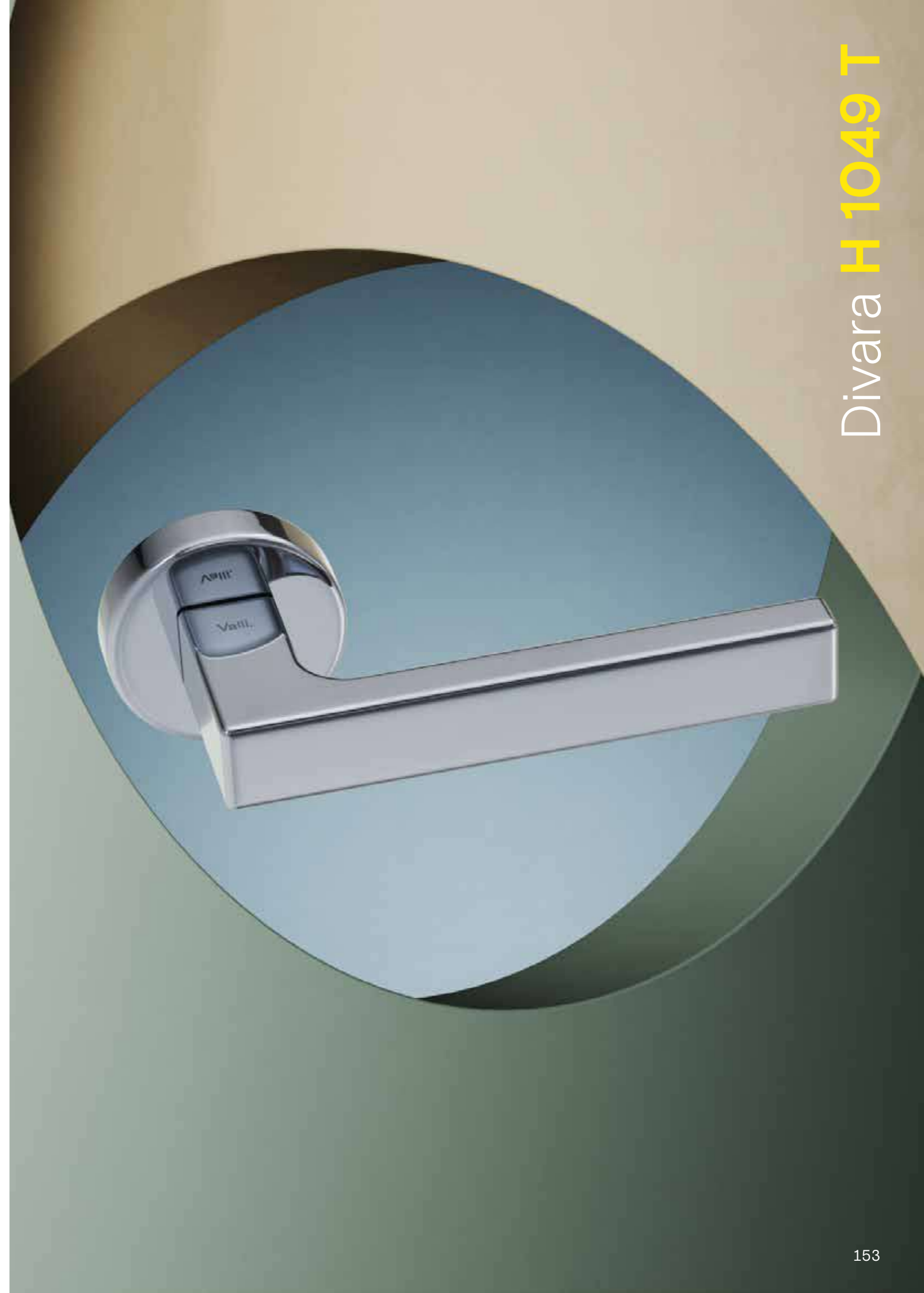

H 1022 Ernani è stata progettata con un'attenzione particolare all'ergonomia e al comfort nel movimento di apertura della porta. La sagoma squadrata all'altezza del perno si ammorbidisce e diventa affusolata e morbida, rendendo H 1022 Ernani una maniglia di grande classe. / H 1022 Ernani was designed with particular attention to ergonomics and comfort. The square base softens into a gentle taper, endowing the H 1022 Ernani with extreme class.

Materiale / Material

Ottone / Brass



Cromo / Cromosat
Polished chrome /
Satin chrome



Oro lucido / Or satin
Polished brass /
Satin brass

Maniglia porta / Door handle

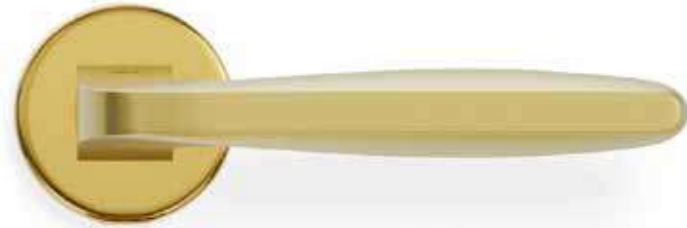

Coordinati / Matches

Finestra / Window handle

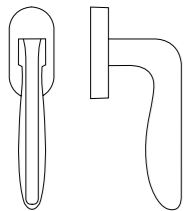

P. 218

In abbinamento sono disponibili / In combination with

Bocchette
Escutcheons
P. 240

Chiusure privacy BZG
Bathroom privacy sets
P. 252



Disponibile su richiesta **Classe 4** secondo la norma EN 1906.
Upon request, Class 4 is also available according to EN 1906.
P. 295



Ernani **H 1022**

H 165 Germana è una maniglia dal gusto classico, generata da un'onda sinuosa e gentile che accompagna in maniera impeccabile il gesto della mano nell'apertura della porta.
 H 165 Germana is both classic and modern, thanks to a soft and sinuous wave that perfectly receives the hand.

Materiale / Material
Ottone / Brass

Maniglia porta / Door handle



Anticato
Antique



Oro lucido
Polished brass



Orsatin
Satin brass

Coordinati / Matches

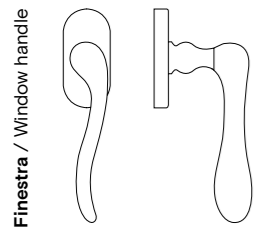

Finestra / Window handle

P. 218

In abbinamento sono disponibili / In combination with

Bocchette
Escutcheons
P. 240

Chiusure privacy BZG
Bathroom privacy sets
P. 252



Disponibile su richiesta **Classe 4** secondo la norma EN 1906.
 Upon request, Class 4 is also available according to EN 1906.
 P. 295

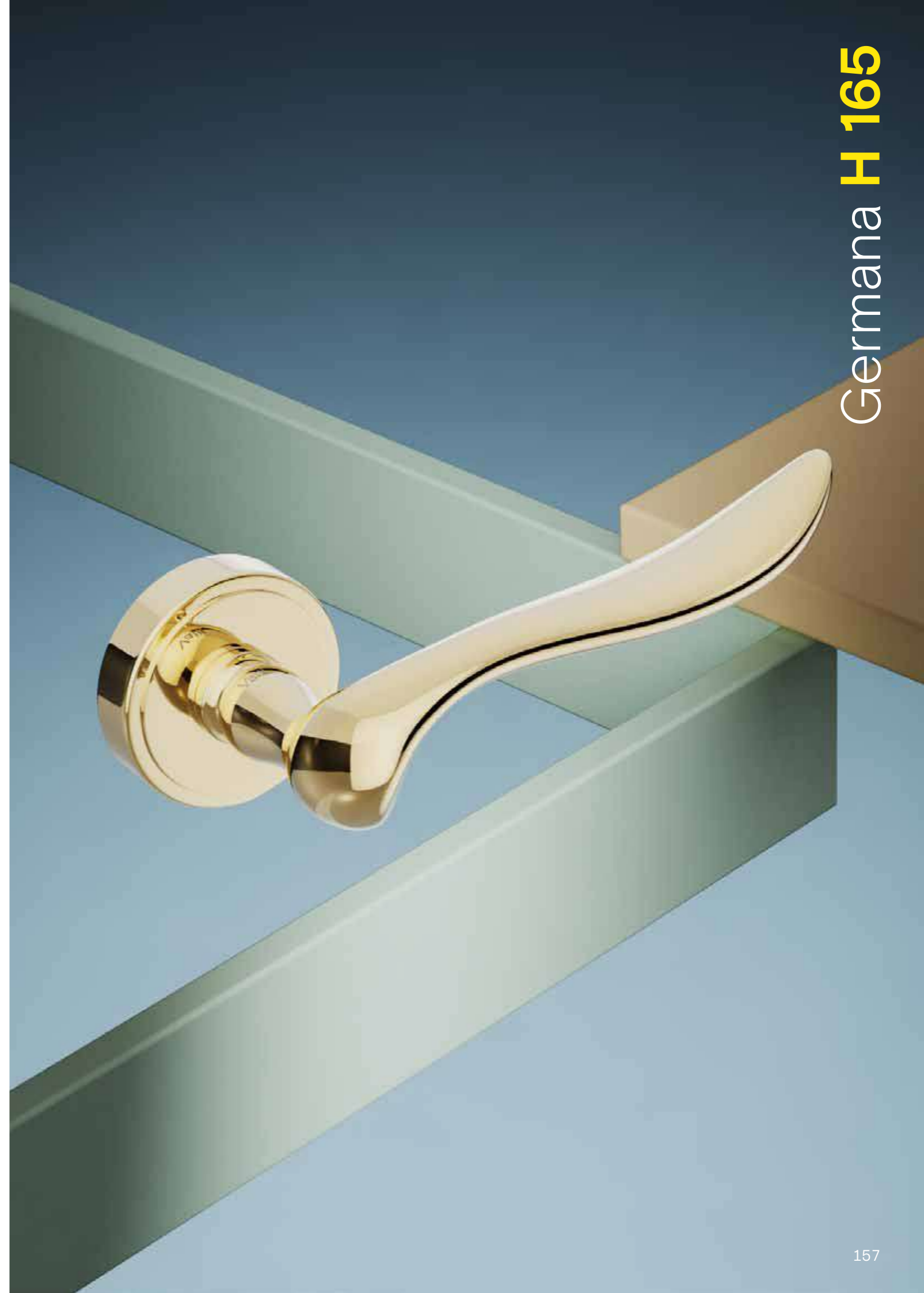

H 1050 Giasone è una maniglia dal design contemporaneo, metropolitano e di grande personalità. Le forme squadrate della leva, perfettamente piatte e sottilissime, sono ingentilite da angoli arrotondati che conferiscono un surplus di complessità e di classe alla maniglia. / H 1050 Giasone boasts a contemporary, metropolitan design and great personality. The square shape of the lever, which is very thin and perfectly flat, is softened by rounded corners that give the handle an extra touch of class and complexity.

Materiale / Material

Ottone / Brass

Maniglia porta / Door handle

**Cromo**
Polished chrome**Cromosat**
Satin chrome**Orsatin**
Satin brass

Coordinati / Matches

Finestra / Window handle

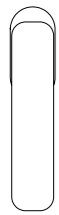

P. 218

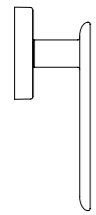

Pomolo / Door knob

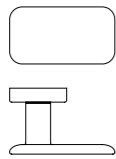

P. 226

In abbinamento sono disponibili / In combination with

Bocchette
Escutcheons
P. 240**Chiusure privacy BZG**
Bathroom privacy sets
P. 252**Disponibile su richiesta Classe 4 secondo la norma EN 1906.**
Upon request, Class 4 is also available according to EN 1906.
P. 295

H 1024 Lolita è una maniglia di grande essenzialità e classe, che si caratterizza per lo spessore della leva e per linee che si addolciscono in curve sugli spigoli e agli angoli. / H 1024 Lolita is a classy, minimal handle, characterised by the thickness of the lever and lines that soften into curves at the edges and corners.

Materiale / Material
Ottone / Brass

Maniglia porta / Door handle



Cromo
Polished chrome



Cromosat
Satin chrome



Oro lucido
Polished brass

Coordinati / Matches

Finestra / Window handle

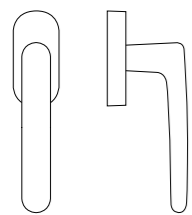

P. 219

In abbinamento sono disponibili / In combination with

Bocchette
Escutcheons
P. 240

Chiusure privacy BZG
Bathroom privacy sets
P. 252



Disponibile su richiesta **Classe 4** secondo la norma EN 1906.
Upon request, Class 4 is also available according to EN 1906.
P. 295



Lolita H 1024

H 123 Luigi XVI è una maniglia ricca e sfarzosa, ispirata alle opulente decorazioni barocche dei palazzi settecenteschi. La solida leva geometrica è impreziosita da borchiette, punzonature e rilievi che punteggiano i bordi del profilo continuando anche sulla rosetta.
 Inspired by the opulent Baroque style of eighteenth-century palaces, H 123 Luigi XVI is a rich and lavish handle that cannot fail to catch the eye. The solid geometric lever is embellished with studs, stamped patterning, and reliefs that continue onto the rose.

Materiale / Material
Ottone / Brass

Maniglia porta / Door handle



Ottone antico
 Antique brass



Oro lucido
 Polished brass

Coordinati / Matches

Finestra / Window handle

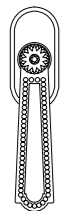

P. 219

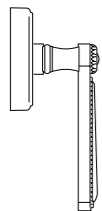

Pomolo / Door knob

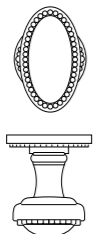

P. 229

In abbinamento sono disponibili / In combination with

Bocchette
 Escutcheons
 P. 240



H 1016 Nabucco è una maniglia in ottone dal design flessuoso e arcuato, che gioca con linee ondulate e volumi sfaccettati abbracciando un'idea di movimento e di torsione attraverso cui l'impugnatura si plasma in una forma elegante, agevolando la presa nel movimento di apertura.
 The supple, arched design of H 1016 Nabucco plays with wavy lines and faceted volumes to create movement and torsion, resulting in an elegant shape that facilitates grip.

Materiale / Material
Ottone / Brass

Maniglia porta / Door handle



Cromosat
Satin chrome



Anticato
Antique



Orolucido
Polished brass

Coordinati / Matches

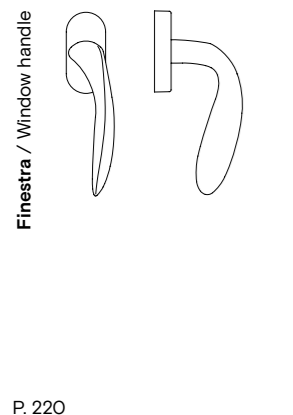

In abbinamento sono disponibili / In combination with

Bocchette
Escutcheons
P. 240

Chiusure privacy BZG
Bathroom privacy sets
P. 252



Disponibile su richiesta **Classe 4** secondo la norma EN 1906.
 Upon request, Class 4 is also available according to EN 1906.
 P. 295



H 1046 Nais è una maniglia essenziale, geometrica e lineare. La forma della leva è perfettamente rettilinea, ma lo spessore smussato ne ammorbidisce il profilo, raffina lo stile e rende l'impugnatura confortevole ed ergonomica alla presa. / H 1046 Nais is a minimal, geometric handle. The lever is straight but its rounded thickness softens and refines the overall style, making the handle comfortable and ergonomic to grip.

Materiale / Material
Ottone / Brass

Maniglia porta / Door handle



Cromo
Polished chrome



Cromosat
Satin chrome



Neropaco
Matt black

Coordinati / Matches

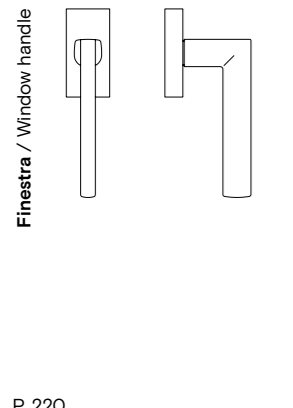

P. 220

In abbinamento sono disponibili / In combination with

Bocchette
Escutcheons
P. 240

Chiusure privacy BZG
Bathroom privacy sets
P. 252



Disponibile su richiesta **Classe 4** secondo la norma EN 1906.
Upon request, Class 4 is also available according to EN 1906.
P. 295



Nais H 1046

H 1046 T Nais unisce l'essenzialità delle linee dritte alla fluidità delle superfici curve che si collegano alla rosetta tonda, differenziandola dalla gemella H 1046 Nais. / H 1046 T Nais blends minimal straight lines with fluid curved surfaces that connect to the round rose, which differentiates this handle from H 1046 Nais.

Materiale / Material
Ottone / Brass

Maniglia porta / Door handle



Cromo
Polished chrome



Cromosat
Satin chrome



Neropaco
Matt black

Coordinati / Matches

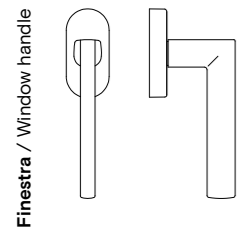

P. 220

In abbinamento sono disponibili / In combination with

Bocchette
Escutcheons
P. 240

Chiusure privacy BZG
Bathroom privacy sets
P. 252



Disponibile su richiesta **Classe 4** secondo la norma EN 1906.
Upon request, Class 4 is also available according to EN 1906.
P. 295



Nais H 1046 T

H 1064 Naked si presenta con un design e una struttura astratte e ridotte all'essenziale, come grado zero dell'idea di maniglia. Lo stile della leva, costituita da un cilindro di metallo regolare ed esile, intercettato dal perno rettangolare sulla rosetta circolare, è di un'eleganza asciutta e delicata. / The abstract design and structure of H 1064 Naked have been reduced to the very minimum. The slender cylindrical metal lever, connected to the round rose by a rectangular base, is restrained and delicate in its elegance.

Materiale / Material

Acciaio C40 / Steel C40

Maniglia porta / Door handle

**Cromosat**
Satin chrome**Biancopaco**
Matt white**Neropaco**
Matt black

Coordinati / Matches

Finestra / Window handle

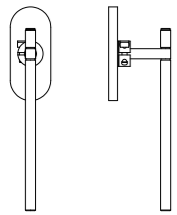

P. 220

In abbinamento sono disponibili / In combination with

Bocchette
Escutcheons
P. 240**Chiusure privacy BZG**
Bathroom privacy sets
P. 252

H 1065 Naked Due ha un design minimalista che esalta la struttura essenziale della maniglia. La leva ha un'impugnatura corposa e regolare, stondata sugli spigoli e intercettata dal volume del perno. Il risultato è una forma pulita ed elegante nella sua semplicità.

The minimalist design of H 1065 Naked Due enhances the simple structure of the handle. Thicker than the original, the lever is rounded at the edges and interrupted at the base. The resulting shape is clean and elegant in its simplicity.

Materiale / Material

Acciaio C40 + Ottone
Steel C40 + Brass

Maniglia porta / Door handle



Cromo
Polished chrome



Cromosat
Satin chrome



Nikelnero
Black nickel

Coordinati / Matches

Finestra / Window handle

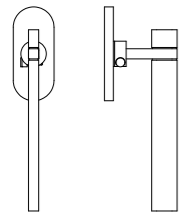

P. 221

In abbinamento sono disponibili / In combination with

Bocchette
Escutcheons
P. 240

Chiusure privacy BZG
Bathroom privacy sets
P. 252

H 192 Prunus è una maniglia semplice, gentile, efficace. La linea della leva è regolare e orizzontale, lo spessore corposo dell'impugnatura è arrotondato e affusolato per creare volumi morbidi e armoniosi, che invitano alla presa offrendo un'eccellente ergonomia.
 H 192 Prunus is a simple and effective handle. The thick horizontal lever is rounded and tapered to create a soft harmonious shape that is both inviting and comfortable to grip.

Materiale / Material

Ottone / BrassNikmatt
Nikmatt

Maniglia porta / Door handle



Coordinati / Matches

Finestra / Window handle

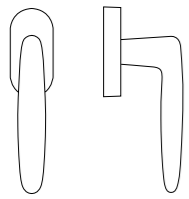

P. 221

In abbinamento sono disponibili / In combination with

Bocchette
Escutcheons
P. 240

Chiusure privacy BZG
Bathroom privacy sets
P. 252



Disponibile su richiesta **Classe 4** secondo la norma EN 1906.
Upon request, Class 4 is also available according to EN 1906.
P. 295

H 1056 Quadra è una maniglia dalle forti componenti geometriche. La forma perfettamente squadrata e regolare dell'impugnatura è ingentilita dalla decorazione geometrica della leva che mette in risalto le ombre contribuendo ad accentuare l'eleganza dei profili. / H 1056 Quadra is composed of geometric components. The perfectly squared handle is softened by an additional decorative layer that creates depth and accentuates the overall elegance of the handle.

Materiale / Material

Nikrall Lega Zama UNI 3717



Cromo
Polished chrome



Neropaco
Matt black



Nikelnero
Black nickel

Maniglia porta / Door handle

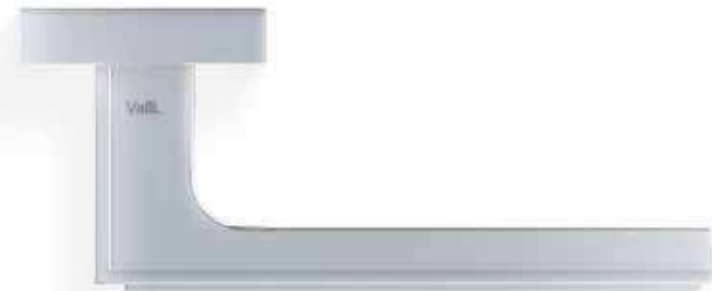
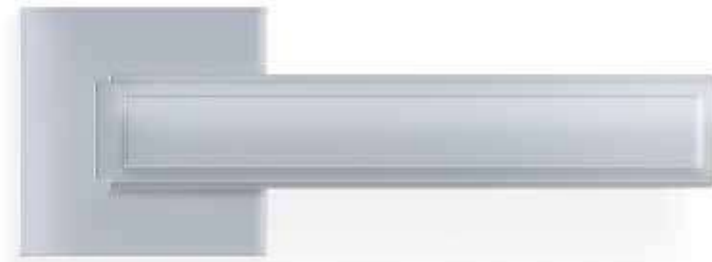

Coordinati / Matches

Finestra / Window handle

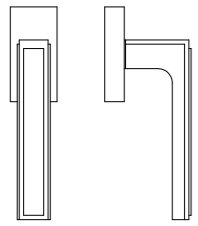

P. 221

Pomolo / Door knob

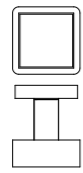

P. 228

Maniglione / Pull handle

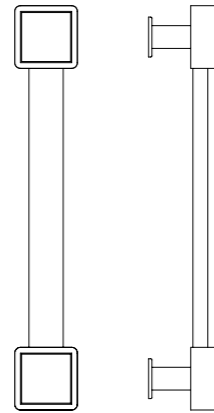

P. 236

In abbinamento sono disponibili / In combination with

Bocchette
Escutcheons
P. 240

Chiusure privacy BZG
Bathroom privacy sets
P. 252

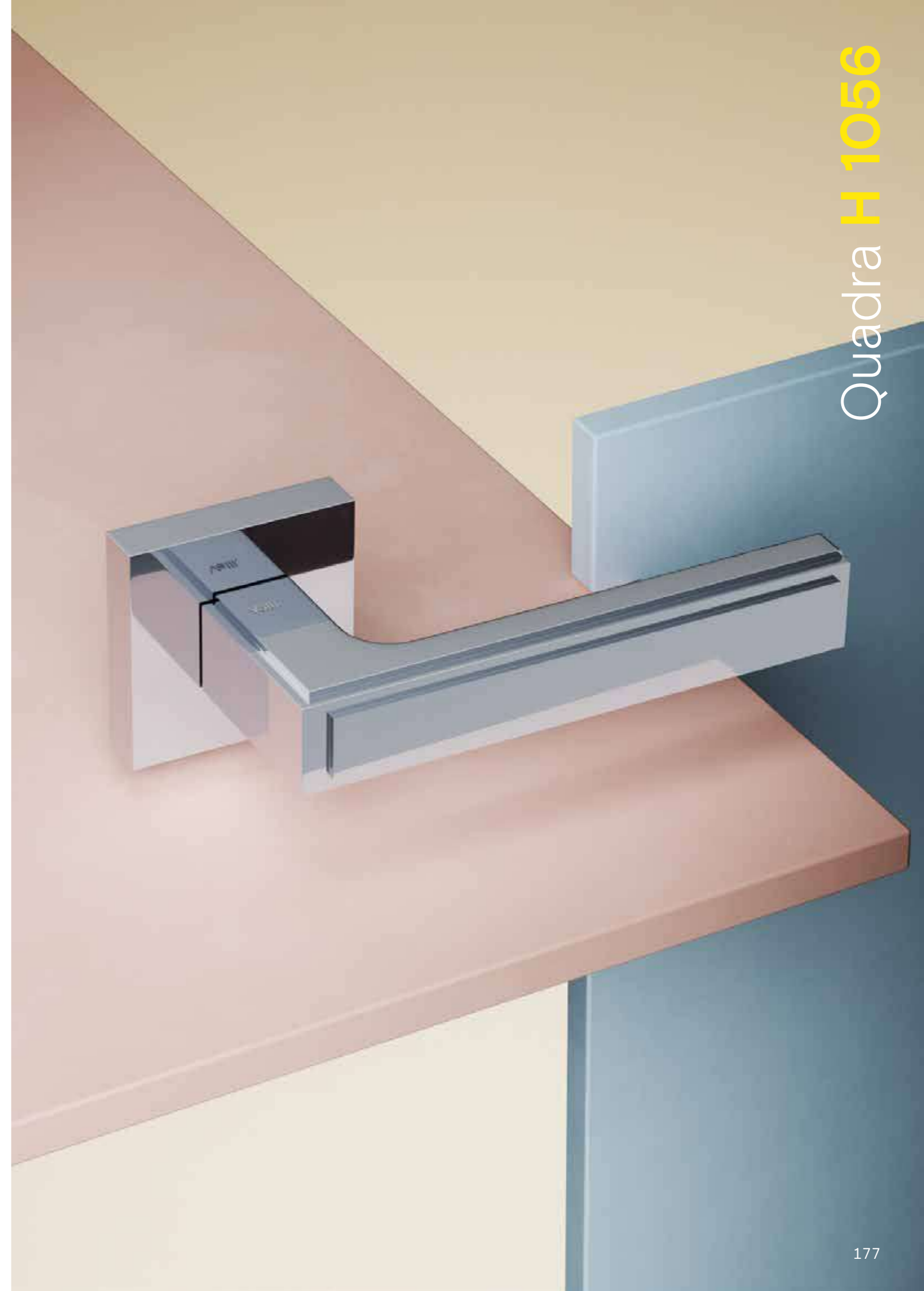

Quadra H 1056

H 1056 T Quadra è una maniglia dalle forti componenti geometriche. La forma perfettamente squadrata e regolare dell'impugnatura è ingentilita dalla decorazione geometrica della leva che si contrappunta con la rosetta rotonda, che la differenzia dalla gemella H 1056 Quadra.

H 1056 Quadra is composed of geometric components. The perfectly squared handle, softened by an additional decorative layer, contrasts with the round rose which differentiates this handle from H 1056 Quadra.

Materiale / Material

Nikrall Lega Zama UNI 3717



Cromo
Polished chrome



Neropaco
Matt black



Nikelnero
Black nickel

Maniglia porta / Door handle

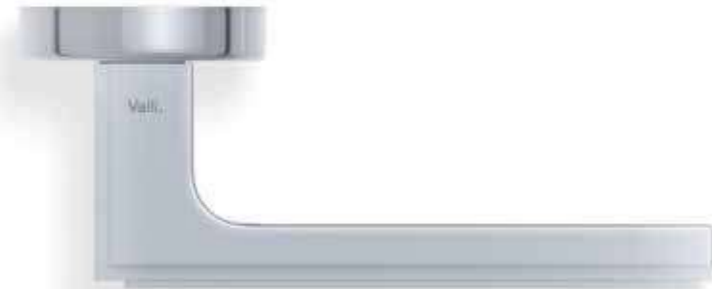
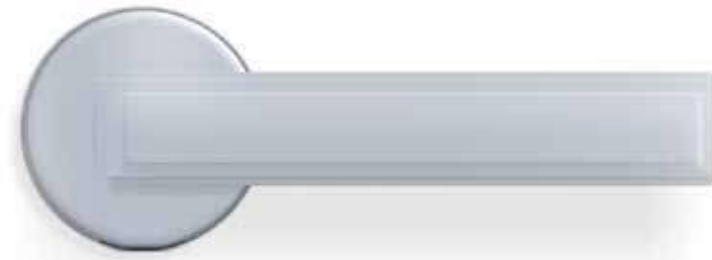

Coordinati / Matches

Finestra / Window handle

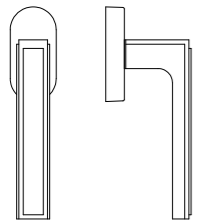

P. 221

Pomolo / Door knob

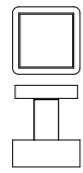

P. 227

Maniglione / Pull handle

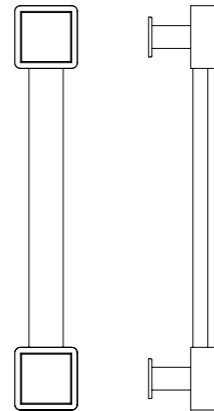

P. 236

In abbinamento sono disponibili / In combination with

Bocchette
Escutcheons
P. 240

Chiusure privacy BZG
Bathroom privacy sets
P. 252



H 1057 Retrò è stata concepita per evocare atmosfere e suggestioni dell'estetica degli anni '30. La maniglia si sviluppa in due parti: il semicilindro principale che alloggia sulla sua superficie, un altro semicilindro, con la stessa sagoma ma più stretto e più lungo, che sporge leggermente all'estremità. / H 1057 Retrò was conceived to evoke 1930s aesthetics. The handle is composed of two parts: a semi-cylindrical housing that tapers towards the tip and a semi-cylindrical inner element that protrudes slightly at the end.

Materiale / Material

Ottone / Brass**Cromo**
Polished chrome**Bronzop**
Matt bronze**Oro lucido**
Polished brass

Maniglia porta / Door handle

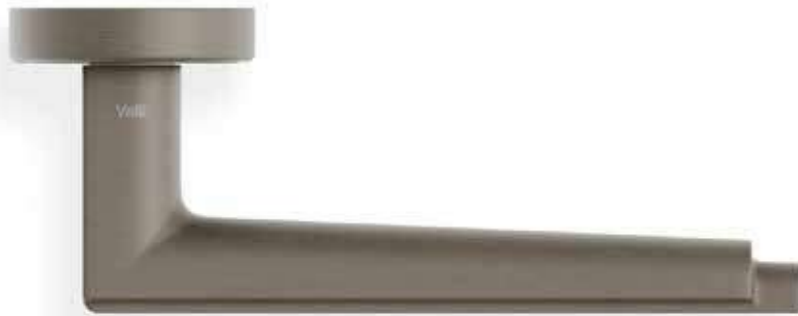

Coordinati / Matches

Finestra / Window handle

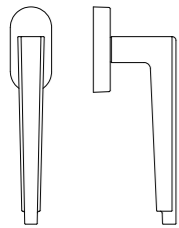

P. 222

In abbinamento sono disponibili / In combination with

Bocchette
Escutcheons
P. 240**Chiusure privacy BZG**
Bathroom privacy sets
P. 252**Disponibile su richiesta Classe 4 secondo la norma EN 1906.**
Upon request, Class 4 is also available according to EN 1906.
P. 295

H 1067 Rose è una maniglia di straordinaria essenzialità. Realizzata in rame dall'inconfondibile coloritura rosata e calda, l'impugnatura è composta dalla forma pura di un unico cilindro di metallo allungato, capace di trasmettere una sensazione di solidità, di semplicità e di grande classe. / H 1067 Rose is extraordinarily minimal. Made entirely of copper, which gives the handle its unmistakable warm pink colour, the lever is a single elongated metal cylinder, which conveys a sensation of solidity, simplicity, and class.

Materiale / Material
Rame / Copper

Maniglia porta / Door handle

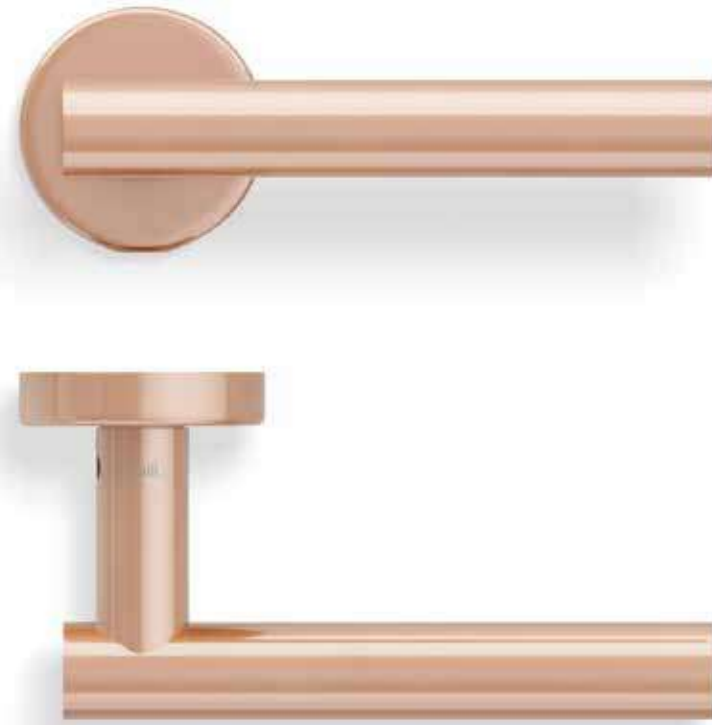

Metallo rame lucido
Polished pure copper



Metallo rame satinato
Satin pure copper

Coordinati / Matches

Finestra / Window handle

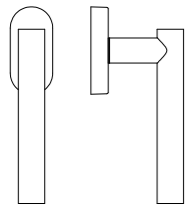

P. 222

Pomolo / Door knob

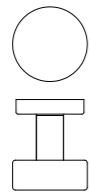

P. 227

Maniglione / Pull handle

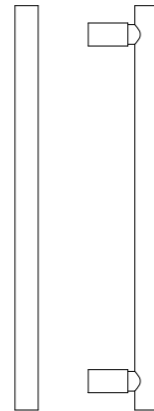

P. 236

In abbinamento sono disponibili / In combination with

Bocchette
Escutcheons
P. 240

Chiusure privacy BZG
Bathroom privacy sets
P. 252



Rose H 1067

H 163 Sarissa è una maniglia che gioca sul perfetto accostamento di linee dritte e superfici curve. Il rigore della leva esattamente orizzontale viene addolcito dalla morbidezza delle stondature mentre l'arco dell'impugnatura dona un leggero ma decisivo dinamismo alla maniglia. / H 163 Sarissa plays on the perfect combination of straight lines and curved surfaces. The precise horizontal lever is softened by rounded edges, while the slightly concave arc of the grip adds a gentle but decisive dynamism.

Materiale / Material
Ottone / Brass

Maniglia porta / Door handle



Cromo
Polished chrome



Cromosat
Satin chrome



Oro lucido
Polished brass

Coordinati / Matches

Finestra / Window handle

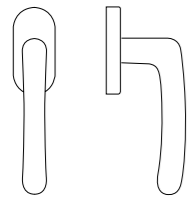

P. 222

Alzante scorrevole / Lift and slide handle

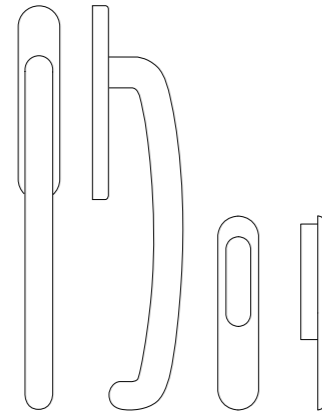

P. 238

In abbinamento sono disponibili / In combination with

Bocchette
Escutcheons
P. 240

Chiusure privacy BZG
Bathroom privacy sets
P. 252



Disponibile su richiesta **Classe 4** secondo la norma EN 1906.
Upon request, Class 4 is also available according to EN 1906.
P. 295

H 176 Spiga è una reinvenzione della maniglia da porta della tradizione e ripropone il sistema della leva in metallo rivestita di porcellana. Le linee della struttura sono aggraziate e stondate, così come l'impugnatura in porcellana che aggiunge varietà ed eleganza alla maniglia.
 H 176 Spiga revisits the porcelain-coated metal lever system of the traditional door handle. Its lines are graceful and rounded, as is the porcelain grip itself, which adds variety and elegance.

Materiale / Material

Ottone + Porcellana
 Brass + Porcelain



Bianco / Oro lucido
 White / Polished brass



Brunito / Avorio
 Burnished / Ivory

Maniglia porta / Door handle



Coordinati / Matches

Finestra / Window handle

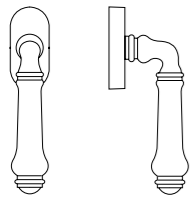

P. 222

In abbinamento sono disponibili / In combination with

Bocchette
 Escutcheons
 P. 240

Chiusure privacy BZG
 Bathroom privacy sets
 P. 252



H 1037 Teseo è un omaggio alle antiche maniglie da porta. La forma è quella affusolata delle maniglie tradizionali, ma il profilo è semplificato e asciugato, con le decorazioni ridotte all'essenziale. / H 1037 Teseo is a tribute to ancient door handles. While it retains the traditional tapered shape, its profile has been simplified and decorations are reduced to a minimum.

Materiale / Material

Ottone / Brass

Maniglia porta / Door handle



Ottone antico
Antique brass



Brunito
Burnished



Orolucido
Polished brass

Coordinati / Matches

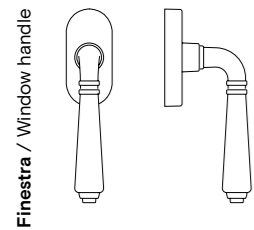

Finestra / Window handle

P. 235

In abbinamento sono disponibili / In combination with

Bocchette
Escutcheons
P. 240

Chiusure privacy BZG
Bathroom privacy sets
P. 252



Teseo H 1037

H 1054 W.W. è un omaggio al design della Bauhaus e si ispira alla celebre maniglia disegnata da Wilhelm Wagenfeld nel 1928, conosciuta come “fischietto”. Il profilo sottile e pulito, senza traccia di superfluo, armonizza il quarto di cerchio che dal perno si allunga con garbo verso la leva. / H 1054 W.W.

is a tribute to Bauhaus design, inspired by the timeless lines of the famous handle designed by Wilhelm Wagenfeld in 1928. The clean profile, without a trace of the superfluous, perfectly balances the quarter-circle that has been gracefully extended to the end of the lever.

Materiale / Material

Ottone / Brass

Maniglia porta / Door handle



Cromo
Polished chrome



Niknatt
Niknatt



Orsato
Matt brass

Coordinati / Matches

Finestra / Window handle

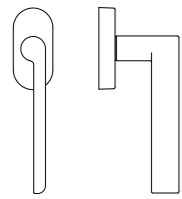

P. 223

Pomolo / Door knob



P. 228

Maniglione / Pull handle

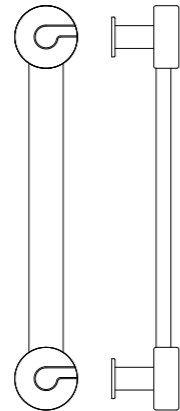

P. 237

In abbinamento sono disponibili / In combination with

Bocchette
Escutcheons
P. 240

Chiusure privacy BZG
Bathroom privacy sets
P. 252



Disponibile su richiesta **Classe 4** secondo la norma EN 1906.
Upon request, Class 4 is also available according to EN 1906.
P. 295

H 414 Amber è un concentrato di semplicità e di ergonomia: la leva è formata da un cilindro che disegna una curva a “U” per garantire la miglior presa possibile. / H 414 Amber is the epitome of simplicity and ergonomics: the lever is formed of a cylinder that curves into a U-shape to guarantee the best possible grip.

Materiale / Material

Acciaio inox AISI 304
Stainless steel AISI 304



Acciaio inox satinato
Satin stainless steel

Maniglia porta / Door handle



Coordinati / Matches

Finestra / Window handle

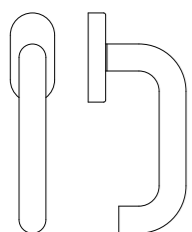

P. 216

In abbinamento sono disponibili / In combination with

Bocchette
Escutcheons
P. 240

Chiusure privacy BZG
Bathroom privacy sets
P. 252



H 419 Bordeaux è una maniglia semplice e lineare nel suo andamento squadrato e regolarissimo. È particolarmente indicata in ambienti contemporanei e moderni.

H 419 Bordeaux is a linear and simple handle, regular and squared shaped. Mostly suitable for contemporary and modern environments.

Materiale / Material

Acciaio inox AISI 304
Stainless steel AISI 304



Acciaio inox satinato
Satin stainless steel

Maniglia porta / Door handle

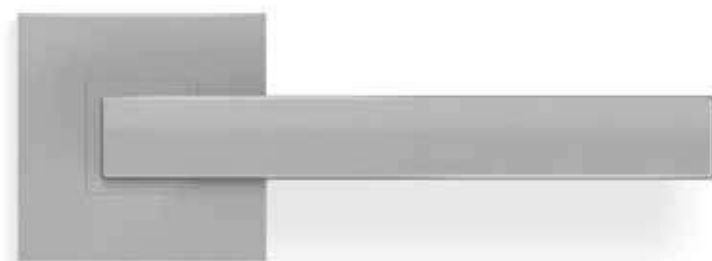

Coordinati / Matches

Finestra / Window handle

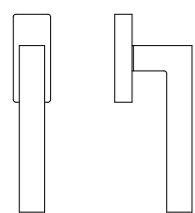

P. 216

In abbinamento sono disponibili / In combination with

Pomoli
Door knobs
P. 224

Bocchette
Escutcheons
P. 240

Chiusure privacy BZG
Bathroom privacy sets
P. 252

H 416 Garnet è un prodotto di grande eleganza e semplicità. Lo stile è sviluppato a partire da un cilindro a sezione regolare, che rende l'impugnatura solida ed essenziale.

H 416 Garnet is simple and extremely elegant. The style develops from a cylindrical base into a regular lever, creating a solid and minimal grip.

Materiale / Material

Acciaio inox AISI 304
Stainless steel AISI 304



Acciaio inox satinato
Satin stainless steel

Maniglia porta / Door handle



Coordinati / Matches

Finestra / Window handle

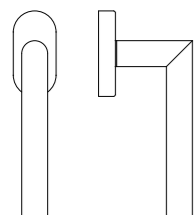

P. 218

In abbinamento sono disponibili / In combination with

Bocchette
Escutcheons
P. 240

Chiusure privacy BZG
Bathroom privacy sets
P. 252

H 411 Leila è una maniglia dal design semplice e lineare. La leva è perfettamente orizzontale e lievemente stondata ai bordi, risultando piacevole e confortevole alla presa.
 H 411 Leila boasts a highly simple and linear design. The lever is perfectly horizontal and slightly rounded at the edges, making it pleasant and comfortable to grip.

Materiale / Material
Ottone / Brass

Maniglia porta / Door handle



Cromo
Polished chrome

Cromosat
Satin chrome

Neropaco
Matt black

Biancopaco
Matt white

Coordinati / Matches

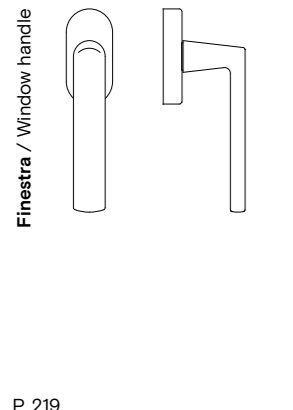

P. 219

In abbinamento sono disponibili / In combination with

Bocchette
Escutcheons
P. 240

Chiusure privacy BZG
Bathroom privacy sets
P. 252



H 411 Q Leila è una maniglia dal design asciutto e un'ergonomia efficace. La rosetta di forma quadrata le conferisce rigore e un segno preciso, senza pregiudicarne l'ergonomia. / H 411 Q Leila boasts a lean design and effective ergonomics. The square rose adds sobriety and a defining feature, without compromising ergonomics.

Materiale / Material
Ottone / Brass

Maniglia porta / Door handle



Cromo
Polished chrome



Cromosat
Satin chrome



Neropaco
Matt black



Biancopaco
Matt white

Coordinati / Matches

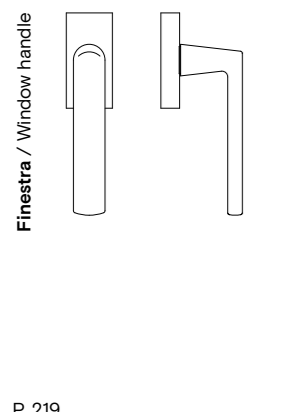

Finestra / Window handle

P. 219

In abbinamento sono disponibili / In combination with

Bocchette
Escutcheons
P. 240

Chiusure privacy BZG
Bathroom privacy sets
P. 252



Coordinati / Matches



Maniglie finestra / Window handles

H 1026 Antonio Bullo - Fusital

Ottone / Brass

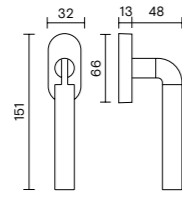

F RS - Movimento a 4 scatti
F RS - Movement 4 click positions

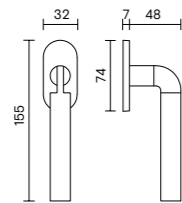

F RS B - Movimento a 8 scatti
F RS B - Movement 8 click positions

- Cromo / Cromosat**
Polished chrome / Satin chrome
- Orsatin / Orolucido**
Satin brass / Polished brass

H 380 Antonio Citterio - Fusital

Ottone / Brass

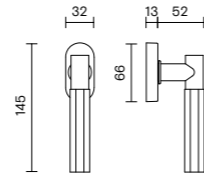

F RS - Movimento a 4 scatti
F RS - Movement 4 click positions

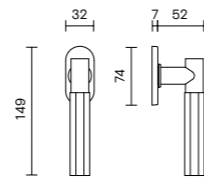

F RS B - Movimento a 8 scatti
F RS B - Movement 8 click positions

- Cromo / Satin bronze**
- Cromosat / Satin chrome**
- Bronzo scuro / Dark bronze**

H 327 Antonio Citterio - Fusital

Ottone / Brass

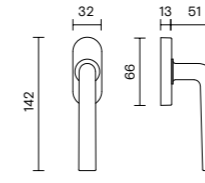

F RS - Movimento a 4 scatti
F RS - Movement 4 click positions

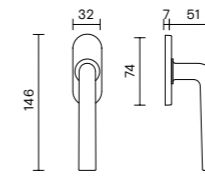

F RS B - Movimento a 8 scatti
F RS B - Movement 8 click positions

- Cromosat / Satin chrome**
- Orolucido / Polished brass**

Prodotto speciale su richiesta:
maniglia da finestra martellina.
Custom made product on request:
window handle - gratz movements.

H 317 Antonio Citterio - Fusital

Ottone / Brass

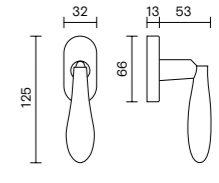

F RS - Movimento a 4 scatti
F RS - Movement 4 click positions

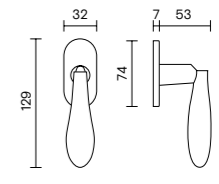

F RS B - Movimento a 8 scatti
F RS B - Movement 8 click positions

- Cromo / Polished chrome**
- Cromosat / Satin chrome**
- Orolucido / Polished brass**

Prodotto speciale su richiesta:
maniglia da finestra martellina.
Custom made product on request:
window handle - gratz movements.

H 379 Antonio Citterio - Fusital

Ottone / Brass

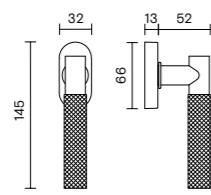

F RS - Movimento a 4 scatti
F RS - Movement 4 click positions

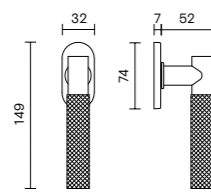

F RS B - Movimento a 8 scatti
F RS B - Movement 8 click positions

- Cromosat / Satin chrome**
- Bronzop / Satin bronze**
- Orsatop / Matt brass**

H 5015 Antonio Citterio - Fusital

Acciaio inox AISI 316 L / Stainless steel AISI 316 L

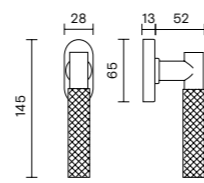

F RS - Movimento a 4 scatti
F RS - Movement 4 click positions

- Acciaio inox lucido**
Polished stainless steel
- Acciaio inox satinato**
Satin stainless steel
- Acciaio inox satinato / Pelle nera**
Satin stainless steel / Black leather
- Acciaio inox satinato / Pelle arancione**
Satin stainless steel / Orange leather

H 361 Antonio Citterio - Toan Nguyen - Fusital

Nikrall Lega Zama UNI 3717

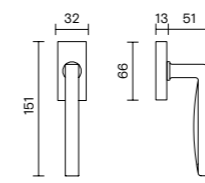

F RS - Movimento a 4 scatti
F RS - Movement 4 click positions

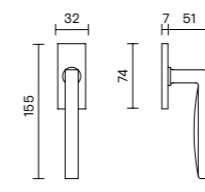

F RS B - Movimento a 8 scatti
F RS B - Movement 8 click positions

- Cromo / Polished chrome**
- Cromosat / Satin chrome**
- Light black / Light black**

Prodotto speciale su richiesta:
maniglia da finestra martellina.
Custom made product on request:
window handle - gratz movements.

H 1066 Bertone Design - Fusital

Ottone / Brass

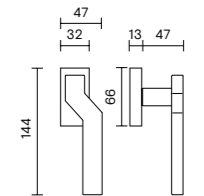

F RS - Movimento a 4 scatti
F RS - Movement 4 click positions

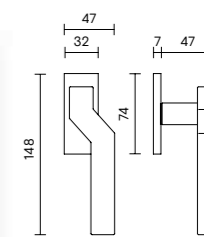

F RS B - Movimento a 8 scatti
F RS B - Movement 8 click positions

- Cromosat / Satin chrome**
- Nikelnero / Black nickel**
- Orsatop / Matt brass**

Maniglie finestra / Window handles

H 384 CetraRuddy Architecture D.P.C. • Fusital

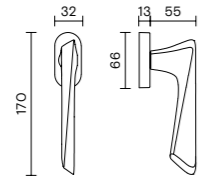

Ottone / Brass

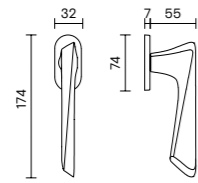

F RS - Movimento a 4 scatti
F RS - Movement 4 click positions



F RS B - Movimento a 8 scatti
F RS B - Movement 8 click positions

-  **Cromosat** / Satin chrome
-  **Bronzo scuro** / Dark bronze
-  **Neropaco** / Matt black

H 368 Cerri & Associati • Fusital

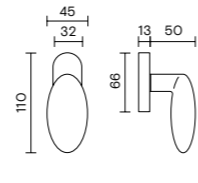

Ottone / Brass

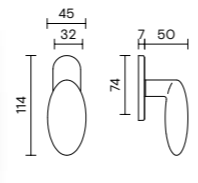

F RS - Movimento a 4 scatti
F RS - Movement 4 click positions



F RS B - Movimento a 8 scatti
F RS B - Movement 8 click positions

-  **Cromo** / Polished chrome
-  **Cromosat** / Satin chrome

H 370 Doriana e Massimiliano Fuksas • Fusital

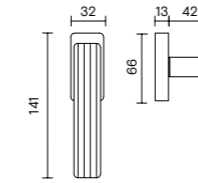

Ottone / Brass

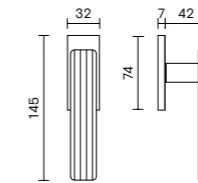

F RS - Movimento a 4 scatti
F RS - Movement 4 click positions



F RS B - Movimento a 8 scatti
F RS B - Movement 8 click positions

-  **Cromo** / Polished chrome
-  **Cromosat** / Satin chrome

H 198 Eero Aarnio • Fusital



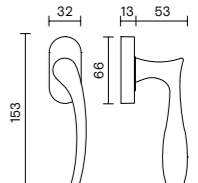

Ottone / Brass

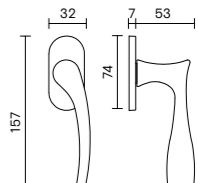

F RS - Movimento a 4 scatti
F RS - Movement 4 click positions



F RS B - Movimento a 8 scatti
F RS B - Movement 8 click positions

-  **Cromosat** / Satin chrome
-  **Anticato** / Antique
-  **Orolucido** / Polished brass
-  **Orsatin** / Satin brass

H 348 David Chipperfield • Fusital

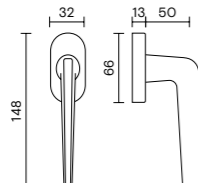

Ottone / Brass

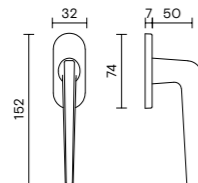

F RS - Movimento a 4 scatti
F RS - Movement 4 click positions



F RS B - Movimento a 8 scatti
F RS B - Movement 8 click positions

-  **Cromo** / Polished chrome
-  **Cromosat** / Satin chrome

Prodotto speciale su richiesta:
maniglia da finestra martellina.
Custom made product on request:
window handle - gratz movements.

H 1061 Di Vittorio Veneziano • Fusital

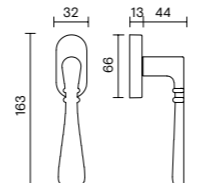

Ottone / Brass

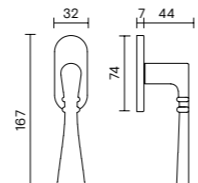

F RS - Movimento a 4 scatti
F RS - Movement 4 click positions



F RS B - Movimento a 8 scatti
F RS B - Movement 8 click positions

-  **Bronzop** / Satin bronze
-  **Light black** / Light black
-  **Orsatin** / Satin brass

H 372 Eri Goshen • Fusital

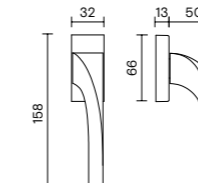

Ottone / Brass

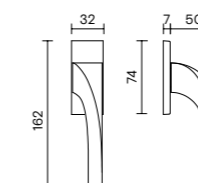

F RS - Movimento a 4 scatti
F RS - Movement 4 click positions



F RS B - Movimento a 8 scatti
F RS B - Movement 8 click positions

-  **Cromo** / Polished chrome
-  **Cromosat** / Satin chrome

H 385 Federica Biasi • Fusital

Nikrall Lega Zama UNI 3717

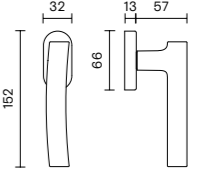

F RS - Movimento a 4 scatti
F RS - Movement 4 click positions

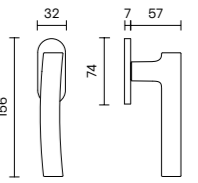

F RS B - Movimento a 8 scatti
F RS B - Movement 8 click positions

-  **Cromo** / Polished chrome
-  **Cromosat** / Satin chrome
-  **Neropaco** / Matt black
-  **Nikelnero** / Black nickel



Maniglie finestra / Window handles

H 334 Foster + Partners · Fusital

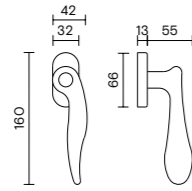
Ottone / Brass



F RS - Movimento a 4 scatti
F RS - Movement 4 click positions

-  **Cromosat** / Satin chrome
-  **Orolucido** / Polished brass

Prodotto speciale su richiesta:
maniglia da finestra martellina.
Custom made product on request:
window handle - gratz movements.

H 374 Franco Poli · Fusital

Ottone / Brass

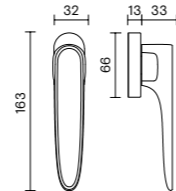

F RS - Movimento a 4 scatti
F RS - Movement 4 click positions

-  **Cromosat** / Satin chrome
-  **Orsatop** / Matt brass

H 367 Giancarlo Vegni · Fusital

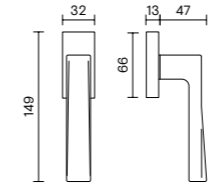

Ottone / Brass

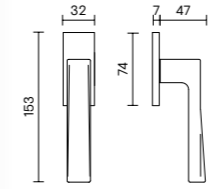

F RS - Movimento a 4 scatti
F RS - Movement 4 click positions



F RS B - Movimento a 8 scatti
F RS B - Movement 8 click positions

-  **Cromo** / Polished chrome
-  **Cromosat** / Satin chrome

H 1039 Jean-Baptiste Sibertin Blanc · Fusital

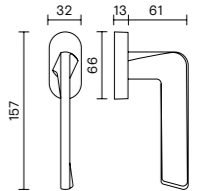

Ottone / Brass

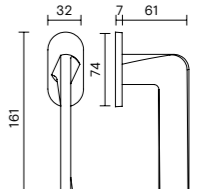

F RS - Movimento a 4 scatti
F RS - Movement 4 click positions



F RS B - Movimento a 8 scatti
F RS B - Movement 8 click positions

-  **Cromosat / Cromo**
Satin chrome / Polished chrome
-  **Orolucido** / Polished brass

H 1040 Gabriele e Oscar Buratti · Fusital

Ottone / Brass

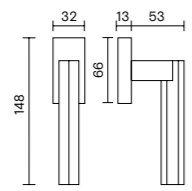
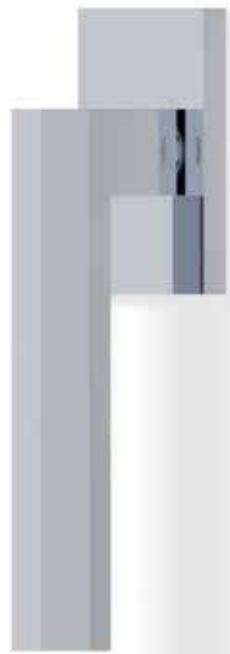

F RS - Movimento a 4 scatti
F RS - Movement 4 click positions

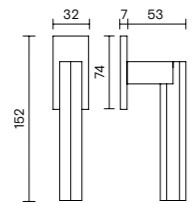

F RS B - Movimento a 8 scatti
F RS B - Movement 8 click positions



-  **Cromo** / Polished chrome
-  **Cromosat** / Satin chrome
-  **Bronzsat** / Bronzsat

H 376 Giancarlo Vegni · Fusital

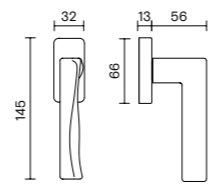
Ottone / Brass



F RS - Movimento a 4 scatti
F RS - Movement 4 click positions

-  **Cromo** / Polished chrome
-  **Cromosat** / Satin chrome
-  **Cromo / Cromosat**
Polished chrome / Satin chrome

H 5017 Hans Kollhoff · Fusital

Acciaio inox AISI 316 L / Stainless steel AISI 316 L

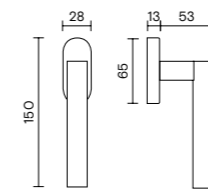

F RS - Movimento a 4 scatti
F RS - Movement 4 click positions

-  **Acciaio inox lucido**
Polished stainless steel
-  **Acciaio inox satinato**
Satin stainless steel

H 382 Joe Cheng · Fusital

Ottone / Brass

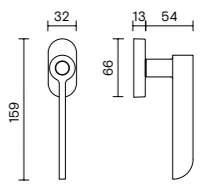

F RS - Movimento a 4 scatti
F RS - Movement 4 click positions

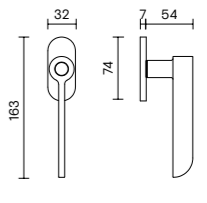

F RS B - Movimento a 8 scatti
F RS B - Movement 8 click positions

-  **Bronzop** / Matt bronze
-  **Orantop** / Antique matte gold
-  **Tortora** / Dove grey

Maniglie finestra / Window handles

H 343 John Pawson • Fusital

Ottone / Brass

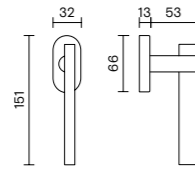

F RS - Movimento a 4 scatti
F RS - Movement 4 click positions

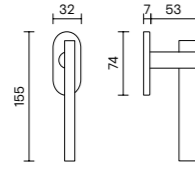

F RS B - Movimento a 8 scatti
F RS B - Movement 8 click positions

Cromo / Polished chrome

Cromosat / Satin chrome

Prodotto speciale su richiesta:
maniglia da finestra martellina.
Custom made product on request:
window handle - gratz movements.

H 381 Khalid Al Najjar • Fusital

Ottone / Brass

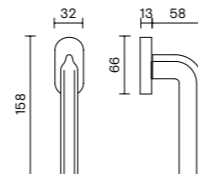

F RS - Movimento a 4 scatti
F RS - Movement 4 click positions

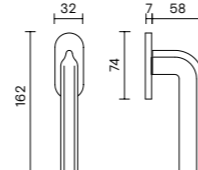

F RS B - Movimento a 8 scatti
F RS B - Movement 8 click positions

Cromosat / Satin chrome

Nikelnero / Black nickel

Orsatop / Matt brass

Titanium PVD / Titanium PVD

H 1043 Matteo Thun • Fusital

Nikrall Lega Zama UNI 3717

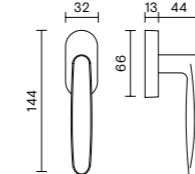

F RS - Movimento a 4 scatti
F RS - Movement 4 click positions

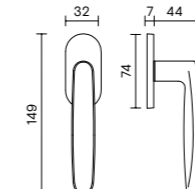

F RS B - Movimento a 8 scatti
F RS B - Movement 8 click positions

Cromo / Cromosat
Polished chrome / Satin chrome

Orolux / Orsatin
Polished brass (for zinc alloy) / Satin brass

H 1003 Matteo Thun • Fusital

Ottone / Brass

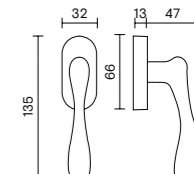

F RS - Movimento a 4 scatti
F RS - Movement 4 click positions

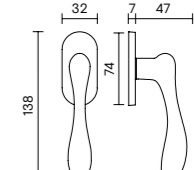

F RS B - Movimento a 8 scatti
F RS B - Movement 8 click positions

Cromosat / Satin chrome

Cromo / Cromosat
Polished chrome / Satin chrome

Anticato / Antique

Orolucido / Orsatin
Polished brass / Satin brass

Orolucido / Polished brass

Orsatin / Satin brass

H 364 Mario Bellini • Fusital

Ottone / Brass

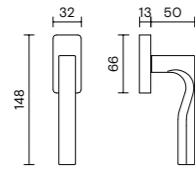

F RS - Movimento a 4 scatti
F RS - Movement 4 click positions

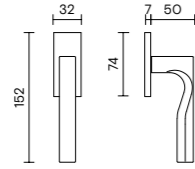

F RS B - Movimento a 8 scatti
F RS B - Movement 8 click positions

Cromo / Polished chrome

Cromosat / Satin chrome

H 311 Mario Bellini • Fusital

Ottone / Brass

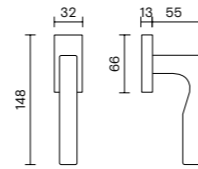

F RS - Movimento a 4 scatti
F RS - Movement 4 click positions

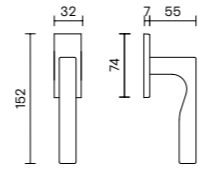

F RS B - Movimento a 8 scatti
F RS B - Movement 8 click positions

Cromo / Polished chrome

Cromosat / Satin chrome

H 330 Matteo Thun • Fusital

Ottone / Brass

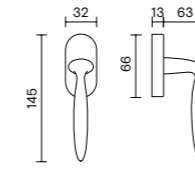

F RS - Movimento a 4 scatti
F RS - Movement 4 click positions

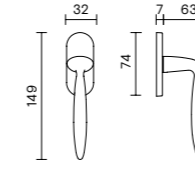

F RS B - Movimento a 8 scatti
F RS B - Movement 8 click positions

Cromosat / Satin chrome

Prodotto speciale su richiesta:
maniglia da finestra martellina.
Custom made product on request:
window handle - gratz movements.

H 386 Meneghello Paoletti • Fusital

Nikrall Lega Zama UNI 3717

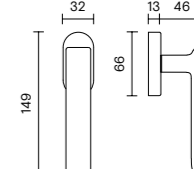

F RS - Movimento a 4 scatti
F RS - Movement 4 click positions

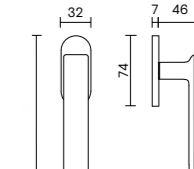

F RS B - Movimento a 8 scatti
F RS B - Movement 8 click positions

Cromo / Polished chrome

Cromosat / Satin chrome

Light black / Light black

Nikelnero / Black nickel

Maniglie finestra / Window handles

H 1052 Mikhail Leykin • Fusital

Ottone / Brass

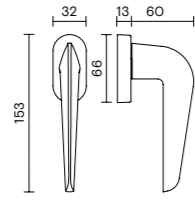

F RS - Movimento a 4 scatti
F RS - Movement 4 click positions

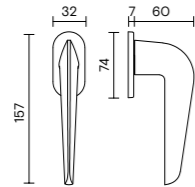

F RS B - Movimento a 8 scatti
F RS B - Movement 8 click positions

- Cromo** / Polished chrome
- Cromosat** / Satin chrome
- Biancopaco** / Matt white
- Bronzop** / Matt bronze
- Neropaco** / Matt black

H 1068 Pembroke & Ives • Fusital

Ottone / Brass

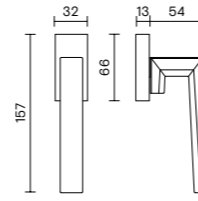

F RS - Movimento a 4 scatti
F RS - Movement 4 click positions

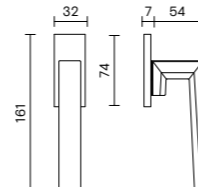

F RS B - Movimento a 8 scatti
F RS B - Movement 8 click positions

- Cromo** / Polished chrome
- Cromosat** / Satin chrome
- Cromo / Cromosat**
Polished chrome / Satin chrome

H 335 Richard Meier • Fusital

Ottone / Brass

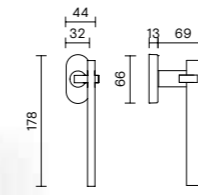

F RS - Movimento a 4 scatti
F RS - Movement 4 click positions

- Cromo** / Polished chrome

Prodotto speciale su richiesta:
maniglia da finestra martellina.
Custom made product on request:
window handle - gratz movements.

H 359 Skidmore, Owings & Merrill • Fusital

Ottone / Brass

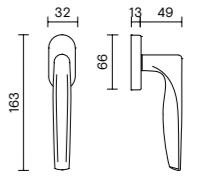

F RS - Movimento a 4 scatti
F RS - Movement 4 click positions

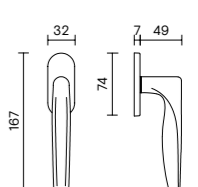

F RS B - Movimento a 8 scatti
F RS B - Movement 8 click positions

- Cromo** / Polished chrome
- Cromosat** / Satin chrome
- Bronzsat** / Bronzsat

H 383 Perkins&Will • Fusital

Ottone / Brass

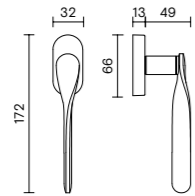

F RS - Movimento a 4 scatti
F RS - Movement 4 click positions

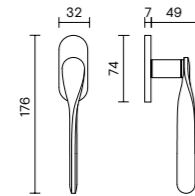

F RS B - Movimento a 8 scatti
F RS B - Movement 8 click positions

- Cromosat** / Satin chrome
- Bronzo scuro** / Dark bronze
- Nikelnero** / Black nickel

H 315 Pierluigi Cerri • Fusital

Ottone + Porcellana / Brass + Porcelain

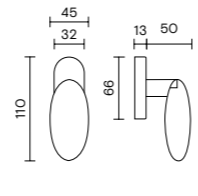

F RS - Movimento a 4 scatti
F RS - Movement 4 click positions

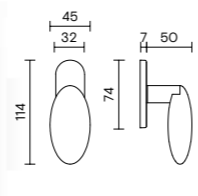

F RS B - Movimento a 8 scatti
F RS B - Movement 8 click positions

- Cromo** / Polished chrome
- Orolucido** / Polished brass

Prodotto speciale su richiesta:
maniglia da finestra martellina.
Custom made product on request:
window handle - gratz movements.

H 377 Steve Leung • Fusital

Ottone / Brass

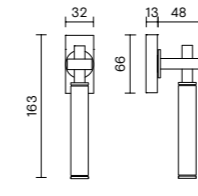

F RS - Movimento a 4 scatti
F RS - Movement 4 click positions

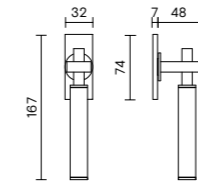

F RS B - Movimento a 8 scatti
F RS B - Movement 8 click positions

- Bronzo scuro / Pelle nera**
Dark bronze / Black leather
- Bronzo scuro** / Satin chrome
- Neropaco** / Matt black
- Nikelnero** / Black nickel
- Titanium PVD** / Titanium PVD

H 377 P Steve Leung • Fusital

Ottone / Brass

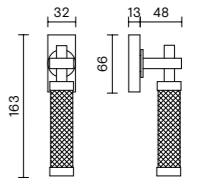

F RS - Movimento a 4 scatti
F RS - Movement 4 click positions

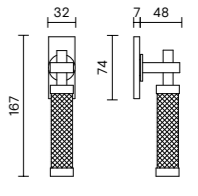

F RS B - Movimento a 8 scatti
F RS B - Movement 8 click positions

- Bronzo scuro / Pelle marrone**
Dark bronze / Brown leather

Maniglie finestra / Window handles

H 329 Taller Design Ricardo Bofill • Fusital

Ottone / Brass

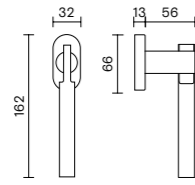

F RS - Movimento a 4 scatti
F RS - Movement 4 click positions

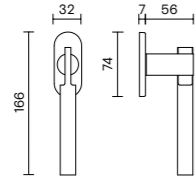

F RS B - Movimento a 8 scatti
F RS B - Movement 8 click positions

- Cromo / Cromosat**
Polished chrome / Satin chrome
- Orolucido / Orsatin**
Polished brass / Satin brass

Prodotto speciale su richiesta:
maniglia da finestra martellina.
Custom made product on request:
window handle - gratz movements.

H 5008 Taller Design Ricardo Bofill • Fusital

Acciaio inox AISI 316 L / Stainless steel AISI 316 L

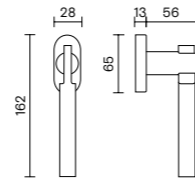

F RS - Movimento a 4 scatti
F RS - Movement 4 click positions

- Acciaio inox satinato**
Satin stainless steel

H 378 Yabu Pushelberg • Fusital

Ottone / Brass

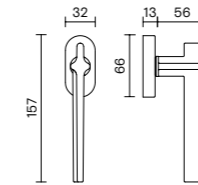

F RS - Movimento a 4 scatti
F RS - Movement 4 click positions

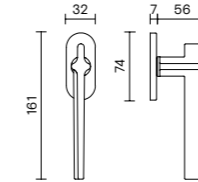

F RS B - Movimento a 8 scatti
F RS B - Movement 8 click positions

- Cromo / Polished chrome**
- Bronzo scuro / Dark bronze**
- Light black / Light black**

H 338 Yoshimi Kono • Fusital

Ottone / Brass

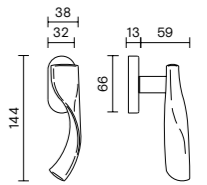

F RS - Movimento a 4 scatti
F RS - Movement 4 click positions

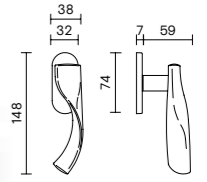

F RS B - Movimento a 8 scatti
F RS B - Movement 8 click positions

- Cromosat / Satin chrome**

H 1044 Vincent Van Duysen • Fusital

Nikrall Lega Zama UNI 3717

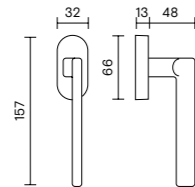

F RS - Movimento a 4 scatti
F RS - Movement 4 click positions

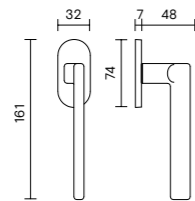

F RS B - Movimento a 8 scatti
F RS B - Movement 8 click positions

- Cromo / Polished chrome**
- Cromosat / Satin chrome**
- Neropaco / Matt black**

H 1044 Q Vincent Van Duysen • Fusital

Nikrall Lega Zama UNI 3717

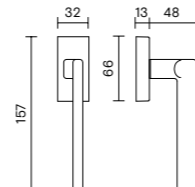

F RS - Movimento a 4 scatti
F RS - Movement 4 click positions

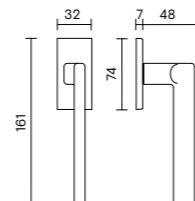

F RS B - Movimento a 8 scatti
F RS B - Movement 8 click positions

- Cromo / Polished chrome**
- Cromosat / Satin chrome**
- Neropaco / Matt black**

H 1045 Yoshimi Kono • Fusital

Ottone / Brass

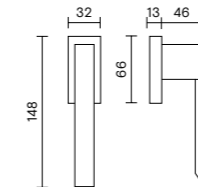

F RS - Movimento a 4 scatti
F RS - Movement 4 click positions

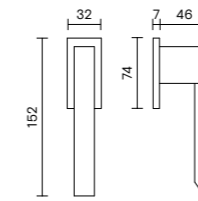

F RS B - Movimento a 8 scatti
F RS B - Movement 8 click positions

- Cromo / Polished chrome**
- Cromosat / Satin chrome**
- Cromo / Cromosat**
Polished chrome / Satin chrome
- Nikelnero / Black nickel**

H 356 Zaha Hadid • Fusital

Nikrall Lega Zama UNI 3717

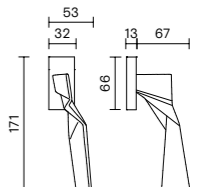

F RS - Movimento a 4 scatti
F RS - Movement 4 click positions

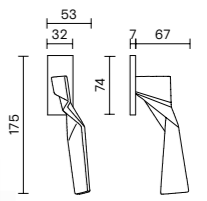

F RS B - Movimento a 8 scatti
F RS B - Movement 8 click positions

- Cromo / Polished chrome**
- Cromosat / Satin chrome**

Maniglie finestra / Window handles

H 414 Amber · Lab

Stainless steel AISI 304 / Acciaio inox AISI 304

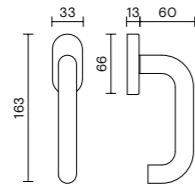

F RS - Movimento a 4 scatti
F RS - Movement 4 click positions

● **Acciaio inox satinato**
Satin stainless steel

H 1058 Amica · Lab

Nikral Lega Zama UNI 3717

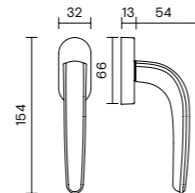

F RS - Movimento a 4 scatti
F RS - Movement 4 click positions

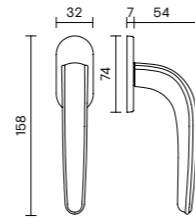

F RS B - Movimento a 8 scatti
F RS B - Movement 8 click positions

● **Cromo / Cromosat**
Polished chrome / Satin chrome
● **Biancopaco** / Matt white
● **Nikelnero** / Black nickel

H 1062 Carmen · Lab

Ottone / Brass

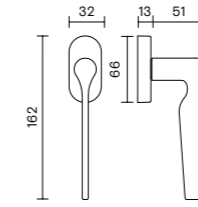

F RS - Movimento a 4 scatti
F RS - Movement 4 click positions

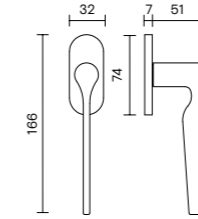

F RS B - Movimento a 8 scatti
F RS B - Movement 8 click positions

● **Cromosat** / Satin chrome
● **Bronzop** / Matt bronze
● **Neropaco** / Matt black
● **Nikelnero** / Black nickel

H 1027 Dafne · Lab

Ottone / Brass

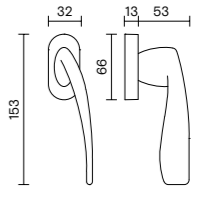

F RS - Movimento a 4 scatti
F RS - Movement 4 click positions

● **Cromosat** / Satin chrome
● **Orolucido** / Polished brass

H 1004 Antares · Lab

Ottone / Brass
Ottone + Porcellana / Brass + Porcelain

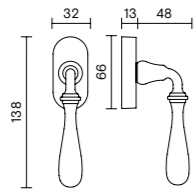

F RS - Movimento a 4 scatti
F RS - Movement 4 click positions

● **Brunito / Avorio**
Burnished / Ivory
● **Brunito** / Burnished
● **Orolucido** / Polished brass
● **Ottone naturale** / Natural brass

H 419 Bordeaux · Lab

Stainless steel AISI 304 / Acciaio inox AISI 304

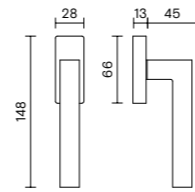

F RS - Movimento a 4 scatti
F RS - Movement 4 click positions

● **Acciaio inox satinato**
Satin stainless steel

H 1049 Divara · Lab

Ottone / Brass

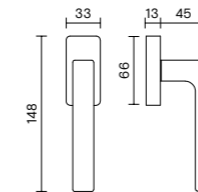

F RS - Movimento a 4 scatti
F RS - Movement 4 click positions

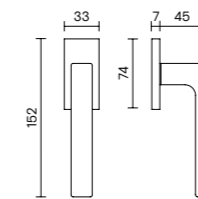

F RS B - Movimento a 8 scatti
F RS B - Movement 8 click positions

● **Cromo** / Polished chrome
● **Cromosat** / Satin chrome
● **Light black** / Light black
● **Neropaco** / Matt black

H 1049 T Divara · Lab

Ottone / Brass

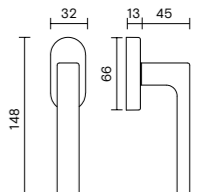

F RS - Movimento a 4 scatti
F RS - Movement 4 click positions

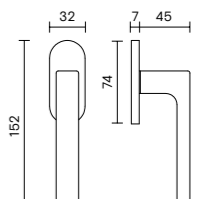

F RS B - Movimento a 8 scatti
F RS B - Movement 8 click positions

● **Cromo** / Polished chrome
● **Cromosat** / Satin chrome
● **Light black** / Light black
● **Neropaco** / Matt black

Maniglie finestra / Window handles

H 1022 Ernani • Lab

Ottone / Brass

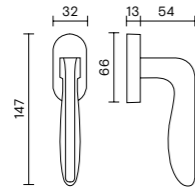

F RS - Movimento a 4 scatti
F RS - Movement 4 click positions

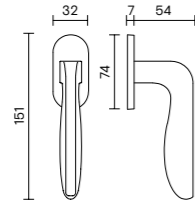

F RS B - Movimento a 8 scatti
F RS B - Movement 8 click positions

- Cromo / Cromosat**
Polished chrome / Satin chrome
- Orolucido / Orsatin**
Polished brass / Satin brass

H 416 Garnet • Lab

Stainless steel AISI 304 / Acciaio inox AISI 304

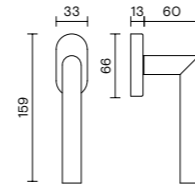

F RS - Movimento a 4 scatti
F RS - Movement 4 click positions

- Acciaio inox satinato**
Satin stainless steel

H 411 Leila • Lab

Ottone / Brass

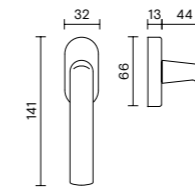

F RS - Movimento a 4 scatti
F RS - Movement 4 click positions

- Cromo / Polished bronze**
- Cromosat / Satin chrome**
- Biancopaco / Matt white**
- Neropaco / Matt black**

H 411 Q Leila • Lab

Ottone / Brass

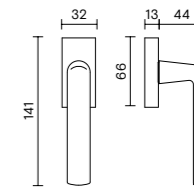

F RS - Movimento a 4 scatti
F RS - Movement 4 click positions

- Cromo / Polished bronze**
- Cromosat / Satin chrome**
- Biancopaco / Matt white**
- Neropaco / Matt black**

H 165 Germana • Lab

Ottone / Brass

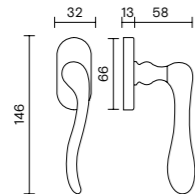

F RS - Movimento a 4 scatti
F RS - Movement 4 click positions

- Anticato / Antique**
- Orolucido / Polished brass**
- Orsatin / Satin brass**

H 1050 Giasone • Lab

Ottone / Brass

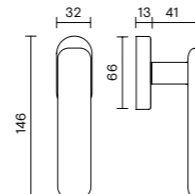

F RS - Movimento a 4 scatti
F RS - Movement 4 click positions

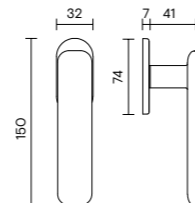

F RS B - Movimento a 8 scatti
F RS B - Movement 8 click positions

- Cromo / Polished bronze**
- Cromosat / Satin chrome**
- Orsatin / Satin brass**

H 1024 Lolita • Lab

Ottone / Brass

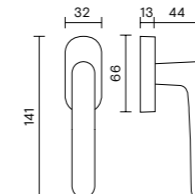

F RS - Movimento a 4 scatti
F RS - Movement 4 click positions

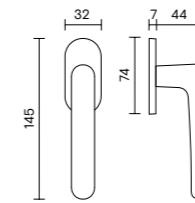

F RS B - Movimento a 8 scatti
F RS B - Movement 8 click positions

- Cromo / Polished chrome**
- Cromosat / Satin chrome**
- Orolucido / Polished brass**

H 123 Luigi XVI • Lab

Ottone / Brass

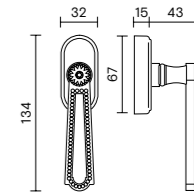

F RS - Movimento a 4 scatti
F RS - Movement 4 click positions

- Ottone antico / Antique brass**
- Orolucido / Polished brass**



Maniglie finestra / Window handles

H 1016 Nabucco · Lab

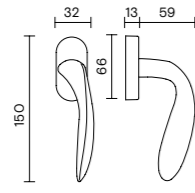
Ottone / Brass



F RS - Movimento a 4 scatti
F RS - Movement 4 click positions

-  **Cromosat** / Satin chrome
-  **Anticato** / Antique
-  **Orolucido** / Polished brass

H 1046 Nais · Lab

Ottone / Brass

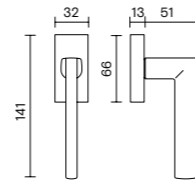

F RS - Movimento a 4 scatti
F RS - Movement 4 click positions

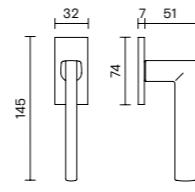

F RS B - Movimento a 8 scatti
F RS B - Movement 8 click positions



-  **Cromo** / Polished chrome
-  **Cromosat** / Satin chrome
-  **Neropaco** / Matt black

H 1065 Naked Due · Lab

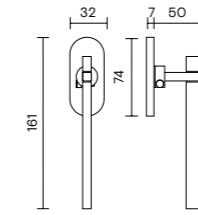
Acciaio C40 + Ottone / Steel C40 + Brass



F RS - Movimento a 4 scatti
F RS - Movement 4 click positions

-  **Cromo** / Polished chrome
-  **Cromosat** / Satin chrome
-  **Nikelnero** / Black nickel

H 192 Prunus · Lab

Ottone / Brass

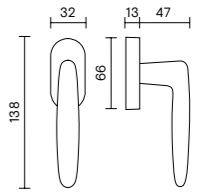

F RS - Movimento a 4 scatti
F RS - Movement 4 click positions

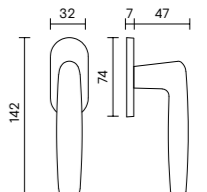

F RS B - Movimento a 8 scatti
F RS B - Movement 8 click positions

-  **Nikmatt** / Nikmatt

H 1046 T Nais · Lab

Ottone / Brass

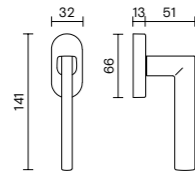

F RS - Movimento a 4 scatti
F RS - Movement 4 click positions

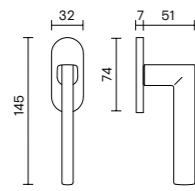

F RS B - Movimento a 8 scatti
F RS B - Movement 8 click positions



-  **Cromo** / Polished chrome
-  **Cromosat** / Satin chrome
-  **Neropaco** / Matt black

H 1064 Naked · Lab

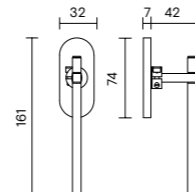
Acciaio C40 / Steel C40



F RS - Movimento a 4 scatti
F RS - Movement 4 click positions

-  **Cromosat** / Satin chrome
-  **Biancopaco** / Matt white
-  **Neropaco** / Matt black

H 1056 Quadra · Lab

Nikrall Lega Zama UNI 3717

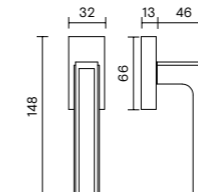

F RS - Movimento a 4 scatti
F RS - Movement 4 click positions

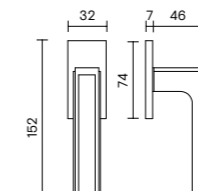

F RS B - Movimento a 8 scatti
F RS B - Movement 8 click positions

-  **Cromo** / Polished chrome
-  **Neropaco** / Matt black
-  **Nikelnero** / Black nickel

H 1056 T Quadra · Lab

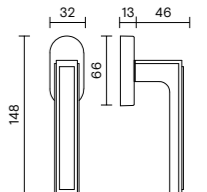

Nikrall Lega Zama UNI 3717

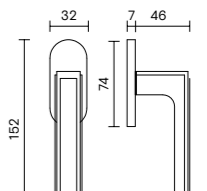

F RS - Movimento a 4 scatti
F RS - Movement 4 click positions



F RS B - Movimento a 8 scatti
F RS B - Movement 8 click positions

-  **Cromo** / Polished chrome
-  **Neropaco** / Matt black
-  **Nikelnero** / Black nickel



Maniglie finestra / Window handles

H 1057 Retrò · Lab

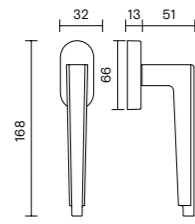
Ottone / Brass



F RS - Movimento a 4 scatti
F RS - Movement 4 click positions



-  **Cromo** / Polished chrome
-  **Bronzop** / Matt bronze
-  **Orolucido** / Polished brass

H 1067 Rose · Lab

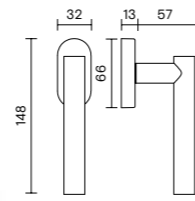
Rame / Copper



F RS - Movimento a 4 scatti
F RS - Movement 4 click positions



-  **Metallo rame lucido** / Polished pure copper
-  **Metallo rame satinato** / Satin pure copper

H 1037 Teseo · Lab

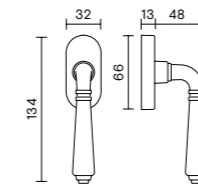
Ottone / Brass



F RS - Movimento a 4 scatti
F RS - Movement 4 click positions

-  **Ottone antico** / Antique brass
-  **Brunito** / Burnished
-  **Orolucido** / Polished brass

H 1054 W.W. · Lab

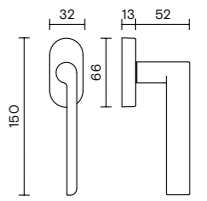

Ottone / Brass

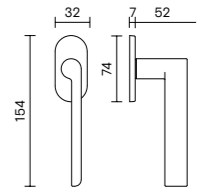

F RS - Movimento a 4 scatti
F RS - Movement 4 click positions



F RS B - Movimento a 8 scatti
F RS B - Movement 8 click positions

-  **Cromo** / Polished chrome
-  **Nikmatt** / Nikmatt
-  **Orsatop** / Polished brass

H 163 Sarissa · Lab

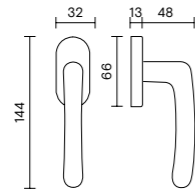

Ottone / Brass

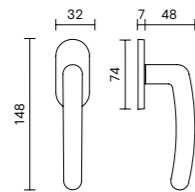

F RS - Movimento a 4 scatti
F RS - Movement 4 click positions



F RS B - Movimento a 8 scatti
F RS B - Movement 8 click positions



-  **Cromo** / Polished chrome
-  **Cromosat** / Satin chrome
-  **Orolucido** / Polished brass

H 176 Spiga · Lab

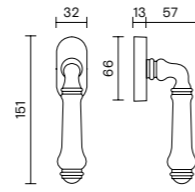
Ottone + Porcellana / Brass + Porcelain



F RS - Movimento a 4 scatti
F RS - Movement 4 click positions

-  **Orolucido / Bianco**
Polished brass / White
-  **Brunito / Avorio**
Burnished / Ivory

Pomoli / Door knobs

K 383 Perkins&Will · Fusital

Ottone / Brass

-  Cromosat
Satin chrome
-  Bronzo scuro
Dark bronze
-  Nikelnero
Black nickel

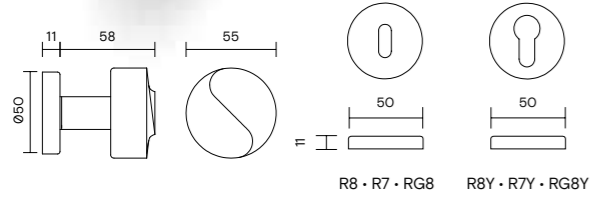

K 383 B Perkins&Will · Fusital



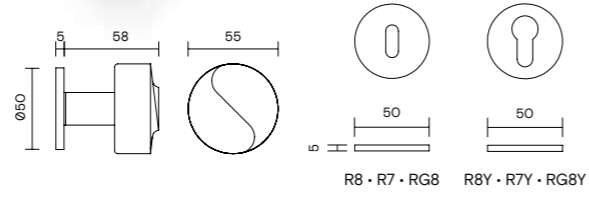

Ottone / Brass

-  Cromosat
Satin chrome
-  Bronzo scuro
Dark bronze
-  Nikelnero
Black nickel



K 376 Giancarlo Vegni · Fusital



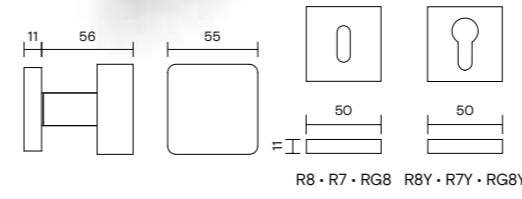

Alluminio / Aluminium

-  Cromo
Polished chrome
-  Cromosat
Satin chrome
-  Cromo / Cromosat
Polished chrome /
Satin chrome
-  Bronzsat
Bronzsat



K 376 B Giancarlo Vegni · Fusital

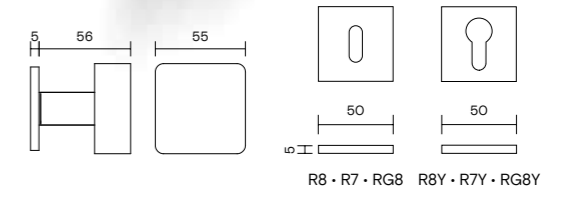

Alluminio / Aluminium

-  Cromo
Polished chrome
-  Cromosat
Satin chrome
-  Cromo / Cromosat
Polished chrome /
Satin chrome
-  Bronzsat
Bronzsat



K 378 Yabu Pushelberg · Fusital

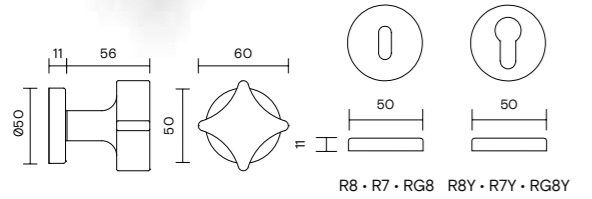

Ottone / Brass

-  Cromo
Polished chrome
-  Bronzo scuro
Dark bronze
-  Light black
Light black



K 378 B Yabu Pushelberg · Fusital





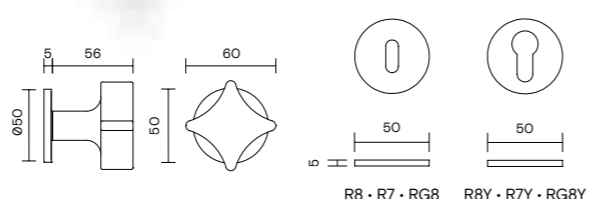

Ottone / Brass

-  Cromo
Polished chrome
-  Bronzo scuro
Dark bronze
-  Light black
Light black



K 374 Franco Poli · Fusital





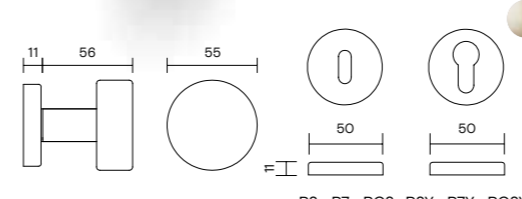

Alluminio / Aluminium

-  Cromo
Polished chrome
-  Cromosat
Satin chrome
-  Biancopaco
Matt white
-  Bronzop
Matt bronze
-  Bronzsat
Bronzsat
-  Neropaco
Matt black
-  Orsatop
Matt brass



K 374 B Franco Poli · Fusital



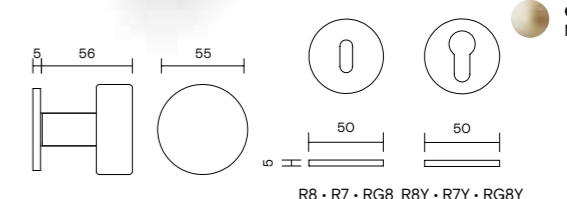

Alluminio / Aluminium

-  Cromo
Polished chrome
-  Cromosat
Satin chrome
-  Biancopaco
Matt white
-  Bronzop
Matt bronze
-  Bronzsat
Bronzsat
-  Neropaco
Matt black
-  Orsatop
Matt brass



K 377 Steve Leung · Fusital



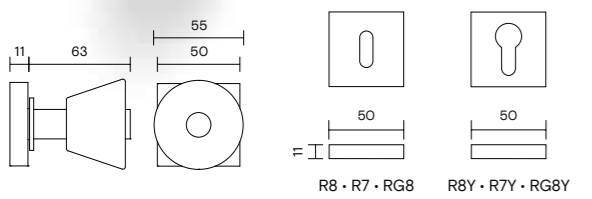

Ottone / Brass

-  Bronzo scuro
Dark bronze
-  Neropaco
Matt black
-  Nikelnero
Black nickel
-  Titanium PVD
Titanium PVD



K 377 B Steve Leung · Fusital

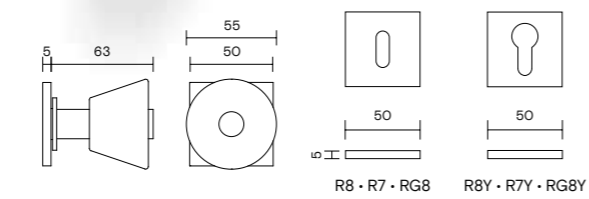

Ottone / Brass

-  Bronzo scuro
Dark bronze
-  Neropaco
Matt black
-  Nikelnero
Black nickel
-  Titanium PVD
Titanium PVD



K 1061 Di Virgilio Veneziano · Fusital

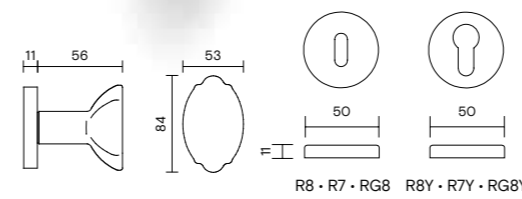

Ottone / Brass

-  Bronzop
Matt bronze
-  Light black
Light black
-  Orsatin
Satin brass



K 1061 B Di Virgilio Veneziano · Fusital

Ottone / Brass



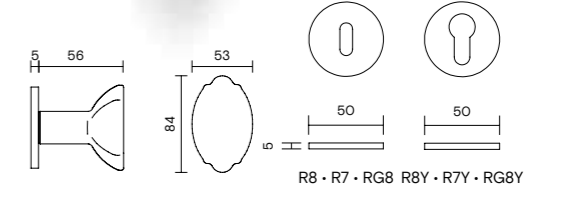

-  Bronzop
Matt bronze
-  Light black
Light black
-  Orsatin
Satin brass



Pomoli / Door knobs

K 1730 A · Lab

Ottone / Brass

-  Cromo
Polished chrome
-  Cromosat
Satin chrome
-  Nikmatt
Nikmatt
-  Orolucido
Polished brass

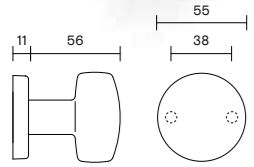

Pomolo fisso.
Fixed knob.

K 1171 · Lab

Alluminio / Aluminium



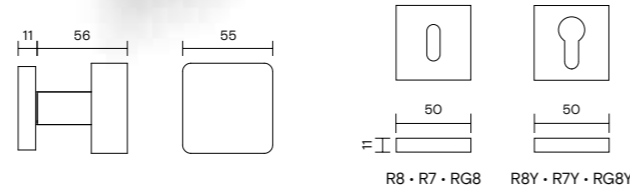



-  Cromo
Polished chrome
-  Cromosat
Satin chrome
-  Bronzsat
Bronzsat



R8 · R7 · RG8 R8Y · R7Y · RG8Y

K 1155 A · Lab

Ottone / Brass



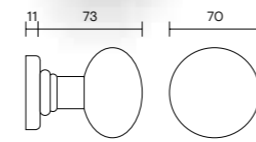



-  Cromo
Polished chrome
-  Cromosat
Satin chrome
-  Anticato
Antique
-  Brunito
Burnished
-  Orolucido
Polished brass
-  Orsatin
Satin brass
-  Orolucido PVD
Polished brass PVD



Pomolo fisso.
Fixed knob.

K 1155 · Lab

Ottone / Brass

-  Cromo
Polished chrome
-  Cromosat
Satin chrome
-  Anticato
Antique
-  Brunito
Burnished
-  Orolucido
Polished brass
-  Orsatin
Satin brass
-  Ottone naturale
Natural brass

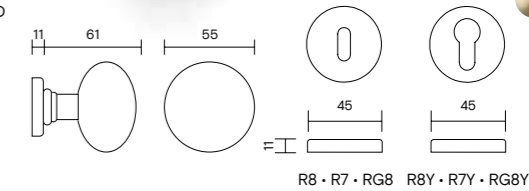

R8 · R7 · RG8 R8Y · R7Y · RG8Y

K 1168 · Lab

Ottone / Brass

-  Cromo
Polished chrome
-  Cromosat
Satin chrome
-  Orsatin
Satin brass

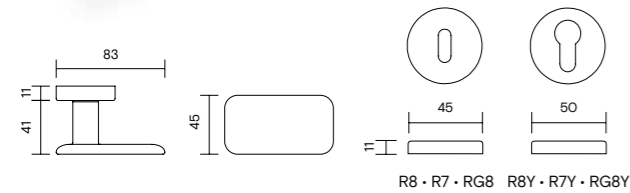

R8 · R7 · RG8 R8Y · R7Y · RG8Y

K 1168 B · Lab

Ottone / Brass

-  Cromo
Polished chrome
-  Cromosat
Satin chrome
-  Orsatin
Satin brass

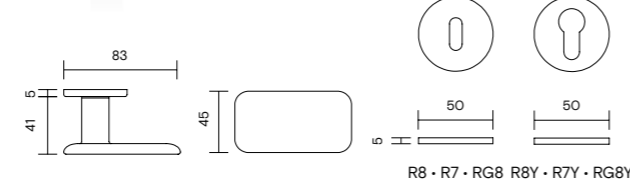

R8 · R7 · RG8 R8Y · R7Y · RG8Y

K 1153 · Lab

Ottone / Brass

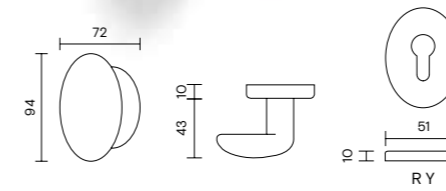

-  Cromosat
Satin chrome
-  Orolucido
Polished brass
-  Orolucido PVD
Polished brass PVD



R Y

K 1153 PY D/S B · Lab

Ottone / Brass

-  Cromosat
Satin chrome
-  Orolucido
Polished brass

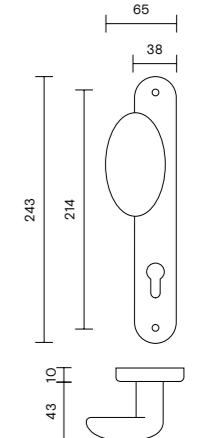

K 1166 A · Lab

Nikrall Lega Zama UNI 3717

-  Cromo
Polished chrome
-  Cromosat
Satin chrome
-  Orolucido PVD
Polished brass PVD

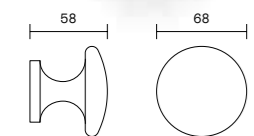

Pomolo fisso.
Fixed knob.

K 1160 · Lab

Ottone / Brass

-  Cromosat
Satin chrome
-  Orolucido
Polished brass
-  Ottone naturale
Natural brass
-  Orolucido PVD
Polished brass PVD

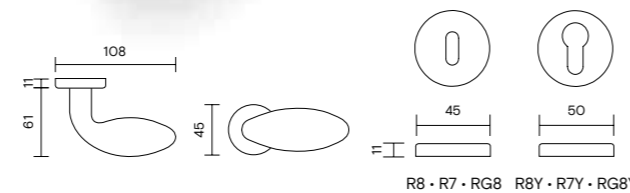

R8 · R7 · RG8 R8Y · R7Y · RG8Y

K 1067 Rose · Lab

Rame / Copper

-  Metallo rame lucido
Polished pure copper
-  Metallo rame satinato
Satin pure copper

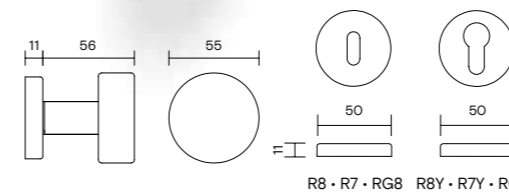

R8 · R7 · RG8 R8Y · R7Y · RG8Y

K 1056 T Quadra · Lab

Alluminio / Aluminium

-  Cromo
Polished chrome
-  Neropaco
Matt black
-  Nikelnero
Black nickel

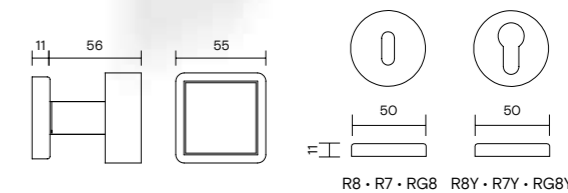

R8 · R7 · RG8 R8Y · R7Y · RG8Y

Pomoli / Door knobs

K 1056 B T Quadra • Lab

Alluminio / Aluminium

-  **Cromo**
Polished chrome
-  **Neropaco**
Matt black
-  **Nikelnero**
Black nickel

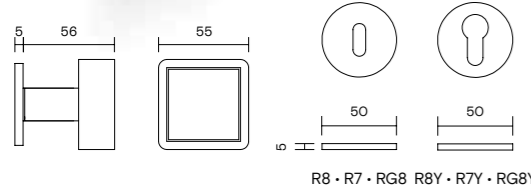

K 1056 Quadra • Lab

Alluminio / Aluminium

-  **Cromo**
Polished chrome
-  **Neropaco**
Matt black
-  **Nikelnero**
Black nickel

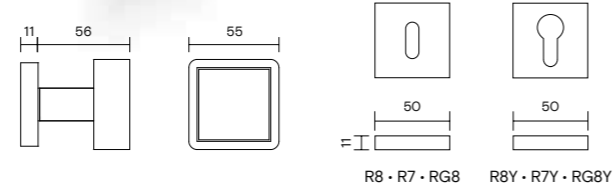

K 121 Luigi XVI • Lab

Ottone / Brass

-  **Orolucido**
Polished brass
-  **Ottone antico**
Antique brass

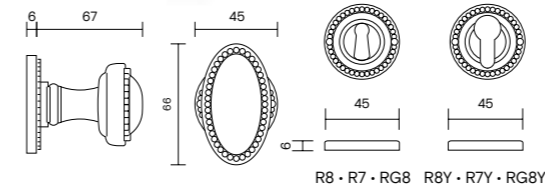

K 5304 Foster + Partners • Fusital

Acciaio inox AISI 316 L / Stainless steel AISI 316 L

-  **Acciaio inox satinato**
Satin stainless steel
-  **Acciaio inox lucido**
Polished stainless steel

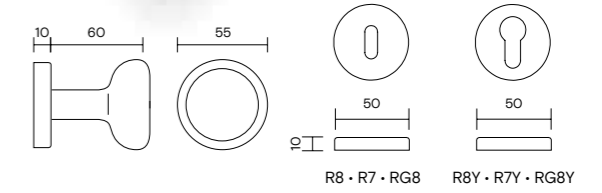

K 1056 B Quadra • Lab

Alluminio / Aluminium

-  **Cromo**
Polished chrome
-  **Neropaco**
Matt black
-  **Nikelnero**
Black nickel

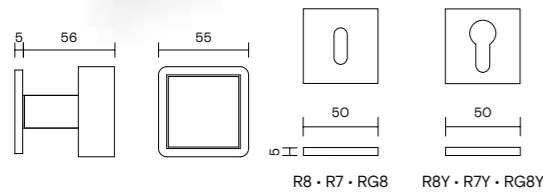

K 1054 W.W. • Lab

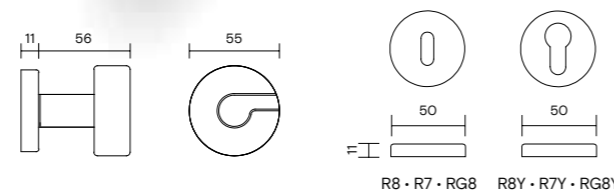

Alluminio / Aluminium

-  **Cromo**
Polished chrome
-  **Nikmatt**
Nikmatt
-  **Orsatop**
Matt brass



K 5301 • Fusital

Acciaio inox AISI 316 L / Stainless steel AISI 316 L

-  **Acciaio inox satinato**
Satin stainless steel
-  **Acciaio inox lucido**
Polished stainless steel

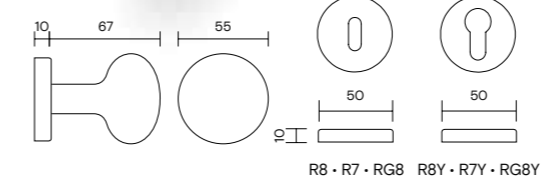

K 465 • Lab

Acciaio inox AISI 304 / Stainless steel AISI 304

-  **Acciaio inox satinato**
Satin stainless steel

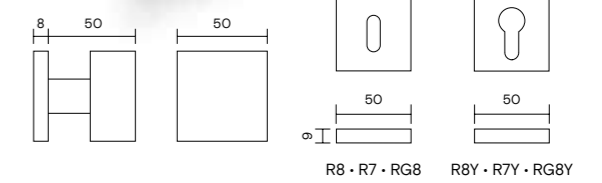

K 1054 B W.W. • Lab

Alluminio / Aluminium

-  **Cromo**
Polished chrome
-  **Nikmatt**
Nikmatt
-  **Orsatop**
Matt brass

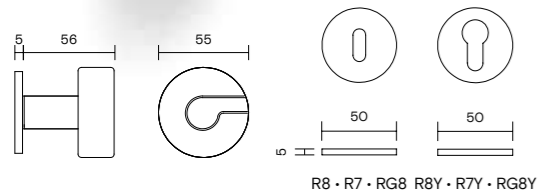

K 142 • Lab

Ottone / Brass

-  **Cromo**
Polished chrome
-  **Cromosat**
Satin chrome
-  **Orolucido**
Polished brass

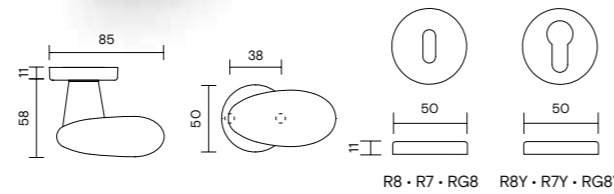



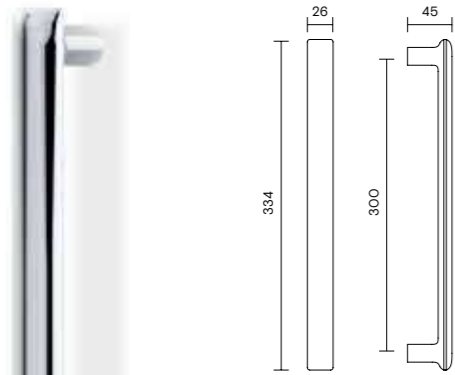

Maniglioni / Pull handles

K 386 Meneghello Paoelli • Fusital

Ottone / Brass





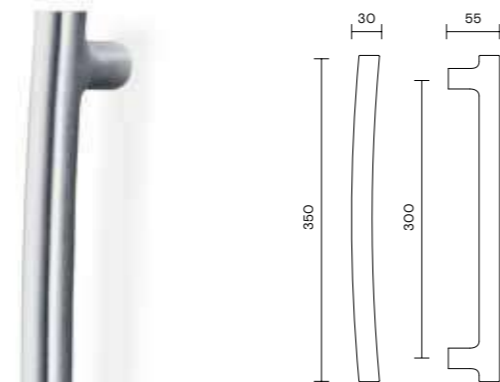

-  **Cromo** / Polished chrome
-  **Cromosat** / Satin chrome
-  **Light black** / Light black
-  **Nikelnero** / Black nickel

NEW K 385 Federica Biasi • Fusital

Ottone / Brass





-  **Cromo** / Polished chrome
-  **Cromosat** / Satin chrome
-  **Nikelnero** / Black nickel
-  **Neropaco** / Matt black

K 380 Antonio Citterio • Fusital

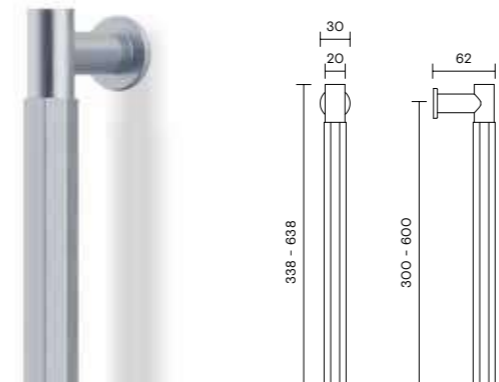
Ottone / Brass





-  **Cromo** / Polished chrome
-  **Cromosat** / Satin chrome
-  **Bronzo scuro** / Dark bronze

K 379 Antonio Citterio • Fusital

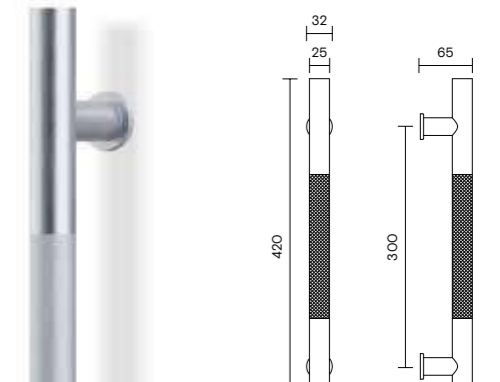
Ottone / Brass





-  **Cromosat** / Satin chrome
-  **Bronzop** / Matt bronze
-  **Orsatop** / Matt brass

K 383 Perkins & Will • Fusital

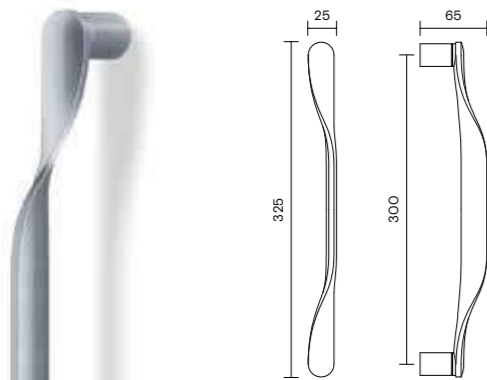
Ottone / Brass



-  **Cromosat** / Satin chrome
-  **Bronzo scuro** / Dark bronze
-  **Nikelnero** / Black nickel

K 381 Khalid Al Najjar • Fusital

Ottone / Brass

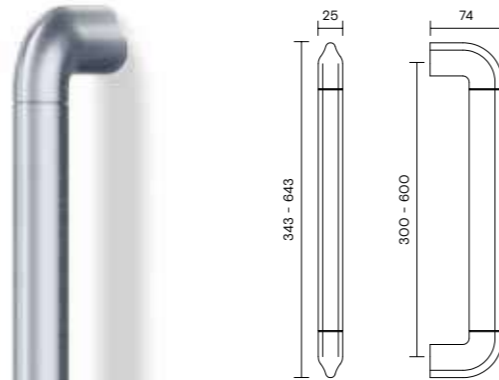



-  **Cromosat** / Satin chrome
-  **Orsatop** / Matt brass
-  **Nikelnero** / Black nickel
-  **Titanium PVD** / Titanium PVD

K 378 Yabu Pushelberg • Fusital

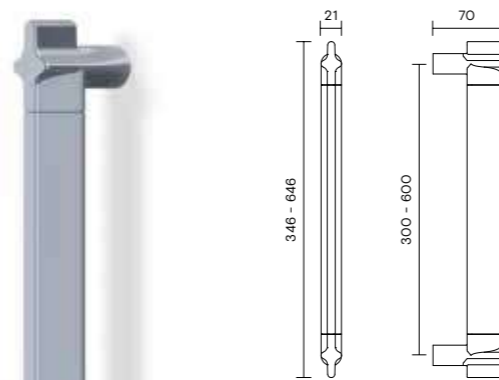
Ottone / Brass







-  **Cromo** / Polished chrome
-  **Bronzo scuro** / Dark bronze
-  **Light black** / Light black

Interasse personalizzabile fino a 2000 mm.
Oltre 1000 mm richiedere applicazione di un piede centrale.
Quantità e prezzi da richiedere.
Centre distance possible on request till 2000 mm. Size over 1000 mm requires application off a third fixing knob.
Quantity and prices to be agreed upon.

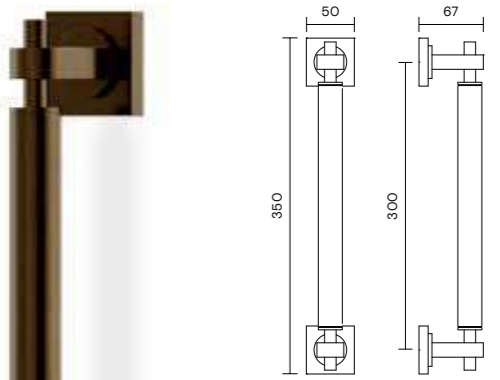
K 377 Steve Leung • Fusital

Ottone / Brass



-  **Bronzo scuro** / Dark bronze
-  **Neropaco** / Matt black
-  **Nikelnero** / Black nickel
-  **Titanium PVD** / Titanium PVD



Interasse personalizzabile fino a 600 mm.
Quantità e prezzi da richiedere.
Centre distance possible on request till 600 mm.
Quantity and prices to be agreed upon.

Maniglioni / Pull handles

K 368 Antonio Citterio • Fusital

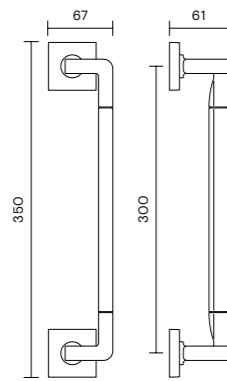
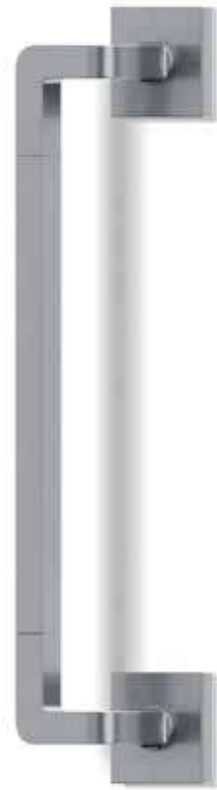
Ottone / Brass





-  Cromo / Polished chrome
-  Cromosat / Satin chrome
-  Light black / Light black

Interasse personalizzabile fino a 600 mm.
Quantità e prezzi da richiedere.
Centre distance possible on request till 600 mm.
Quantity and prices to be agreed upon.

K 358 Cerri & Associati • Fusital

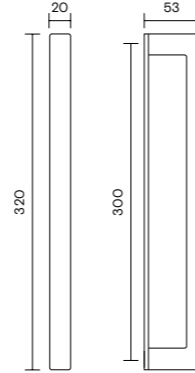
Ottone / Brass



-  Cromo / Polished chrome
-  Cromosat / Satin chrome

Interasse personalizzabile fino a 1200 mm.
Quantità e prezzi da richiedere.
Centre distance possible on request till 1200 mm.
Quantity and prices to be agreed upon.

K 352 Richard Meier • Fusital

Ottone / Brass

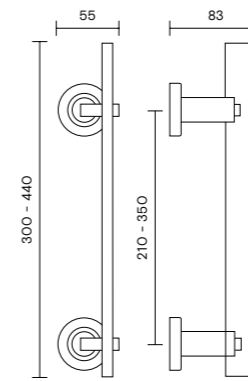



-  Cromo / Polished chrome

Interasse personalizzabile fino a 1200 mm.
Quantità e prezzi da richiedere.
Centre distance possible on request till 1200 mm.
Quantity and prices to be agreed upon.

P 5408 Antonio Citterio • Fusital

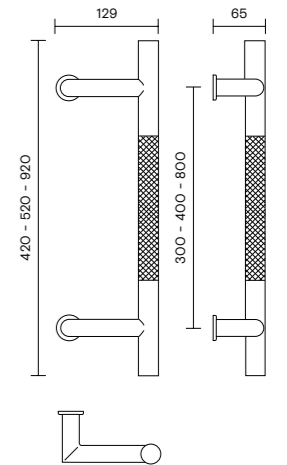
Acciaio inox AISI 316 L / Stainless steel AISI 316 L





-  Acciaio inox satinato / Satin stainless steel
-  Acciaio inox lucido / Polished stainless steel

Interasse personalizzabile fino a 1600 mm.
Quantità e prezzi da richiedere.
Centre distance possible on request till 1600 mm.
Quantity and prices to be agreed upon.

K 356 John Pawson • Fusital

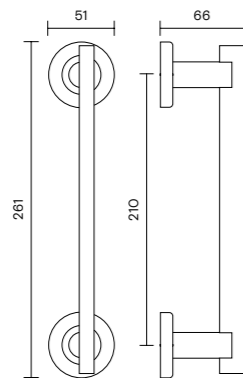
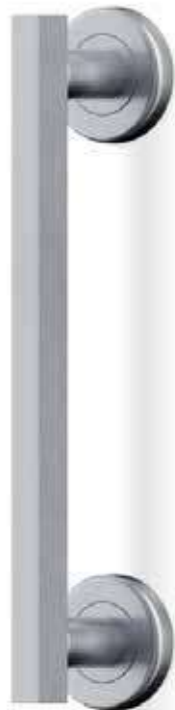
Ottone / Brass





-  Cromo / Polished chrome
-  Cromosat / Satin chrome

Interasse personalizzabile fino a 600 mm.
Quantità e prezzi da richiedere.
Centre distance possible on request till 600 mm.
Quantity and prices to be agreed upon.

K 353 Taller Design Ricardo Bofill • Fusital

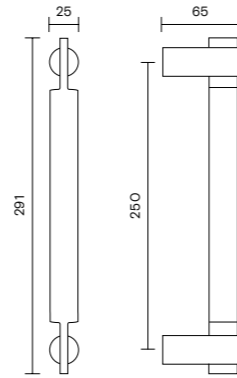
Ottone / Brass





-  Cromo / Cromosat
Polished chrome / Satin chrome
-  Orolucido / Orsatin
Polished brass / Satin brass

Interasse personalizzabile fino a 1200 mm.
Quantità e prezzi da richiedere.
Centre distance possible on request till 1200 mm.
Quantity and prices to be agreed upon.

P 5406 Antonio Citterio • Fusital

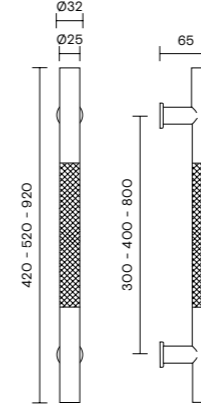
Acciaio inox AISI 316 L / Stainless steel AISI 316 L





-  Acciaio inox satinato / Satin stainless steel
-  Acciaio inox lucido / Polished stainless steel

Interasse personalizzabile fino a 2000 mm.
Quantità e prezzi da richiedere.
Centre distance possible on request till 2000 mm.
Quantity and prices to be agreed upon.

P 5405 Taller Design Ricardo Bofill • Fusital

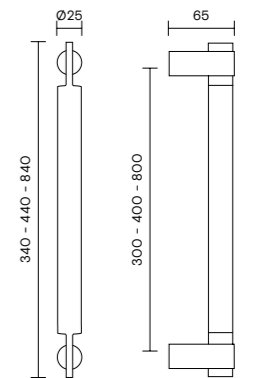
Acciaio inox AISI 316 L / Stainless steel AISI 316 L



-  Acciaio inox satinato / Satin stainless steel
-  Acciaio inox lucido / Polished stainless steel



Interasse personalizzabile fino a 2000 mm.
Quantità e prezzi da richiedere.
Centre distance possible on request till 2000 mm.
Quantity and prices to be agreed upon.

Maniglioni / Pull handles

K 1235 - Lab

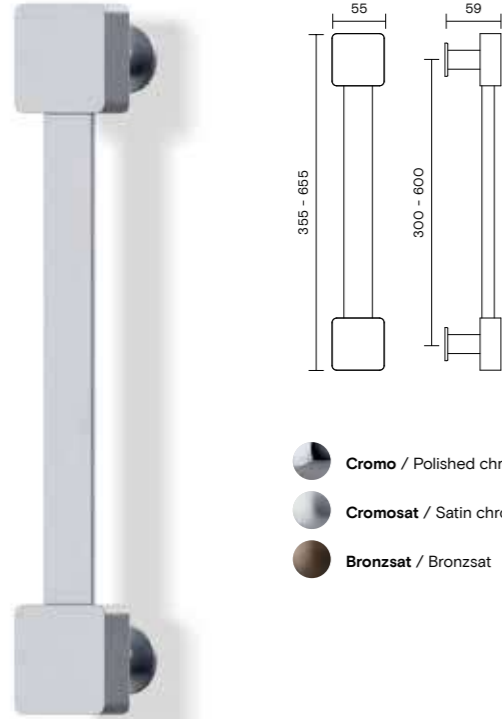
Alluminio / Aluminium





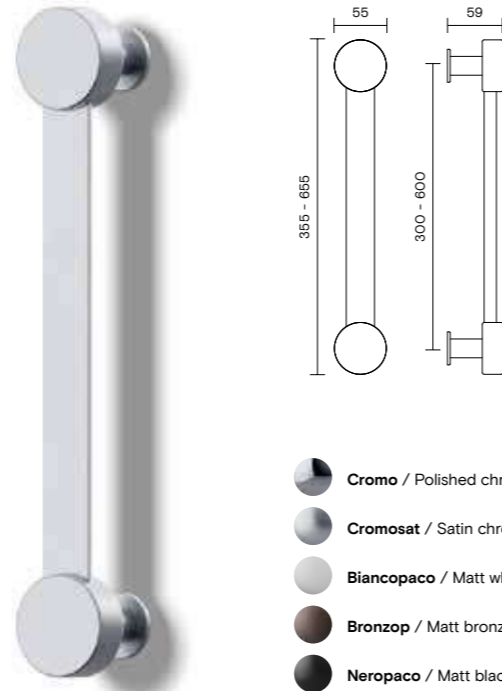

-  **Cromo** / Polished chrome
-  **Cromosat** / Satin chrome
-  **Bronzsat** / Bronzsat

K 1231 - Lab

Alluminio / Aluminium



-  **Cromo** / Polished chrome
-  **Cromosat** / Satin chrome
-  **Biancopaco** / Matt white
-  **Bronzop** / Matt bronze
-  **Neropaco** / Matt black

K 1224 - Lab

Acciaio inox AISI 304 / Stainless steel AISI 304

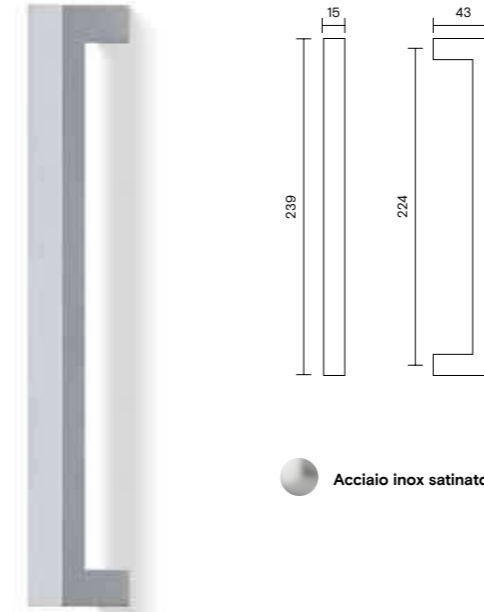

-  **Acciaio inox satinato** / Satin stainless steel

K 1219 - Lab

Acciaio inox AISI 316 L / Stainless steel AISI 316 L

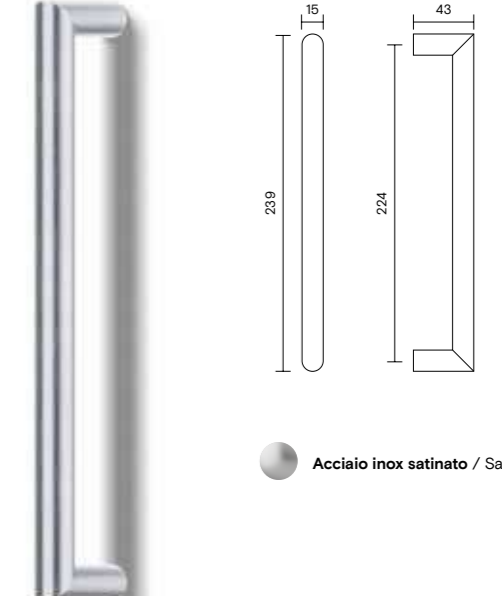

-  **Acciaio inox satinato** / Satin stainless steel

K 1228 Yashimi Kono - Fusital

Ottone / Brass

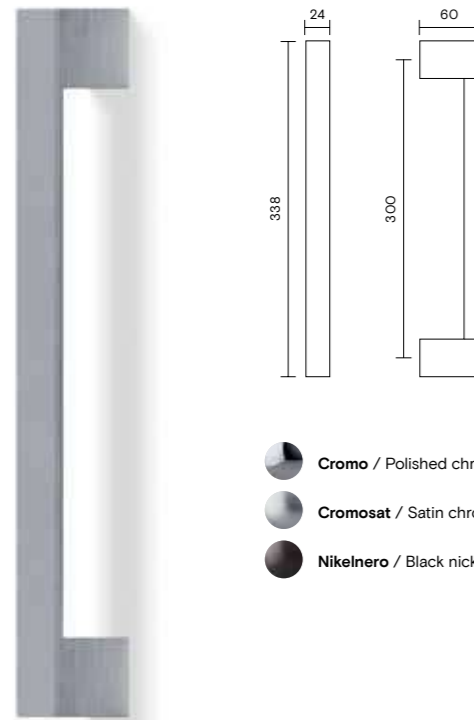



-  **Cromo** / Polished chrome
-  **Cromosat** / Satin chrome
-  **Nikelnero** / Black nickel

K 1226 Jean-Baptiste Sibertin Blanc - Fusital

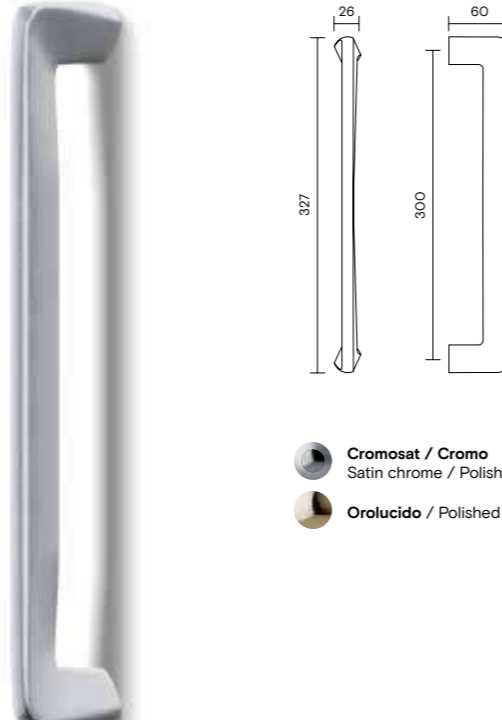
Ottone / Brass





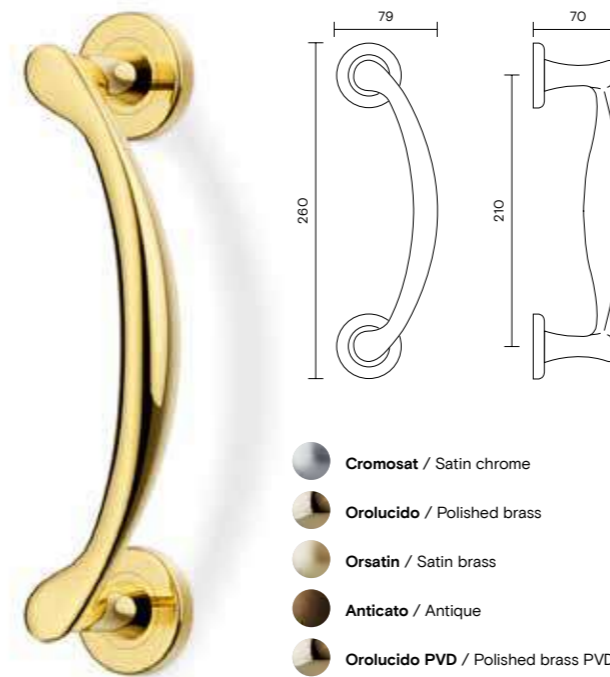

-  **Cromosat / Cromo**
Satin chrome / Polished chrome
-  **Orolucido** / Polished brass

K 1210 Eero Aarnio - Fusital

Ottone / Brass





-  **Cromosat** / Satin chrome
-  **Orolucido** / Polished brass
-  **Orsatin** / Satin brass
-  **Anticato** / Antique
-  **Orolucido PVD** / Polished brass PVD

K 1188 - Lab

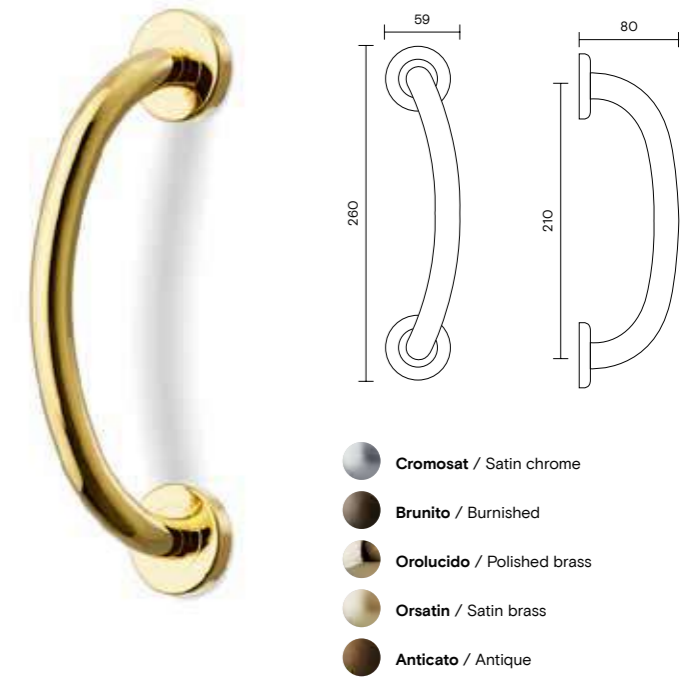
Ottone / Brass







-  **Cromosat** / Satin chrome
-  **Brunito** / Burnished
-  **Orolucido** / Polished brass
-  **Orsatin** / Satin brass
-  **Anticato** / Antique

Maniglioni / Pull handles

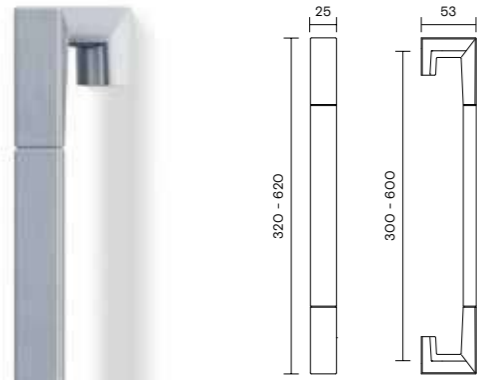
K 1068 Pembroke & Ives • Fusital

Ottone / Brass





-  **Cromo** / Polished chrome
-  **Cromosat** / Satin chrome
-  **Cromo / Cromosat**
Polished chrome / Satin chrome

K 1067 Rose • Lab

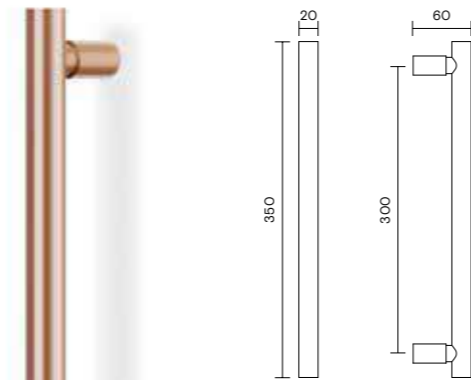
Rame / Copper



-  **Metallo rame lucido** / Polished pure copper
-  **Metallo rame satinato** / Satin pure copper

K 1054 W.W. • Lab

Alluminio / Aluminium

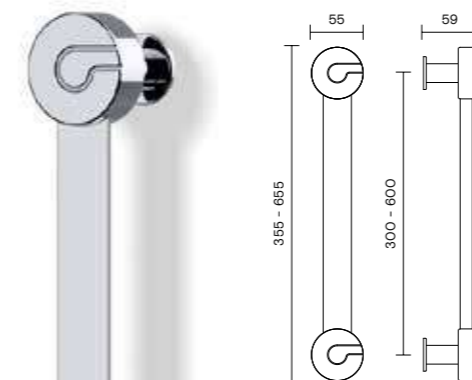

-  **Cromo** / Polished chrome
-  **Nikmatt** / Nikmatt
-  **Orsatop** / Matt brass

K 466 • Lab

Acciaio inox AISI 304 / Stainless steel AISI 304

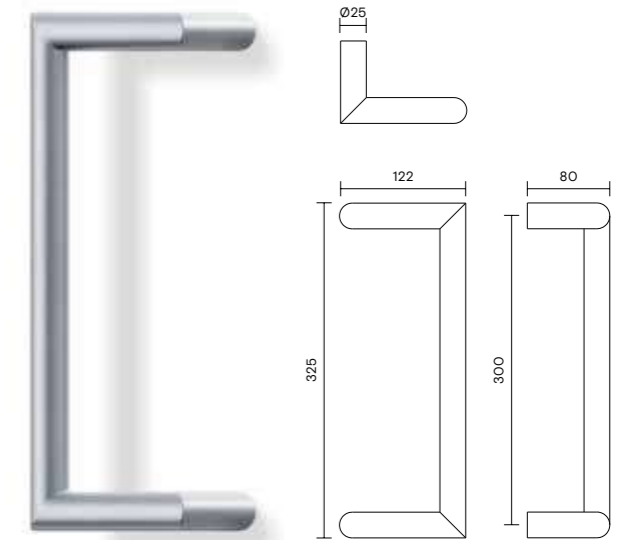



-  **Acciaio inox satinato** / Satin stainless steel

K 1061 Di Virgilio Veneziano • Fusital

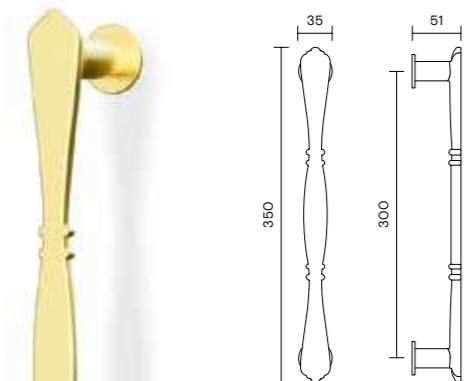
Ottone / Brass



-  **Bronzop** / Matt bronze
-  **Light black** / Light black
-  **Orsatin** / Satin brass

K 1056 • Lab

Alluminio / Aluminium

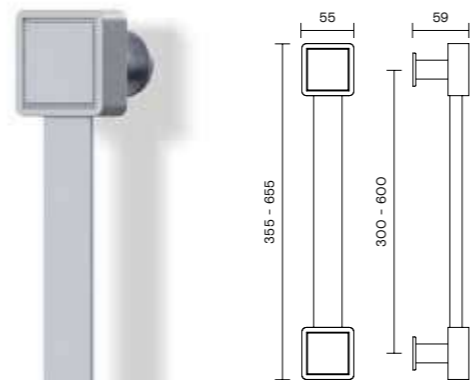

-  **Cromo** / Polished chrome
-  **Neropaco** / Matt black
-  **Nikelnero** / Black nickel

K 464 • Lab

Acciaio inox AISI 304 / Stainless steel AISI 304

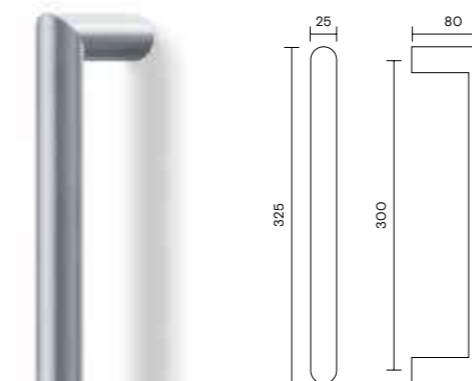

-  **Acciaio inox satinato** / Satin stainless steel

Alzanti scorrevoli / Lift and slide handles

K 169 Yoshimi Kono • Fusital

Ottone / Brass

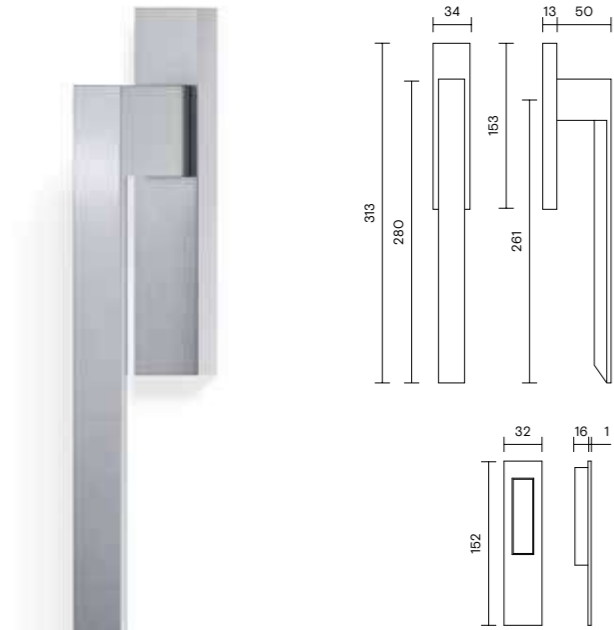







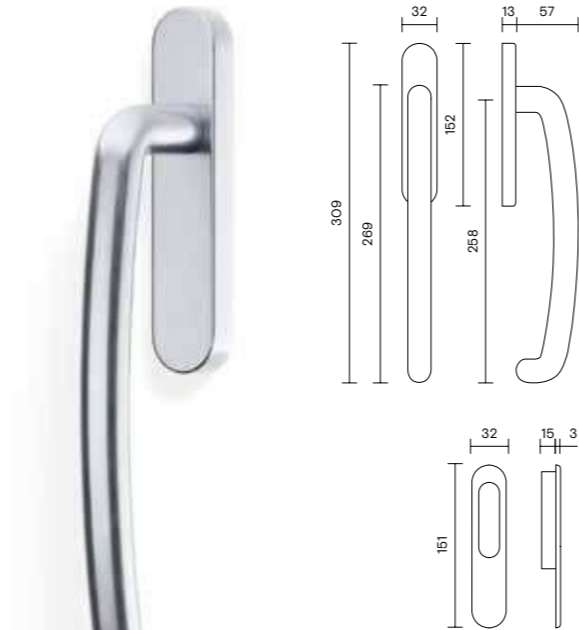

-  **Cromo** / Polished chrome
-  **Cromosat** / Satin chrome
-  **Cromosat / Cromo**
Satin chrome / Polished chrome
-  **Biancopaco** / Matt white
-  **Bronzop** / Matt bronze
-  **Light black** / Light black
-  **Neropaco** / Matt black
-  **Nikelnero** / Black nickel
-  **Nikmatt** / Nikmatt

K 163 Sarissa • Lab

Ottone / Brass





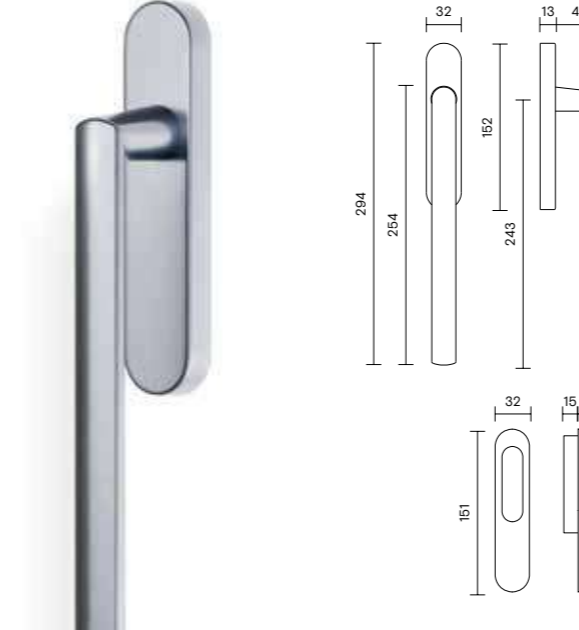

-  **Cromo** / Polished chrome
-  **Cromosat** / Satin chrome
-  **Biancopaco** / Matt white
-  **Bronzop** / Matt bronze
-  **Brunito** / Burnished
-  **Nikelnero** / Black nickel
-  **Orolucido** / Polished brass
-  **Ottone naturale** / Natural brass

K 411 • Lab

Ottone / Brass





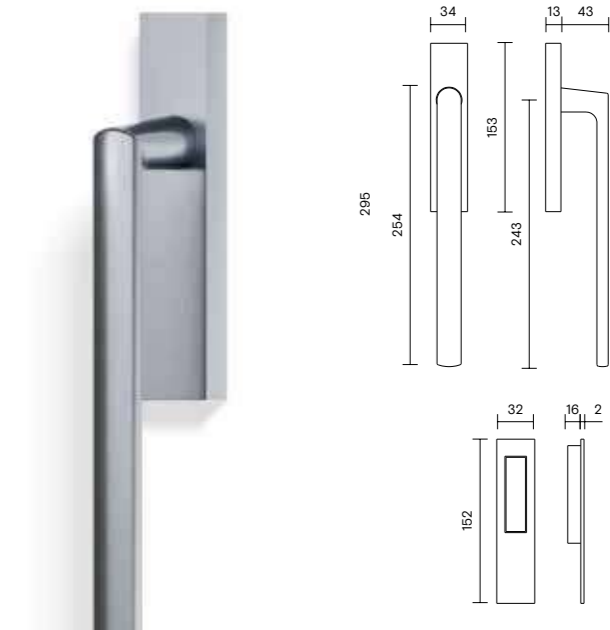

-  **Cromo** / Polished chrome
-  **Cromosat** / Satin chrome
-  **Biancopaco** / Matt white
-  **Neropaco** / Matt black

K 411 Q • Lab

Ottone / Brass



-  **Cromo** / Polished chrome
-  **Cromosat** / Satin chrome
-  **Biancopaco** / Matt white
-  **Neropaco** / Matt black

Bocchette / Escutcheons

K 1755 CP · Lab

Ottone / Brass



K 1755 CP



K 1755 CP Y

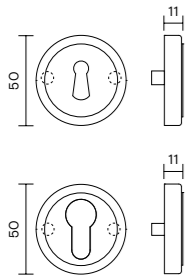

- Anticato**
Antique
- Orlucido**
Polished brass
- Ottone antico**
Antique brass
- Brunito**
Burnished
- Orsatin**
Satin brass

K 1713 CP · Lab

Ottone / Brass



K 1713 CP



K 1713 CP Y

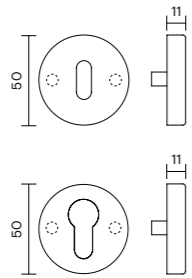

- Cromo**
Polished chrome
- Cromosat**
Satin chrome
- Anticato**
Antique
- Biancopaco**
Matt white
- Bronzop**
Matt bronze
- Bronzsat**
Bronzsat
- Bronzo scuro**
Dark bronze
- Light black**
Light black
- Neropaco**
Matt black
- Nikmatt**
Nikmatt
- Orlucido**
Polished brass
- Orlucido PVD**
Polished brass PVD
- Orsatin**
Satin brass
- Orsatop**
Matt brass

K 1713 CP B · Lab

Ottone / Brass



K 1713 CP B



K 1713 CP B Y

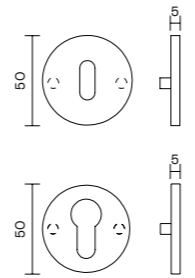

- Cromo**
Polished chrome
- Cromosat**
Satin chrome
- Anticato**
Antique
- Biancopaco**
Matt white
- Bronzop**
Matt bronze
- Bronzsat**
Bronzsat
- Bronzo scuro**
Dark bronze
- Light black**
Light black
- Neropaco**
Matt black
- Nikmatt**
Nikmatt
- Orlucido**
Polished brass
- Orlucido PVD**
Polished brass PVD
- Orsatin**
Satin brass
- Orsatop**
Matt brass

K 1144 CP · Lab

Nikrall Lega Zama
UNI 3717



K 1144 CP



K 1144 CP Y

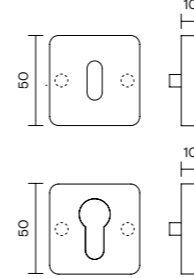

- Cromo**
Polished chrome
- Cromosat**
Satin chrome
- Light black**
Light black
- Neropaco**
Matt black

K 1144 · Lab

Nikrall Lega Zama
UNI 3717



K 1144



K 1144 Y

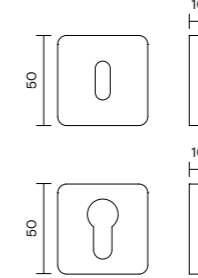

- Cromo**
Polished chrome
- Cromosat**
Satin chrome
- Light black**
Light black
- Neropaco**
Matt black

K 1143 · Lab

Nikrall Lega Zama
UNI 3717



K 1143



K 1143 Y

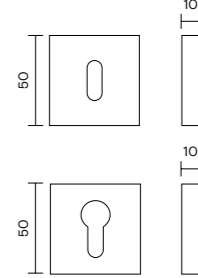

- Cromo**
Polished chrome
- Cromosat**
Satin chrome
- Bronzo scuro**
Dark bronze
- Bronzsat**
Bronzsat
- Brunito**
Burnished
- Neropaco**
Matt black
- Nikelnero**
Black nickel
- Orlucido**
Polished brass
- Titanium PVD**
Titanium PVD

K 1197 · Lab

Rame / Copper



K 1197



K 1197 Y

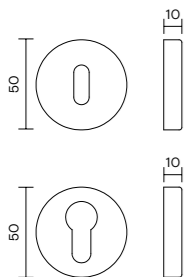

- Metallo rame lucido**
Polished pure copper
- Metallo rame satinato**
Satin pure copper

K 1148 · Lab

Ottone / Brass



K 1148



K 1148 Y

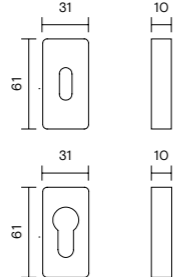

- Cromo**
Polished chrome
- Cromosat**
Satin chrome
- Bronzop**
Matt bronze
- Bronzsat**
Bronzsat
- Bronzo scuro**
Dark bronze
- Brunito**
Burnished
- Light black**
Light black
- Neropaco**
Matt black
- Nikelnero**
Black nickel
- Orlucido**
Polished brass
- Orsatop**
Matt brass

K 1145 · Lab

Ottone / Brass



K 1145



K 1145 Y

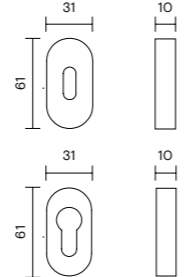

- Cromo**
Polished chrome
- Cromosat**
Satin chrome
- Anticato**
Antique
- Biancopaco**
Matt white
- Bronzop**
Matt bronze
- Bronzsat**
Bronzsat
- Brunito**
Burnished
- Neropaco**
Matt black
- Nikelnero**
Black nickel
- Nikmatt**
Nikmatt
- Orlucido**
Polished brass
- Orlucido PVD**
Polished brass PVD
- Orsatin**
Satin brass
- Orsatop**
Matt brass
- Ottone antico**
Antique brass
- Ottone naturale**
Natural brass

K 1143 B · Lab

Ottone / Brass



K 1143 B

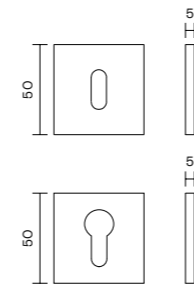

- Cromo**
Polished chrome
- Cromosat**
Satin chrome
- Bronzo scuro**
Dark bronze
- Bronzsat**
Bronzsat
- Brunito**
Burnished
- Neropaco**
Matt black
- Nikelnero**
Black nickel
- Orlucido**
Polished brass
- Titanium PVD**
Titanium PVD

K 1143 CP · Lab

Nikrall Lega Zama
UNI 3717



K 1143 CP



K 1143 CP Y

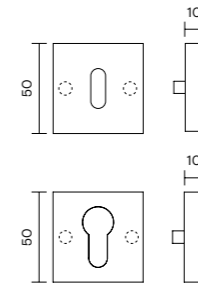

- Cromo**
Polished chrome
- Cromosat**
Satin chrome
- Bronzo scuro**
Dark bronze
- Bronzsat**
Bronzsat
- Brunito**
Burnished
- Neropaco**
Matt black
- Nikelnero**
Black nickel
- Orlucido**
Polished brass
- Titanium PVD**
Titanium PVD

K 1143 CP B · Lab

Ottone / Brass



K 1143 CP B



K 1143 CP B Y

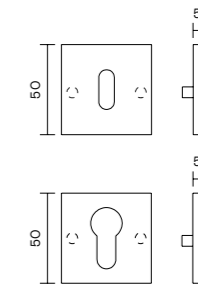

- Cromo**
Polished chrome
- Cromosat**
Satin chrome
- Bronzo scuro**
Dark bronze
- Light black**
Light black
- Neropaco**
Matt black
- Nikelnero**
Black nickel
- Orlucido**
Polished brass
- Titanium PVD**
Titanium PVD

Bocchette / Escutcheons

K 1142 - Lab

Nikrall Lega Zama
UNI 3717



K 1142



K 1142 Y

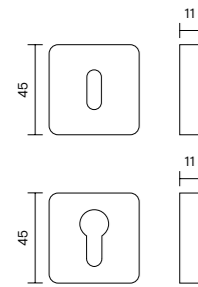

- Cromo
Polished chrome
- Cromosat
Satin chrome
- Light black
Light black
- Neropaco
Matt black

K 1139 - Lab

Nikrall Lega Zama
UNI 3717



K 1139



K 1139 Y

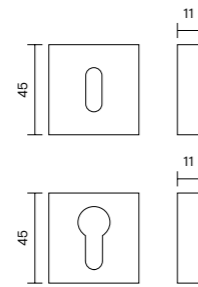

- Cromo
Polished chrome
- Cromosat
Satin chrome
- Neropaco
Matt black

K 1132 - Lab

Ottone / Brass



K 1132

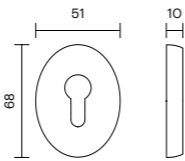

- Cromosat
Satin chrome
- Orolucido
Polished brass

K 1112 - Lab

Brass / Ottone



K 1112



K 1112 Y

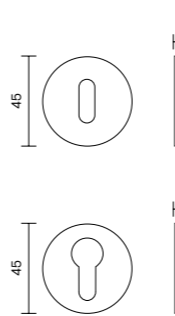

- Cromo
Polished chrome
- Cromosat
Satin chrome
- Anticato
Antique
- Biancopaco
Matt white
- Bronzop
Matt bronze
- Brunito
Burnished
- Nikelnero
Black nickel
- Orolucido
Polished brass
- Orolucido PVD
Polished brass PVD
- Orsatin
Satin brass
- Orsatop
Matt brass
- Ottone naturale
Natural brass

K 1110 - Lab

Brass / Ottone



K 1110



K 1110 Y

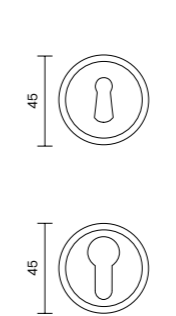

- Anticato
Antique
- Brunito
Burnished
- Orolucido
Polished br
- Orsatin
Satin brass
- Ottone ant
Antique br
- Ottone naturale
Natural bra:

R 5154 R - Fusital

Acciaio inox AISI 316 L
Stainless steel AISI 316 L



R 5154 R N



R 5154 R Y



R 5154 R CO



R 5154 R K



R 5154 R SFC

- Acciaio inox satinato
Satin stainless steel
- Acciaio inox lucido
Polished stainless steel

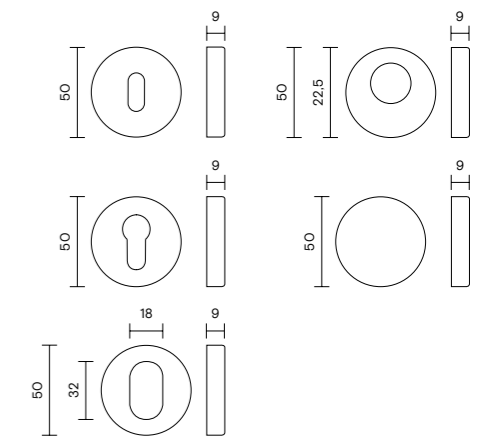

K 1122 - Lab

Ottone / Brass



K 1122



K 1122 Y

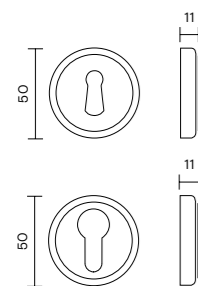

- Cromo
Polished chrome
- Bronzop
Matt bronze
- Orolucido
Polished brass

K 1121 - Lab

Ottone / Brass



K 1121



K 1121 Y

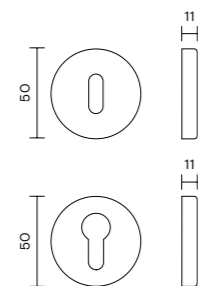

- Cromo
Polished chrome
- Cromosat
Satin chrome
- Anticato
Antique
- Biancopaco
Matt white
- Bronzop
Matt bronze
- Bronzo scuro
Dark bronze
- Bronzsat
Bronzsat
- Light black
Light black
- Neropaco
Matt black
- Nikelnero
Black nickel
- Nikmatt
Nikmatt
- Orolucido
Polished brass
- Orsatin
Satin brass
- Orsatop
Matt brass

K 1121 B - Lab

Ottone / Brass



K 1121 B



K 1121 B Y

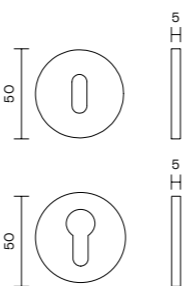

- Cromo
Polished chrome
- Cromosat
Satin chrome
- Biancopaco
Matt white
- Bronzop
Matt bronze
- Bronzo scuro
Dark bronze
- Bronzsat
Bronzsat
- Light black
Light black
- Neropaco
Matt black
- Nikelnero
Black nickel
- Nikmatt
Nikmatt
- Orolucido
Polished brass
- Orsatin
Satin brass
- Orsatop
Matt brass

K 195 - Lab

Ottone / Brass



K 195



K 195 Y

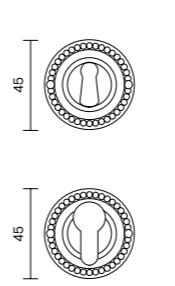

- Orolucido
Polished brass
- Ottone antico
Antique brass

R 5154 RG - Fusital

Acciaio inox AISI 316 L
Stainless steel AISI 316 L



R 5154 RG N



R 5154 RG Y

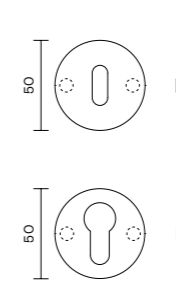

- Acciaio inox satinato
Satin stainless steel
- Acciaio inox lucido
Polished stainless steel

Bocchette / Escutcheons

K 5145 • Fusital

Acciaio inox AISI 316 L
Stainless steel AISI 316 L



K 5145



K 5145 Y

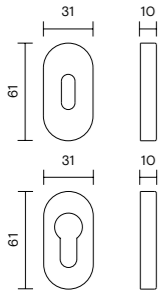

- **Acciaio inox satinato**
Satin stainless steel
- **Acciaio inox lucido**
Polished stainless steel

K 49 • Lab

Acciaio inox AISI 304
Stainless steel AISI 304



K 49



K 49 Y

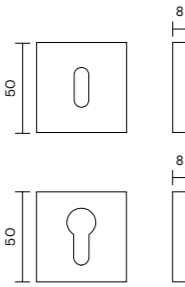

K 48 • Lab

Acciaio inox AISI 304
Stainless steel AISI 304



K 48



K 48 Y

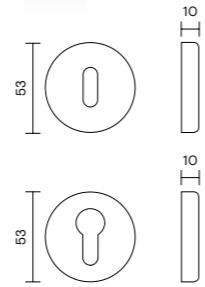

- **Acciaio inox satinato**
Satin stainless steel

K 48 OV • Lab

Acciaio inox AISI 304
Stainless steel AISI 304



K 48 OV



K 48 OV Y

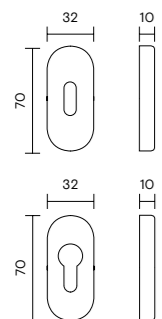

- **Acciaio inox satinato**
Satin stainless steel

R 5148 • Lab

Acciaio inox AISI 304
Stainless steel AISI 304



K 5148 N



K 5148 Y

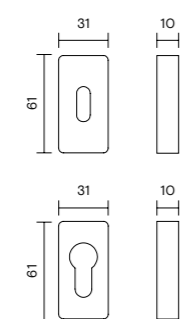

- **Acciaio inox satinato**
Satin stainless steel

K 1136 PL • Lab

Ottone / Brass

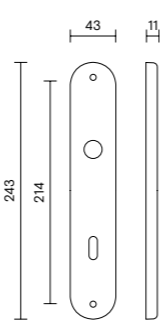

K 1136 PL 70
K 1136 PL 90

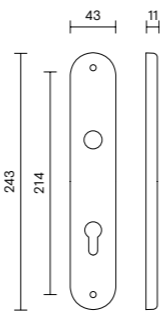

K 1136 PL Y 85

- **Cromo**
Polished chrome
- **Cromosat**
Satin chrome
- **Anticato**
Antique
- **Brunito**
Burnished
- **Orolucido**
Polished brass
- **Orsatin**
Satin brass
- **Ottone naturale**
Natural brass

K 1136 PL Y 85

Maniglie per incasso / Inset handles

K 3014 Antonio Citterio - Toan Nguyen • Fusital

Ottone / Brass

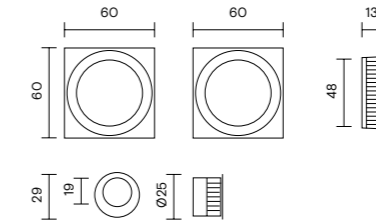
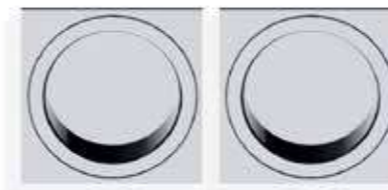

- **Cromo**
Polished chrome
- **Cromosat**
Satin chrome
- **Bronzop**
Matt bronze
- **Orsatop**
Matt brass

K 3012 Antonio Citterio - Toan Nguyen • Fusital

Ottone / Brass

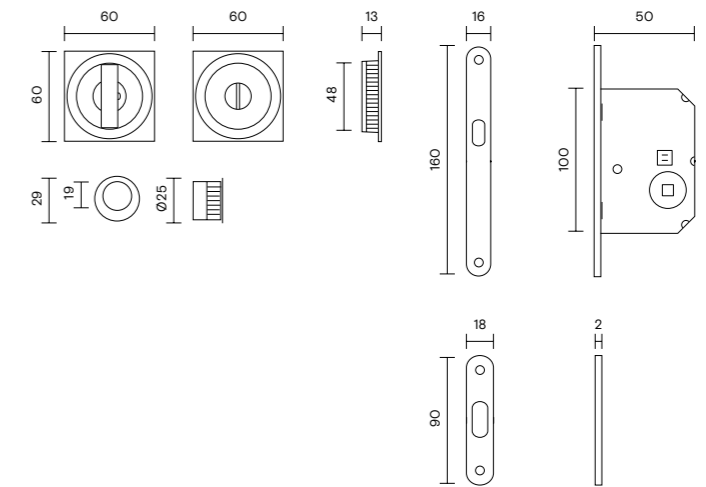

- **Cromo**
Polished chrome
- **Cromosat**
Satin chrome
- **Bronzop**
Matt bronze
- **Orsatop**
Matt brass

K 4200 • Lab

Ottone / Brass

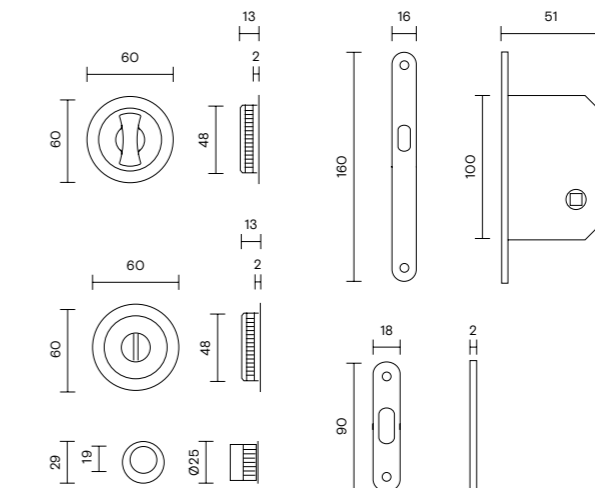

- **Cromo**
Polished chrome
- **Cromosat**
Satin chrome
- **Orolucido**
Polished brass

Maniglie per incasso / Inset handles

K 1232 Yoshimi Kono • Fusital

Ottone / Brass



- Cromo**
Polished chrome
- Cromosat**
Satin chrome
- Nikelnero**
Black nickel
- Neropaco**
Matt black

K 1215 • Lab

Nikrall Lega Zama UNI 3717

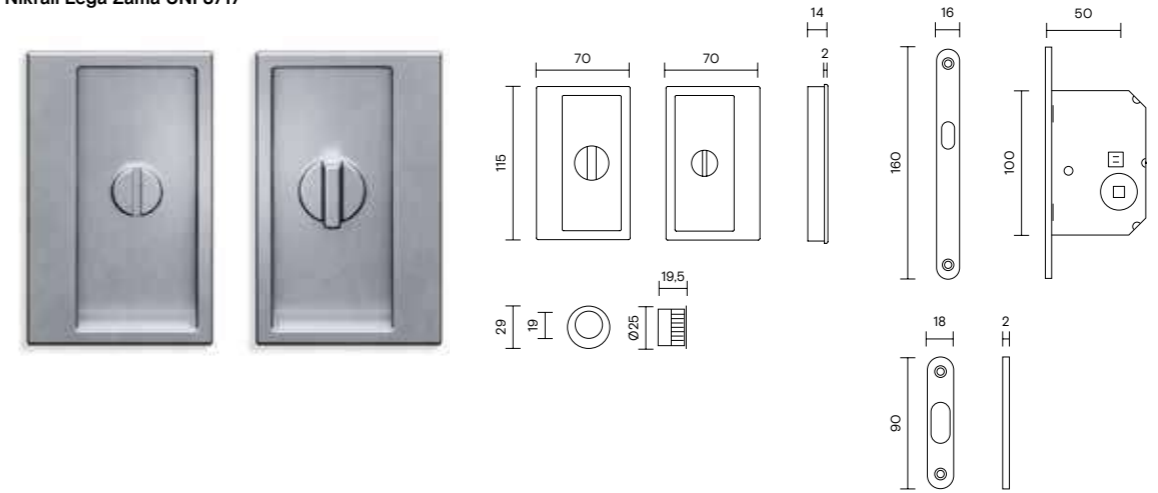

- Cromo**
Polished chrome
- Cromosat**
Satin chrome
- Bronzo scuro**
Dark bronze
- Bronzsat**
Satin bronze
- Light black**
Light black
- Neropaco**
Matt black
- Nikelnero**
Black nickel
- Nikmatt**
Nikmatt

K 1230 Yoshimi Kono • Fusital

Ottone / Brass

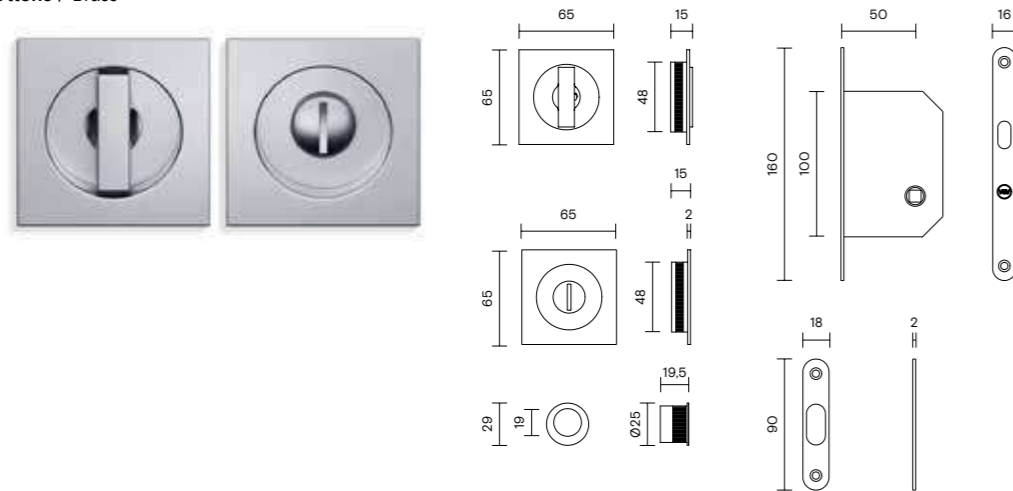

- Cromo**
Polished chrome
- Cromosat**
Satin chrome
- Nikelnero**
Black nickel

K 1212 • Lab

Ottone / Brass

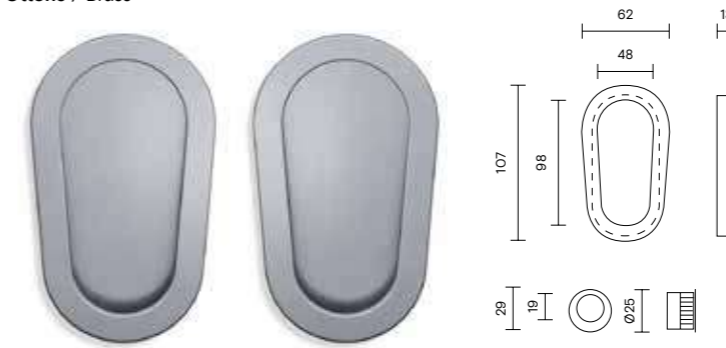

- Cromo**
Polished chrome
- Cromosat**
Satin chrome
- Bronzo scuro**
Dark bronze
- Bronzsat**
Satin bronze
- Light black**
Light black
- Neropaco**
Matt black
- Nikelnero**
Black nickel
- Nikmatt**
Nikmatt
- Orolucido**
Polished brass

K 1215 SFC • Lab

Nikrall Lega Zama UNI 3717

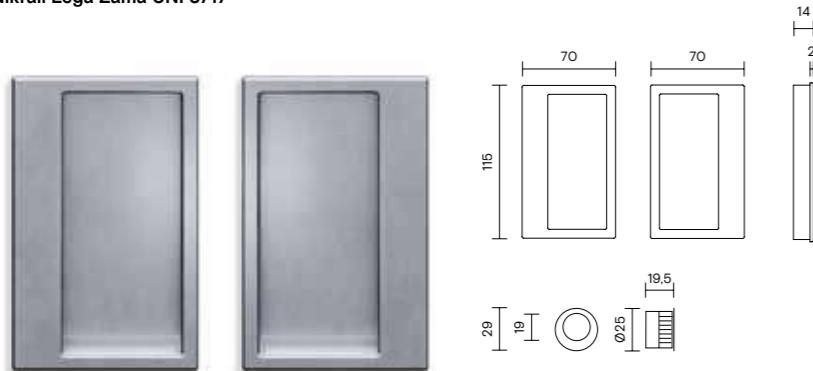

- Cromo**
Polished chrome
- Cromosat**
Satin chrome
- Bronzo scuro**
Dark bronze
- Bronzsat**
Satin bronze
- Light black**
Light black
- Neropaco**
Matt black
- Nikelnero**
Black nickel
- Nikmatt**
Nikmatt

K 1211 • Lab

Ottone / Brass

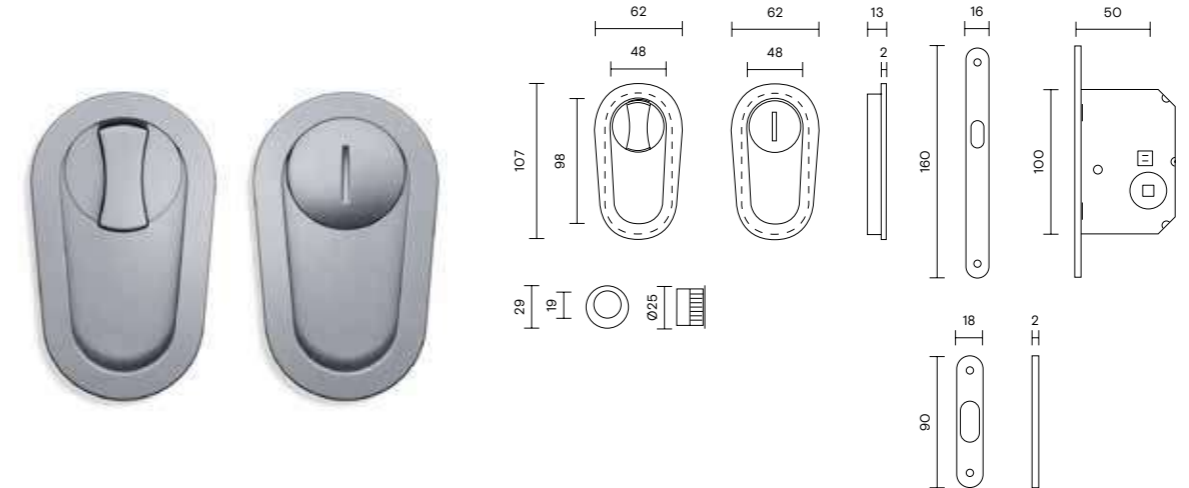

- Cromo**
Polished chrome
- Cromosat**
Satin chrome
- Bronzo scuro**
Dark bronze
- Bronzsat**
Satin bronze
- Light black**
Light black
- Neropaco**
Matt black
- Nikelnero**
Black nickel
- Nikmatt**
Nikmatt
- Orolucido**
Polished brass

Maniglie per incasso / Inset handles

K 1206 • Lab

Ottone / Brass

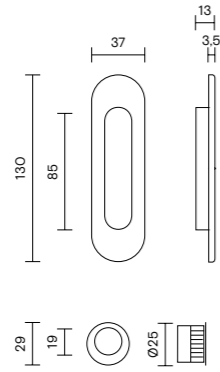







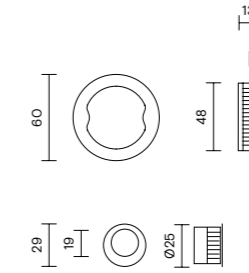

-  **Cromo**
Polished chrome
-  **Cromosat**
Satin chrome
-  **Anticato**
Antique
-  **Neropaco**
Matt black
-  **Orolucido**
Polished brass
-  **Orsatin**
Satin brass

K 1202 • Lab

Ottone / Brass



-  **Cromo**
Polished chrome
-  **Cromosat**
Satin chrome
-  **Anticato**
Antique
-  **Biancopaco**
Matt white
-  **Bronzop**
Matt bronze
-  **Brunito**
Burnished
-  **Nikelnero**
Black nickel
-  **Orolucido**
Polished brass
-  **Orsatin**
Satin brass
-  **Ottone naturale**
Satin bronze

K 1204 • Lab

Ottone / Brass

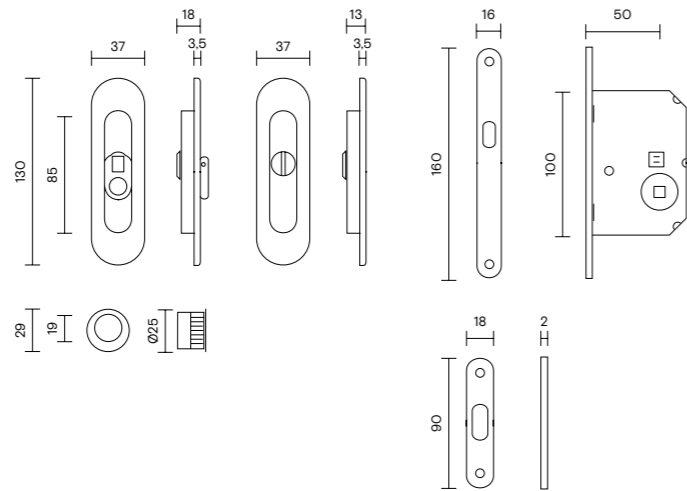





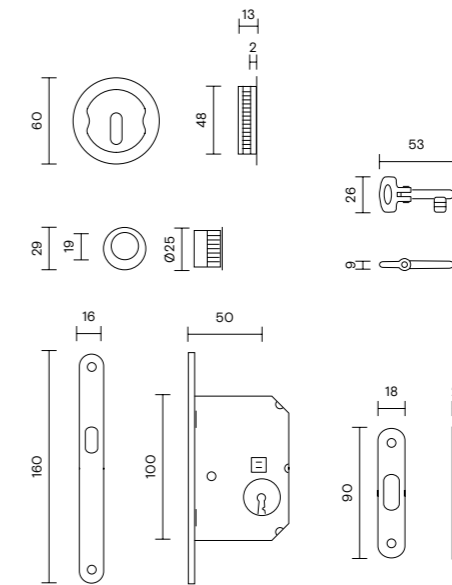

-  **Cromo**
Polished chrome
-  **Cromosat**
Satin chrome
-  **Anticato**
Antique
-  **Neropaco**
Matt black
-  **Orolucido**
Polished brass
-  **Orsatin**
Satin brass

K 1201 • Lab

Ottone / Brass





-  **Cromo**
Polished chrome
-  **Cromosat**
Satin chrome
-  **Anticato**
Antique
-  **Biancopaco**
Matt white
-  **Bronzop**
Matt bronze
-  **Brunito**
Burnished
-  **Neropaco**
Matt black
-  **Nikelnero**
Black nickel
-  **Nikmatt**
Nikmatt
-  **Orolucido**
Polished brass
-  **Orsatin**
Satin brass
-  **Ottone naturale**
Satin bronze

K 1203 • Lab

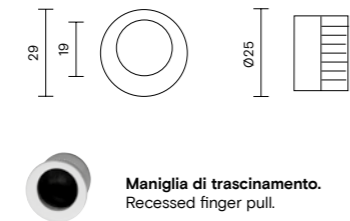
Ottone / Brass



Maniglia di trascinamento.
Recessed finger pull.

-  **Cromo**
Polished chrome
-  **Cromosat**
Satin chrome
-  **Anticato**
Antique
-  **Biancopaco**
Matt white
-  **Bronzop**
Matt bronze
-  **Neropaco**
Matt black
-  **Nikelnero**
Black nickel
-  **Nikmatt**
Nikmatt
-  **Orolucido**
Polished brass
-  **Orsatin**
Satin brass
-  **Ottone naturale**
Satin bronze

K 1200 • Lab

Ottone / Brass

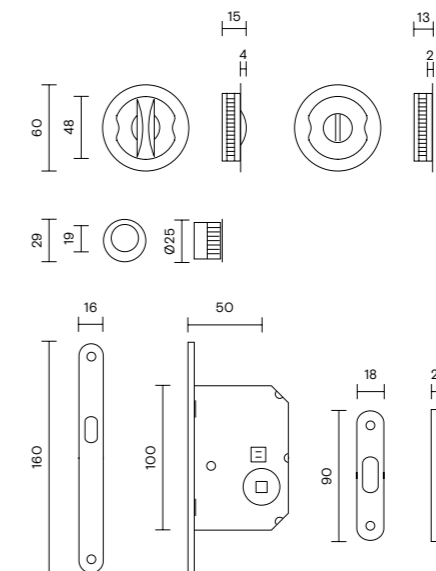

-  **Cromo**
Polished chrome
-  **Cromosat**
Satin chrome
-  **Anticato**
Antique
-  **Biancopaco**
Matt white
-  **Bronzop**
Matt bronze
-  **Brunito**
Burnished
-  **Light black**
Light black
-  **Neropaco**
Matt black
-  **Nikelnero**
Black nickel
-  **Orolucido**
Polished brass
-  **Orsatin**
Satin brass
-  **Ottone naturale**
Satin bronze

Maniglie per incasso / Inset handles

K 1186 • Lab

Ottone / Brass

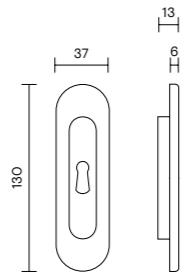

- | | |
|------------------------------------|--|
| Cromo
Polished chrome | Neropaco
Matt black |
| Cromosat
Satin chrome | Nikmatt
Nikmatt |
| Anticato
Antique | Orolucido
Polished brass |
| Bronzo scuro
Dark bronze | Orsatin
Satin brass |
| Brunito
Burnished | Ottone naturale
Satin bronze |

K 1198 SFC • Lab

Ottone / Brass

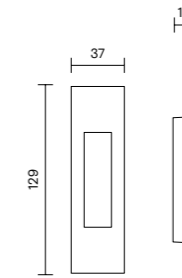

- | | |
|------------------------------------|--|
| Cromo
Polished chrome | Neropaco
Matt black |
| Cromosat
Satin chrome | Nikmatt
Nikmatt |
| Anticato
Antique | Orolucido
Polished brass |
| Bronzo scuro
Dark bronze | Orsatin
Satin brass |
| Brunito
Burnished | Ottone naturale
Satin bronze |

K 1186 SFC • Lab

Ottone / Brass

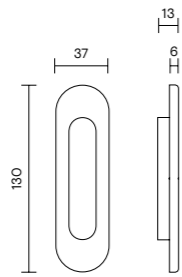

- | | |
|------------------------------------|--|
| Cromo
Polished chrome | Neropaco
Matt black |
| Cromosat
Satin chrome | Nikmatt
Nikmatt |
| Anticato
Antique | Orolucido
Polished brass |
| Bronzo scuro
Dark bronze | Orsatin
Satin brass |
| Brunito
Burnished | Ottone naturale
Satin bronze |

K 4202 • Lab

Ottone / Brass

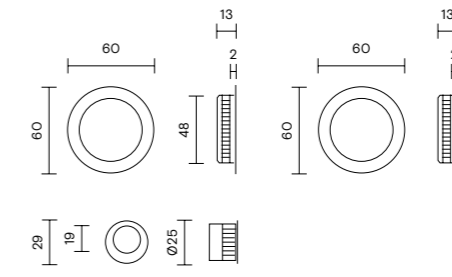

- | | |
|------------------------------------|--|
| Cromo
Polished chrome | Neropaco
Matt black |
| Cromosat
Satin chrome | Nikmatt
Nikmatt |
| Anticato
Antique | Orolucido
Polished brass |
| Bronzo scuro
Dark bronze | Orsatin
Satin brass |
| Brunito
Burnished | Ottone naturale
Satin bronze |

K 1195 • Lab

Ottone / Brass

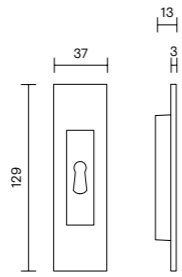

- | | |
|------------------------------------|--|
| Cromo
Polished chrome | Neropaco
Matt black |
| Cromosat
Satin chrome | Nikmatt
Nikmatt |
| Anticato
Antique | Orolucido
Polished brass |
| Bronzo scuro
Dark bronze | Orsatin
Satin brass |
| Brunito
Burnished | Ottone naturale
Satin bronze |

Chiusure privacy BZG / Bathroom privacy sets

K 3041 Joe Cheng • Fusital

Ottone / Brass

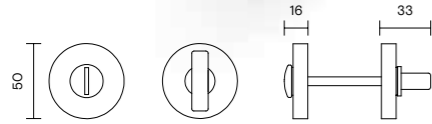

-  **Bronzop**
Matt bronze
-  **Orantop**
Antique matte gold
-  **Tortora**
Dove grey

K 3041 RB Joe Cheng • Fusital

Ottone / Brass

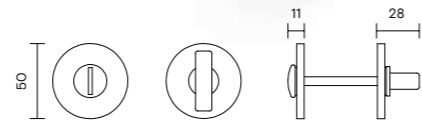





-  **Bronzop**
Matt bronze
-  **Orantop**
Antique matte gold
-  **Tortora**
Dove grey

Ottone / Brass

K 3040 RB Khalid Al Najjar • Fusital

Ottone / Brass





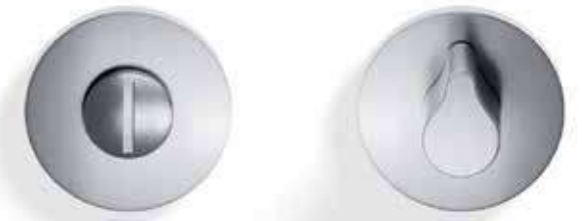

-  **Cromosat**
Satin chrome
-  **Nikelnero**
Black nickel
-  **Orsatop**
Matt brass
-  **Titanium PVD**
Titanium PVD

K 3040 RG Khalid Al Najjar • Fusital

Ottone / Brass



-  **Cromosat**
Satin chrome
-  **Nikelnero**
Black nickel
-  **Orsatop**
Matt brass
-  **Titanium PVD**
Titanium PVD

K 3041 RG Joe Cheng • Fusital

Ottone / Brass

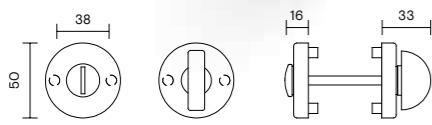



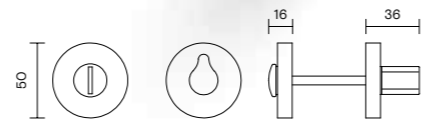

-  **Bronzop**
Matt bronze
-  **Orantop**
Antique matte gold
-  **Tortora**
Dove grey

K 3040 Khalid Al Najjar • Fusital

Ottone / Brass



-  **Cromosat**
Satin chrome
-  **Nikelnero**
Black nickel
-  **Orsatop**
Matt brass
-  **Titanium PVD**
Titanium PVD

K 3029 50 • Lab

Ottone / Brass



-  **Cromo**
Polished chrome
-  **Cromosat**
Satin chrome
-  **Light black**
Light black
-  **Neropaco**
Matt black

K 3029 50 RS • Lab

Brass / Ottone

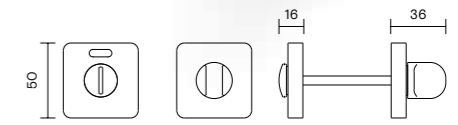

-  **Cromo**
Polished chrome
-  **Cromosat**
Satin chrome
-  **Light black**
Light black
-  **Neropaco**
Matt black

Chiusure privacy BZG / Bathroom privacy sets

K 3029 RG · Lab

Ottone / Brass

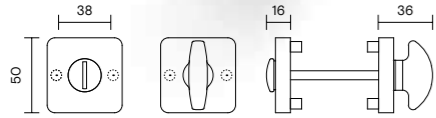

-  **Cromo**
Polished chrome
-  **Cromosat**
Satin chrome
-  **Light black**
Light black
-  **Neropaco**
Matt black

K 3020 RT · Fusital

Ottone / Brass

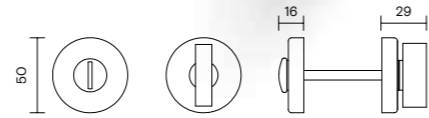







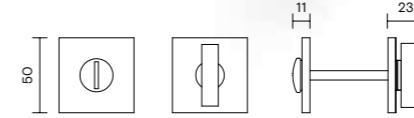

-  **Cromo**
Polished chrome
-  **Cromosat**
Satin chrome
-  **Bronzo scuro**
Dark bronze

K 3020 RB · Lab

Ottone / Brass



-  **Cromo**
Polished chrome
-  **Cromosat**
Satin chrome
-  **Bronzsat**
Bronzsat
-  **Bronzo scuro**
Dark bronze
-  **Brunito**
Burnished
-  **Light black**
Light black
-  **Neropaco**
Matt black
-  **Nikelnero**
Black nickel
-  **Orolucido**
Polished brass
-  **Titanium PVD**
Titanium PVD

K 3020 RG · Lab

Ottone / Brass

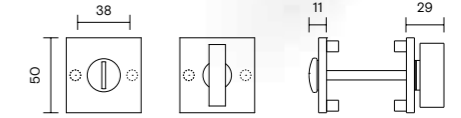
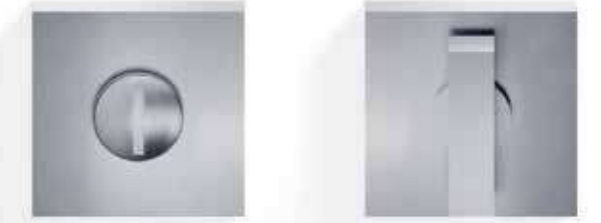

-  **Cromo**
Polished chrome
-  **Cromosat**
Satin chrome
-  **Bronzsat**
Bronzsat
-  **Brunito**
Burnished
-  **Light black**
Light black
-  **Nikelnero**
Black nickel
-  **Orolucido**
Polished brass
-  **Titanium PVD**
Titanium PVD

K 3020 RB T · Lab

Ottone / Brass

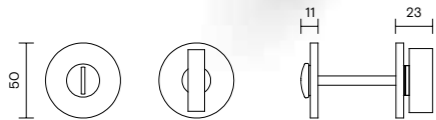







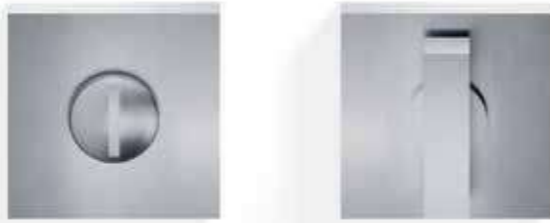



-  **Cromo**
Polished chrome
-  **Cromosat**
Satin chrome
-  **Bronzo scuro**
Dark bronze

K 3020 · Lab

Ottone / Brass



-  **Cromo**
Polished chrome
-  **Cromosat**
Satin chrome
-  **Bronzsat**
Bronzsat
-  **Bronzo scuro**
Dark bronze
-  **Brunito**
Burnished
-  **Light black**
Light black
-  **Neropaco**
Matt black
-  **Nikelnero**
Black nickel
-  **Orolucido**
Polished brass
-  **Titanium PVD**
Titanium PVD

K 3020 RG B · Lab

Ottone / Brass

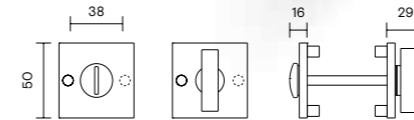



-  **Cromo**
Polished chrome
-  **Cromosat**
Satin chrome
-  **Bronzsat**
Bronzsat
-  **Bronzo scuro**
Dark bronze
-  **Brunito**
Burnished
-  **Light black**
Light black
-  **Nikelnero**
Black nickel
-  **Orolucido**
Polished brass
-  **Titanium PVD**
Titanium PVD

K 1867 · Lab

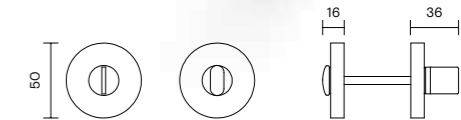
Rame / Copper



-  **Metallo rame lucido**
Polished pure copper
-  **Metallo rame satinato**
Satin pure copper

Chiusure privacy BZG / Bathroom privacy sets

K 1867 RS · Lab

Rame / Copper

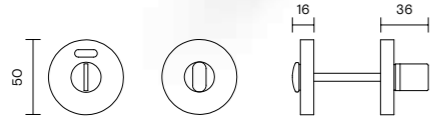



 **Metallo rame lucido**
Polished pure copper

 **Metallo rame satinato**
Satin pure copper

K 1865 RB · Lab

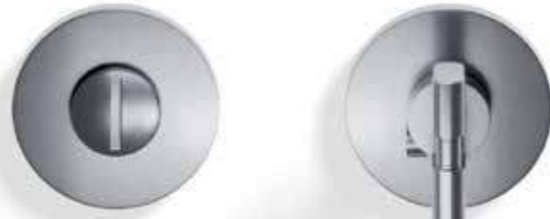
Acciaio + Ottone / Steel + Brass



 **Cromo**
Polished chrome

 **Cromosat**
Satin chrome

 **Nikelnero**
Black nickel

K 1864 RG B · Lab

Acciaio + Ottone / Steel + Brass

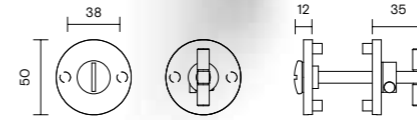

 **Cromosat**
Satin chrome

 **Neropaco**
Matt black

 **Biancopaco**
Matt white

K 1740 R · Lab

Ottone / Brass

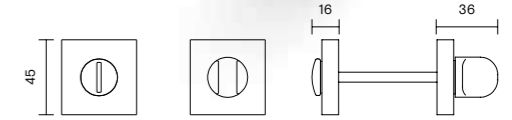
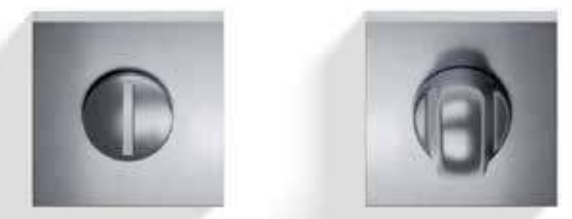

 **Cromo**
Polished chrome

 **Cromosat**
Satin chrome

 **Neropaco**
Matt black

K 1865 RG B · Lab

Acciaio + Ottone / Steel + Brass

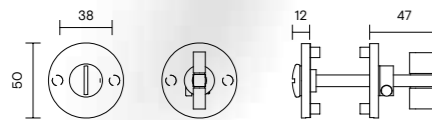

 **Cromo**
Polished chrome

 **Cromosat**
Satin chrome

 **Nikelnero**
Black nickel

K 1864 RB · Lab

Acciaio + Ottone / Steel + Brass



 **Cromosat**
Satin chrome

 **Neropaco**
Matt black

 **Biancopaco**
Matt white

K 1740 RB · Lab

Ottone / Brass

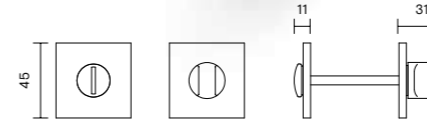
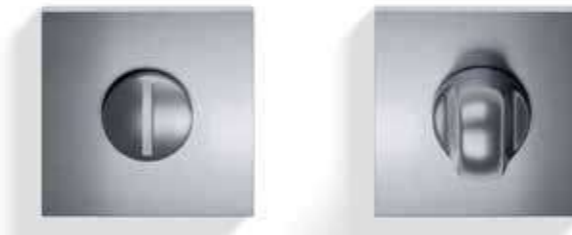

 **Cromo**
Polished chrome

 **Cromosat**
Satin chrome

 **Neropaco**
Matt black

K 1704 R · Lab

Ottone / Brass

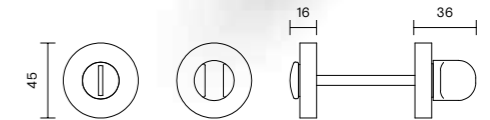

 **Cromo**
Polished chrome

 **Cromosat**
Satin chrome

 **Anticato**
Antique

 **Bronzop**
Matt bronze

 **Bronzsat**
Bronzsat

 **Brunito**
Burnished

 **Neropaco**
Matt black

 **Nikmatt**
Nikmatt

 **Orolucido**
Polished brass

 **Orsatin**
Satin brass

 **Orsatop**
Matt brass

 **Ottone antico**
Antique brass

 **Ottone naturale**
Natural brass

Chiusure privacy BZG / Bathroom privacy sets

K 1704 RS · Lab

Ottone / Brass



- | | | |
|--------------------------|-----------------------------|----------------------------------|
| Cromo
Polished chrome | Brunito
Burnished | Orsatop
Matt brass |
| Cromosat
Satin chrome | Neropaco
Matt black | Ottone antico
Antique brass |
| Anticato
Antique | Nikmatt
Nikmatt | Ottone naturale
Natural brass |
| Bronzop
Matt bronze | Orolucido
Polished brass | |
| Bronzsat
Bronzsat | Orsatin
Satin brass | |

K 1704 R 50 · Lab

Ottone / Brass



- | | | |
|--------------------------|-----------------------------|-----------------------------|
| Cromo
Polished chrome | Bronzsat
Bronzsat | Nikmatt
Nikmatt |
| Cromosat
Satin chrome | Bronzo scuro
Dark bronze | Orolucido
Polished brass |
| Anticato
Antique | Light black
Light black | Orsatin
Satin brass |
| Biancopaco
Matt white | Neropaco
Matt black | Orsatop
Matt brass |
| Bronzop
Matt bronze | Nikelnero
Black nickel | |

K 1233 · Lab

Ottone / Brass



- | | |
|----------------------------|--------------------------|
| Cromo
Polished chrome | Cromosat
Satin chrome |
| Light black
Light black | Neropaco
Matt black |

K 1233 RS · Lab

Ottone / Brass

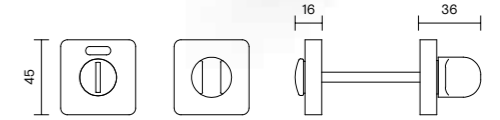

- | | |
|----------------------------|--------------------------|
| Cromo
Polished chrome | Cromosat
Satin chrome |
| Light black
Light black | Neropaco
Matt black |

K 1704 RB 50 · Lab

Ottone / Brass

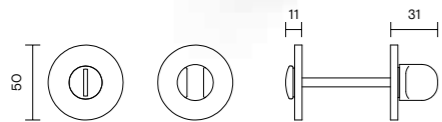

- | | | |
|--------------------------|-----------------------------|-----------------------------|
| Cromo
Polished chrome | Bronzsat
Bronzsat | Nikmatt
Nikmatt |
| Cromosat
Satin chrome | Bronzo scuro
Dark bronze | Orolucido
Polished brass |
| Anticato
Antique | Light black
Light black | Orsatin
Satin brass |
| Biancopaco
Matt white | Neropaco
Matt black | Orsatop
Matt brass |
| Bronzop
Matt bronze | Nikelnero
Black nickel | |

K 1704 RS 50 · Lab

Ottone / Brass



- | | | |
|--------------------------|-----------------------------|-----------------------|
| Cromo
Polished chrome | Bronzo scuro
Dark bronze | Orsatop
Matt brass |
| Cromosat
Satin chrome | Light black
Light black | |
| Anticato
Antique | Neropaco
Matt black | |
| Biancopaco
Matt white | Nikmatt
Nikmatt | |
| Bronzop
Matt bronze | Orolucido
Polished brass | |

K 1123 RG · Lab

Ottone / Brass



- | | | |
|--------------------------|-----------------------------|----------------------------------|
| Cromo
Polished chrome | Brunito
Burnished | Orsatop
Matt brass |
| Cromosat
Satin chrome | Neropaco
Matt black | Ottone antico
Antique brass |
| Anticato
Antique | Nikmatt
Nikmatt | Ottone naturale
Natural brass |
| Biancopaco
Matt white | Orolucido
Polished brass | |
| Bronzop
Matt bronze | Orsatin
Satin brass | |

K 1123 RG B · Lab

Ottone / Brass

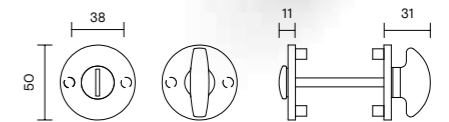
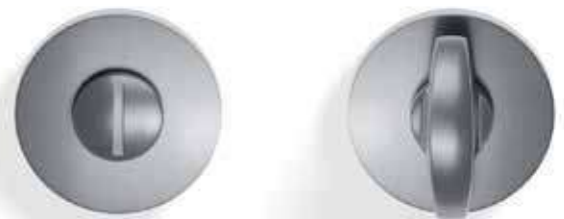

- | | | |
|--------------------------|-----------------------------|----------------------------------|
| Cromo
Polished chrome | Brunito
Burnished | Orsatop
Matt brass |
| Cromosat
Satin chrome | Neropaco
Matt black | Ottone antico
Antique brass |
| Anticato
Antique | Nikmatt
Nikmatt | Ottone naturale
Natural brass |
| Biancopaco
Matt white | Orolucido
Polished brass | |
| Bronzop
Matt bronze | Orsatin
Satin brass | |

Chiusure privacy BZG / Bathroom privacy sets

K 412 · Lab

Acciaio inox AISI 304 / Stainless steel AISI 304

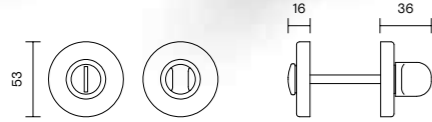

● Acciaio inox satinato
Satin stainless steel

K 411 · Lab

Acciaio inox AISI 304 / Stainless steel AISI 304

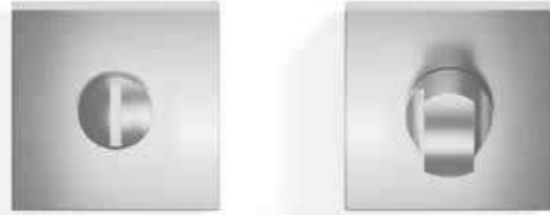

● Acciaio inox satinato
Satin stainless steel

S 5505 RS Foster + Partners · Fusital

Acciaio inox AISI 316 L / Stainless steel AISI 316 L

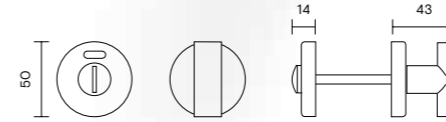

● Acciaio inox satinato
Satin stainless steel

● Acciaio inox lucido
Polished stainless steel

S 5501 · Lab

Acciaio inox AISI 316 L / Stainless steel AISI 316 L

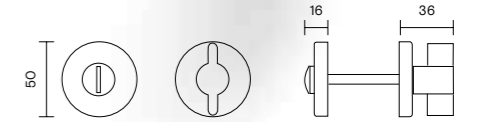

● Acciaio inox satinato
Satin stainless steel

● Acciaio inox lucido
Polished stainless steel

K 43 · Lab

Ottone / Brass



● Cromo
Polished chrome

● Cromosat
Satin chrome

● Orolucido
Polished brass

● Orsatin
Satin brass

S 5505 Foster + Partners · Fusital

Acciaio inox AISI 316 L / Stainless steel AISI 316 L

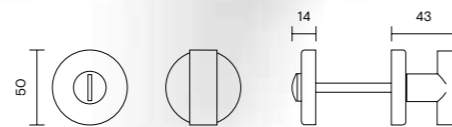
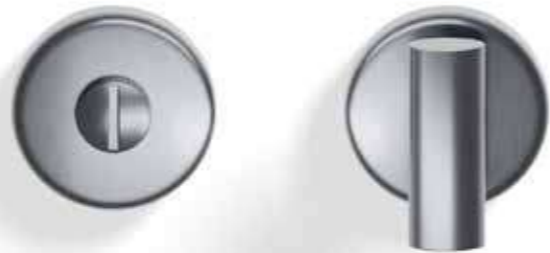

● Acciaio inox satinato
Satin stainless steel

● Acciaio inox lucido
Polished stainless steel

S 5501 RS · Lab

Acciaio inox AISI 316 L / Stainless steel AISI 316 L

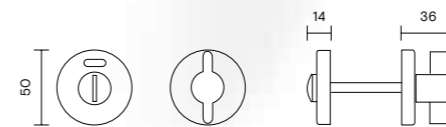

● Acciaio inox satinato
Satin stainless steel

● Acciaio inox lucido
Polished stainless steel

S 5501 RG · Lab

Acciaio inox AISI 316 L / Stainless steel AISI 316 L



● Acciaio inox satinato
Satin stainless steel

● Acciaio inox lucido
Polished stainless steel

Fermaporta a pavimento / Door stops

L 193 · Lab

Ottone / Brass

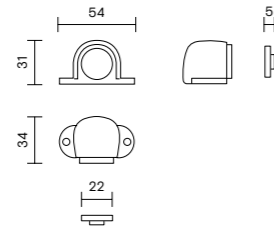

Con calamita.
With magnet.

- Cromo
Polished chrome
- Cromosat
Satin chrome
- Anticato
Antique
- Orolucido
Polished brass

L 190 · Lab

Ottone / Brass

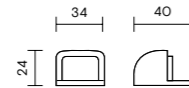

- Cromo
Polished chrome
- Cromosat
Satin chrome
- Brunito
Burnished
- Orolucido
Polished brass

L 490 · Lab

Acciaio inox AISI 304 / Stainless steel AISI 304

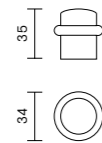

- Acciaio inox satinato
Satin stainless steel
- Acciaio inox lucido
Polished stainless steel

Porta abiti - Ganci / Coat hooks - Hooks

E 183 · Lab

Ottone / Brass

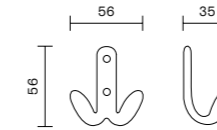

- Cromo
Polished chrome
- Cromosat
Satin chrome
- Brunito
Burnished
- Orolucido
Polished brass

E 182 · Lab

Ottone / Brass

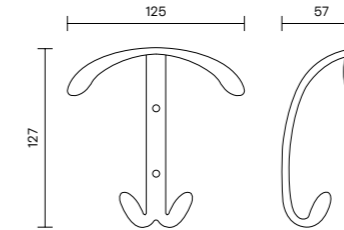

- Cromo
Polished chrome
- Cromosat
Satin chrome
- Brunito
Burnished
- Orolucido
Polished brass

E 180 · Lab

Ottone / Brass

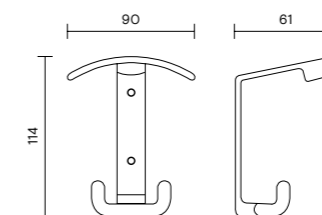

- Cromosat
Satin chrome
- Orolucido
Polished brass

Informazioni tecniche
Technical informations



Fusital

H 1026
Antonio Bullo

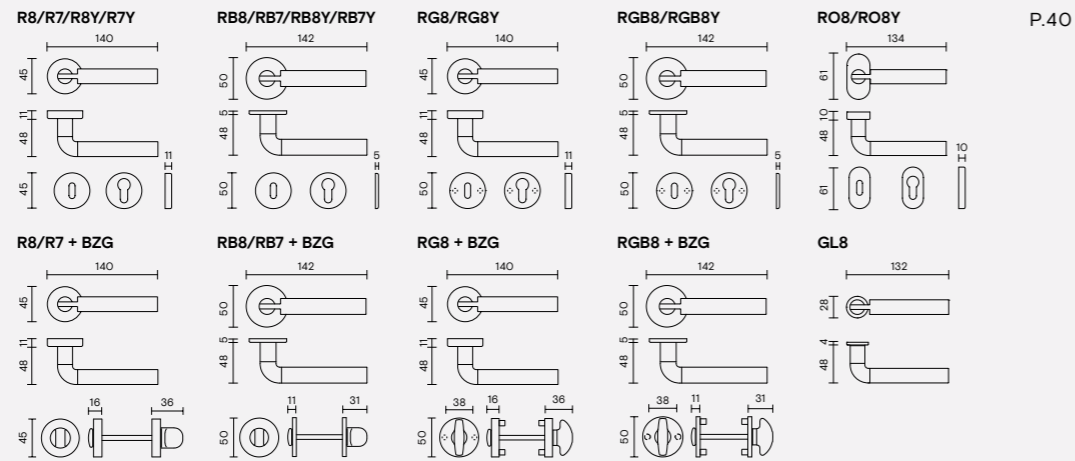

H 380
Antonio Citterio

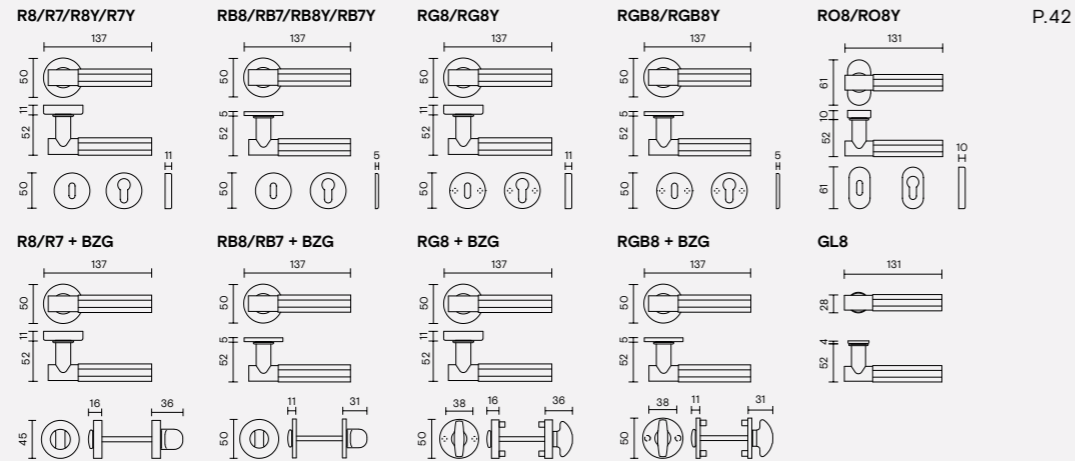

H 379
Antonio Citterio

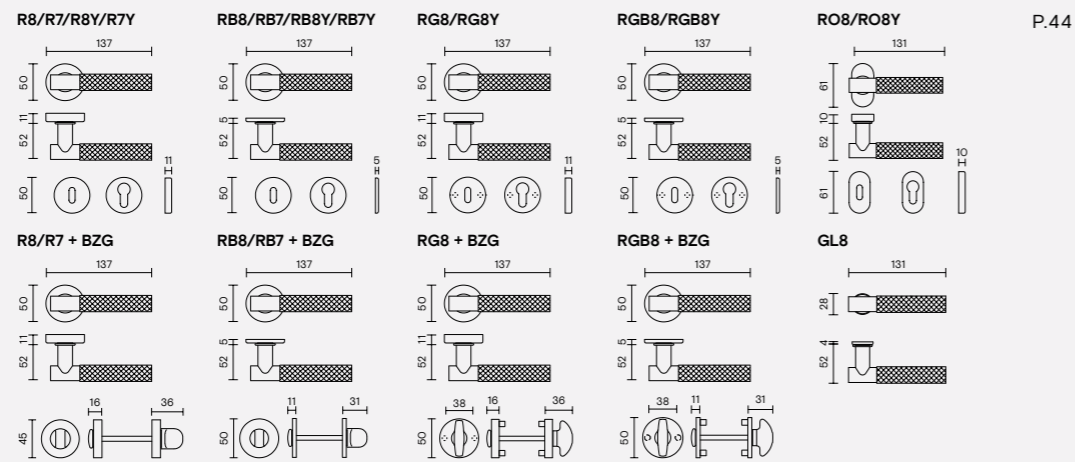

H 327
Antonio Citterio

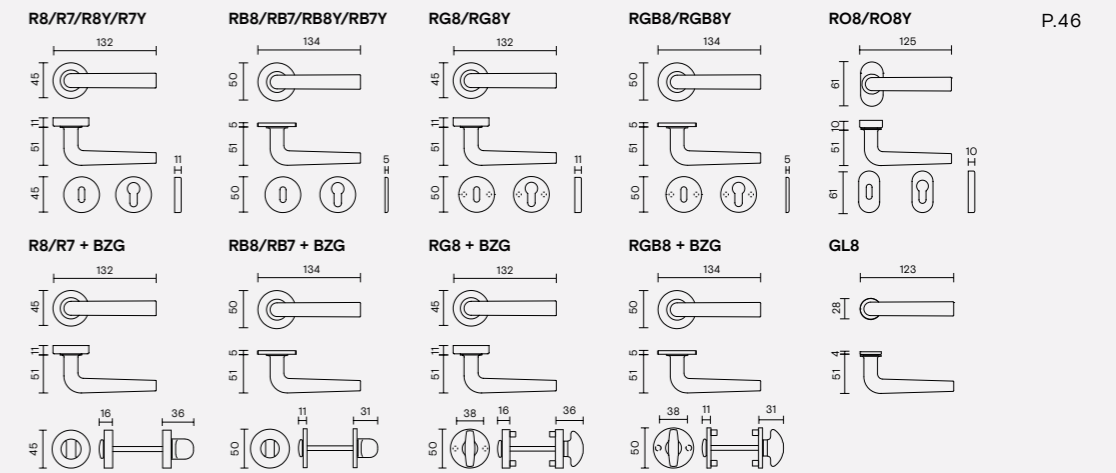

H 317
Antonio Citterio

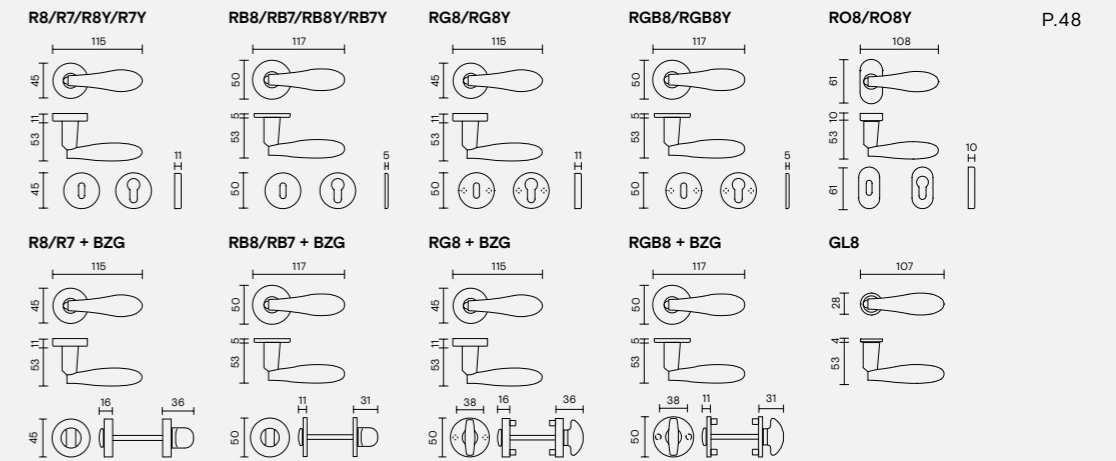

H 5015
Antonio Citterio

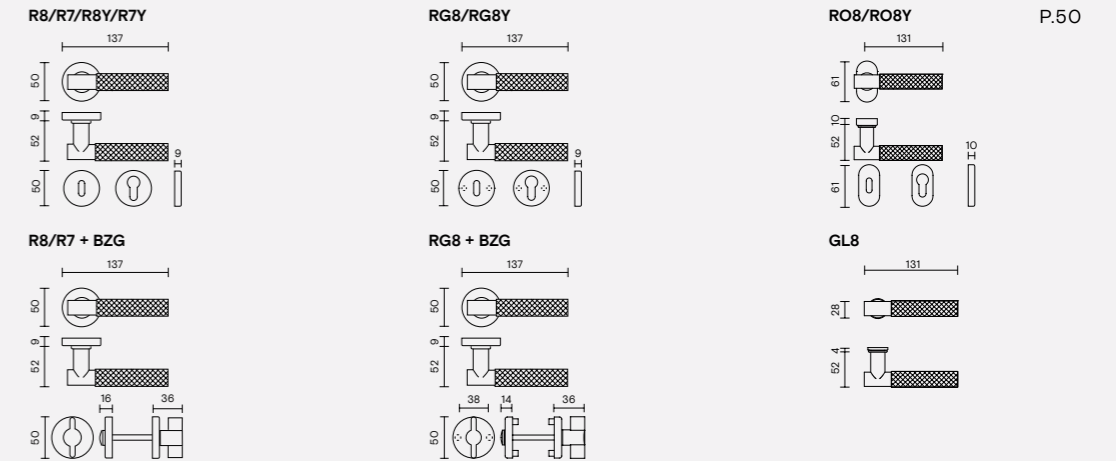

H 361
Antonio Citterio -
Toan Nguyen

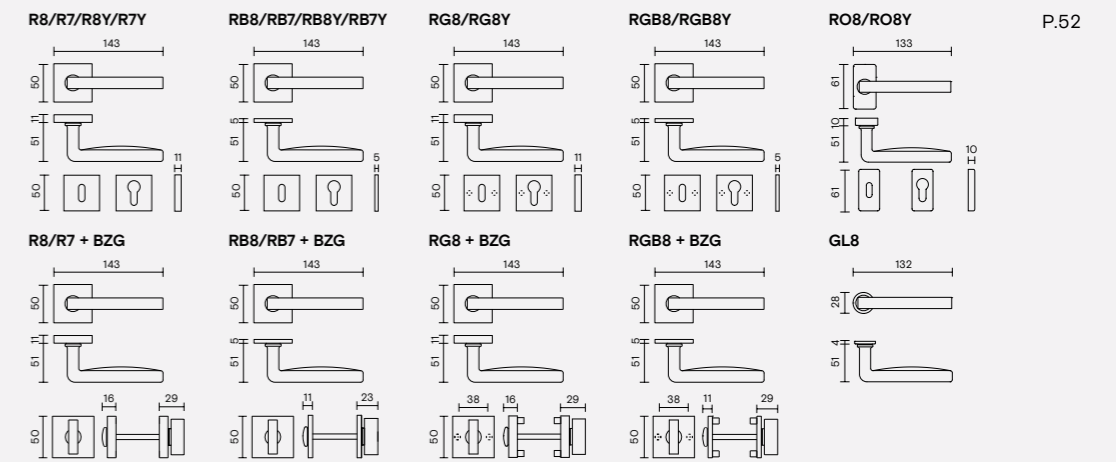

H 1066
Bertone Design

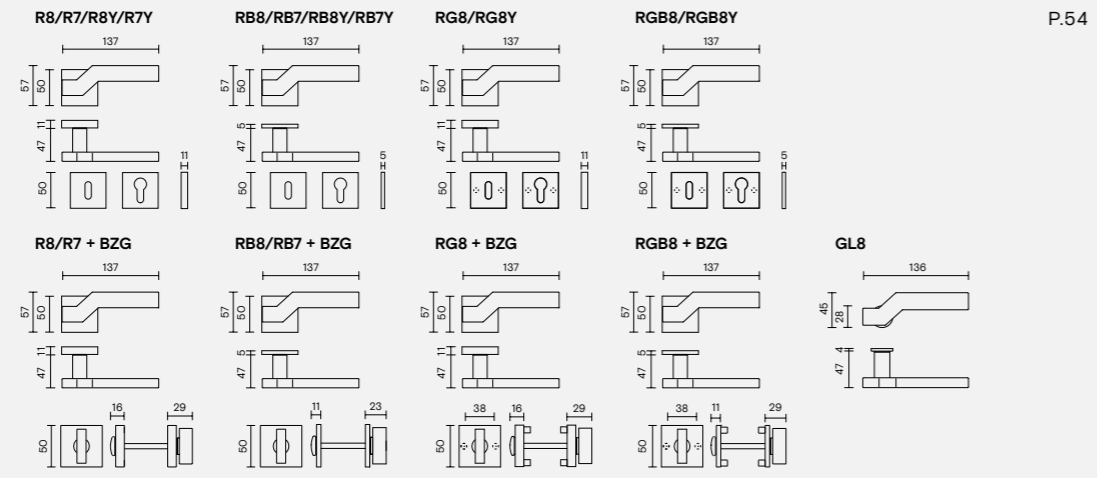

P.54

H 1061
Di Virgilio Veneziano

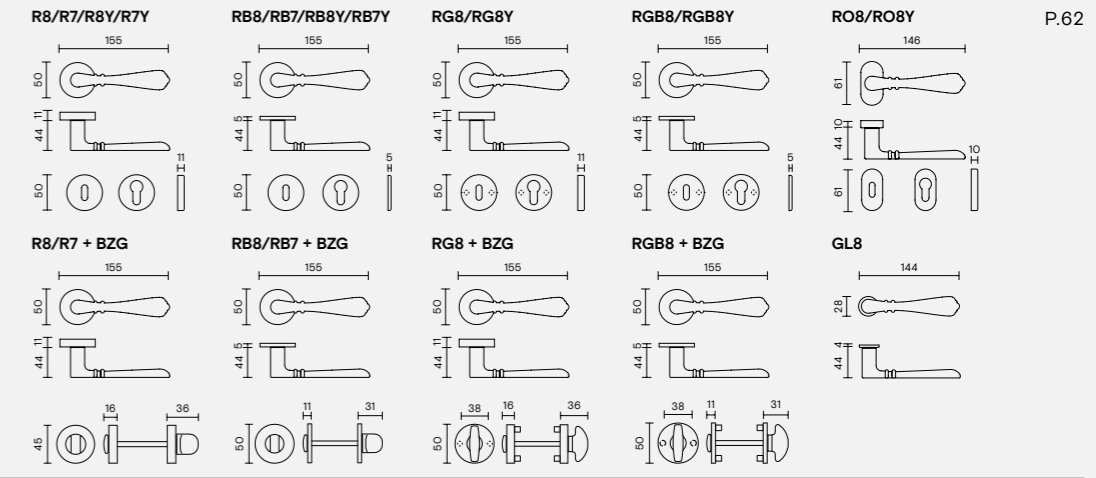

P.62

H 368
Ceri & Associati

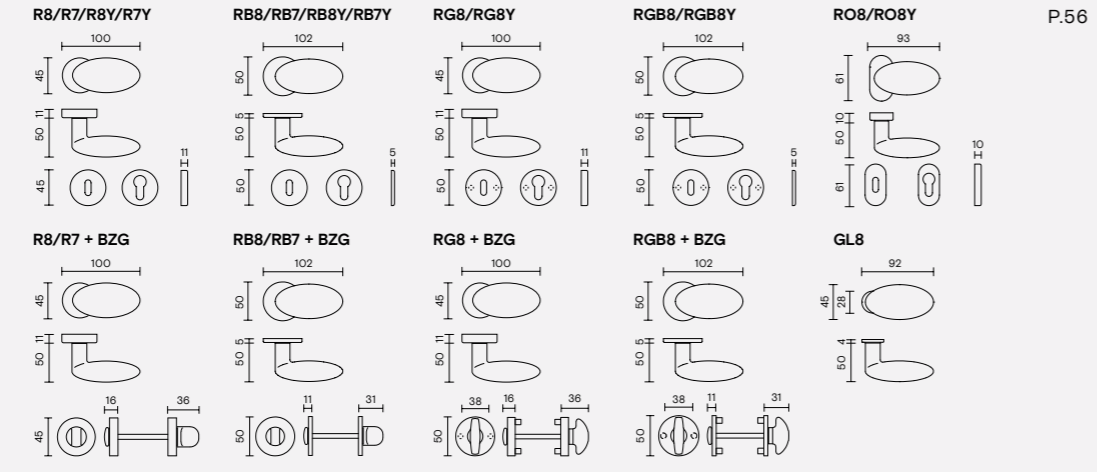

P.56

H 370
Doriana e Massimiliano Fuksas

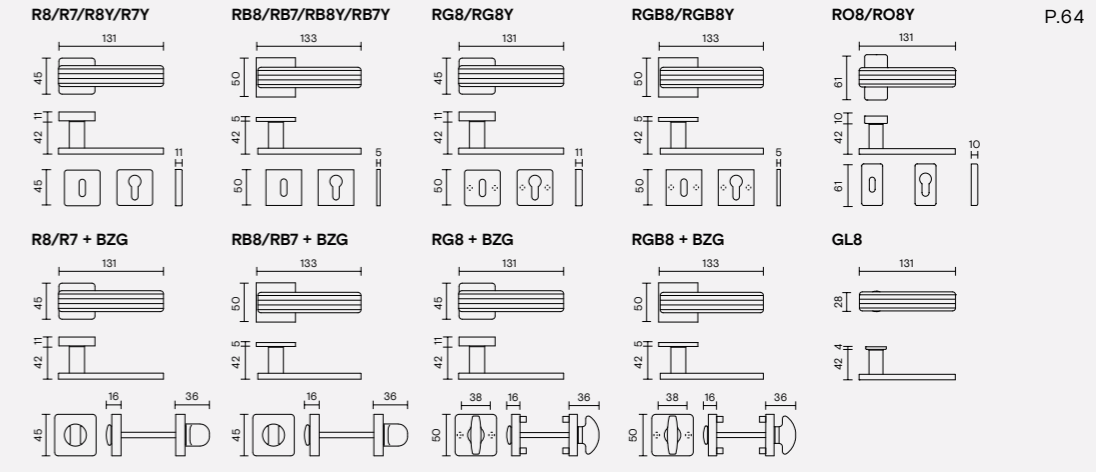

P.64

H 384
CetraRuddy
Architecture D.P.C.

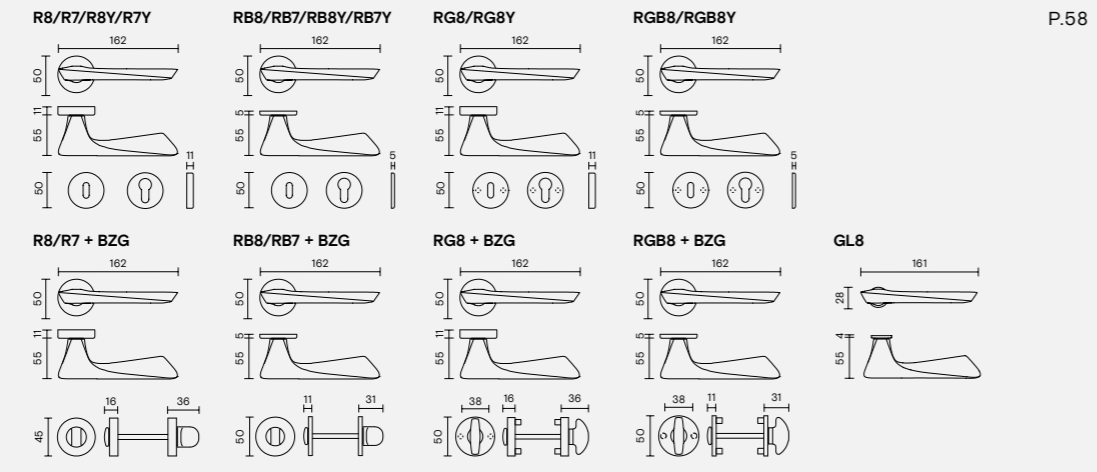

P.58

H 198
Eero Aarnio

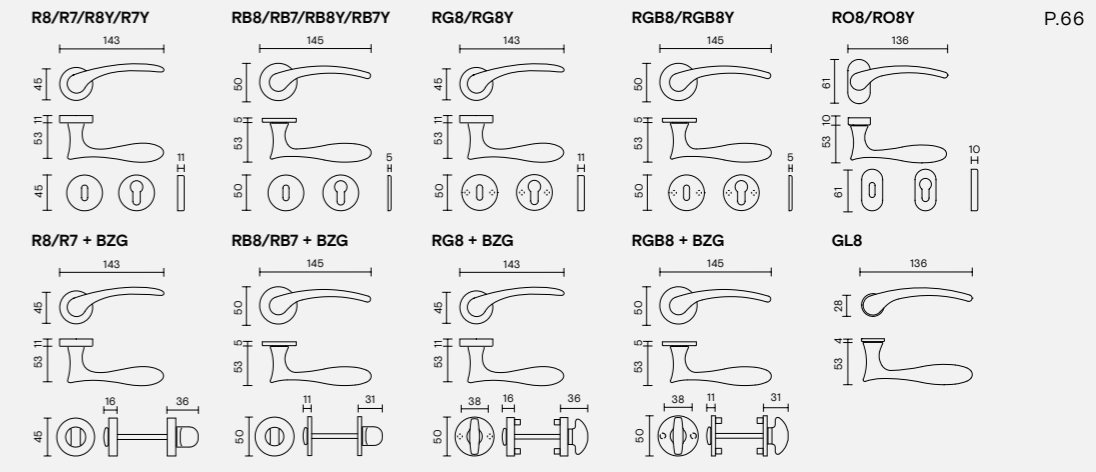

P.66

H 348
David Chipperfield

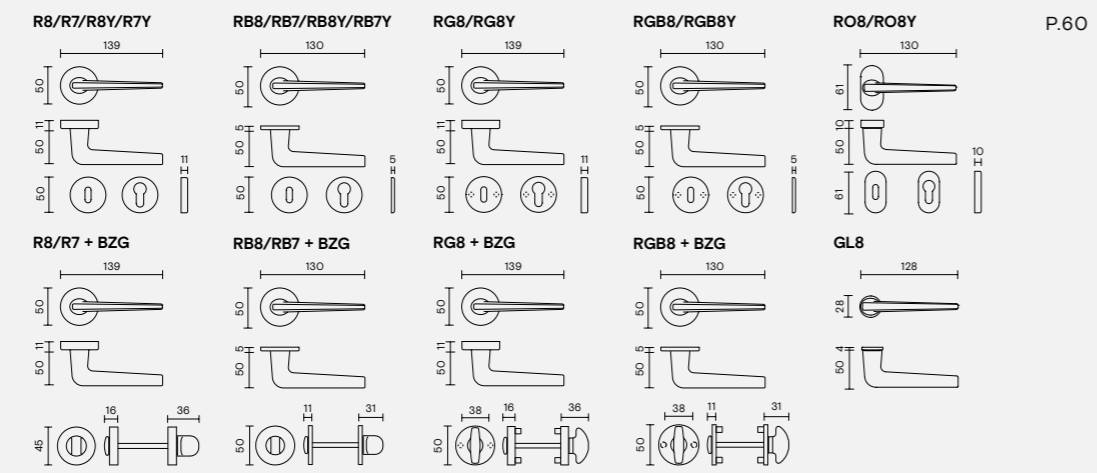

P.60

H 372
Eri Goshen

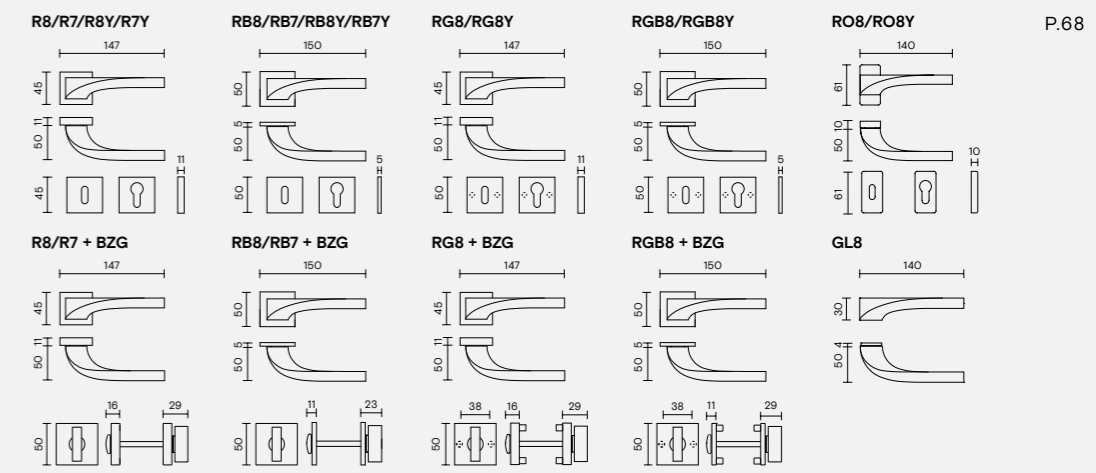

P.68

H 385
Federica Biasi

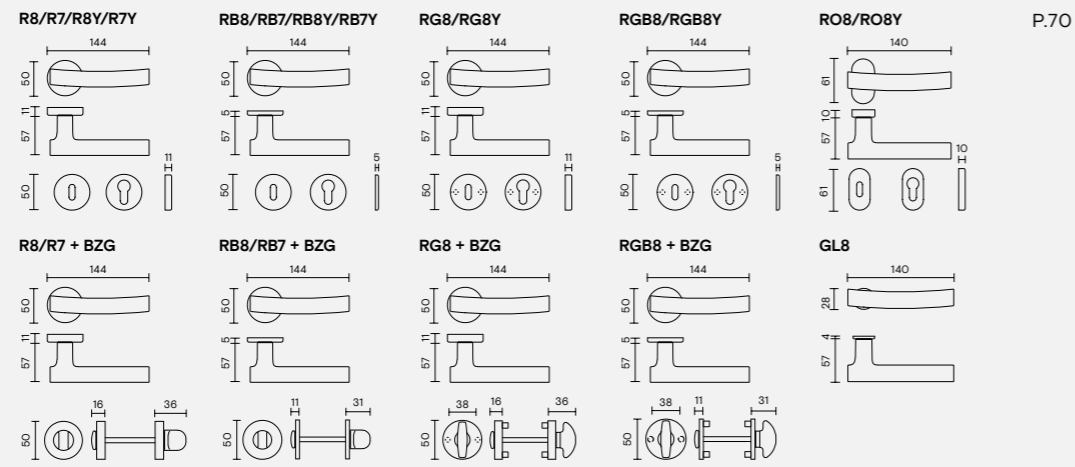

H 334
Foster + Partners

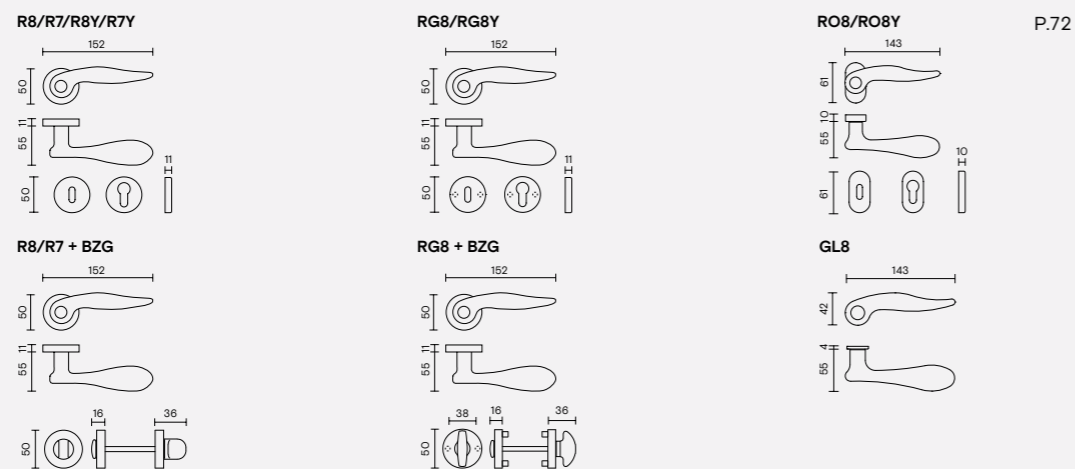

H 374
Franco Poli

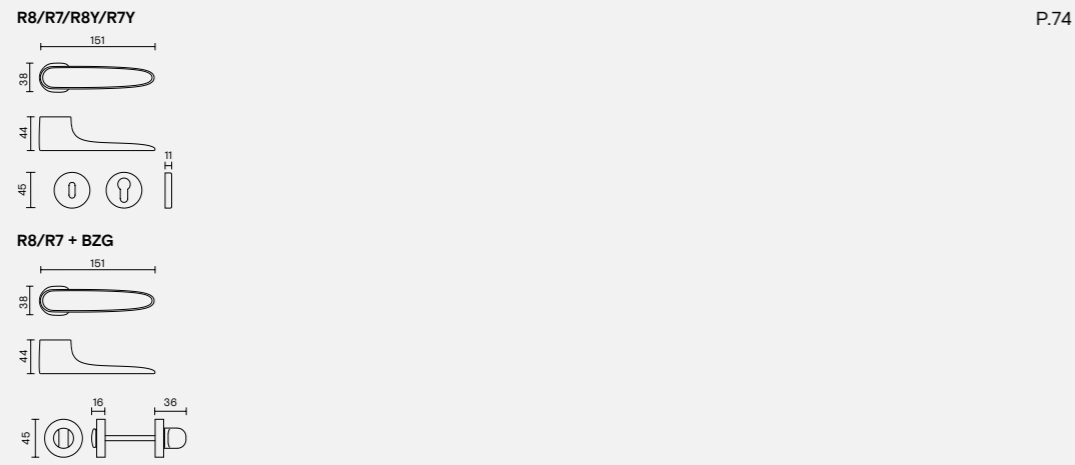

H 1040
Gabriele e Oscar Buratti

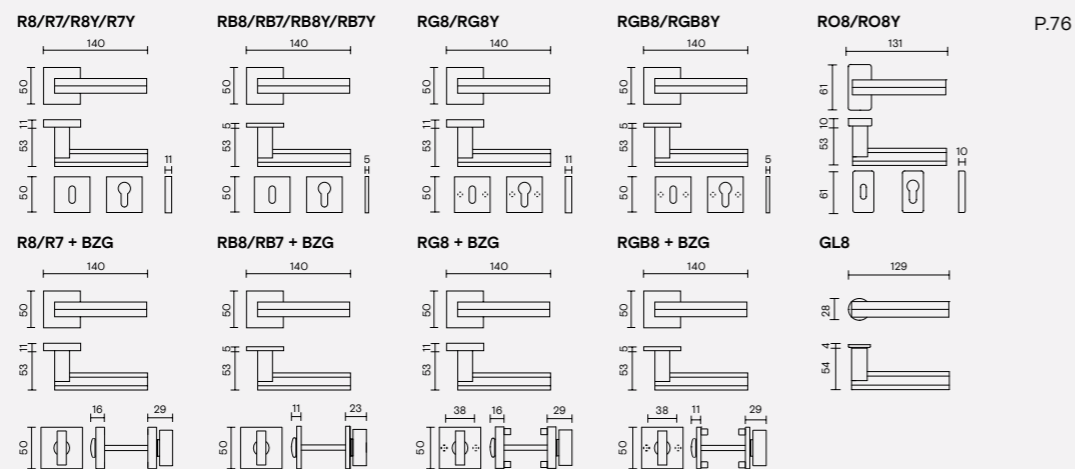

H 376
Giancarlo Vegni

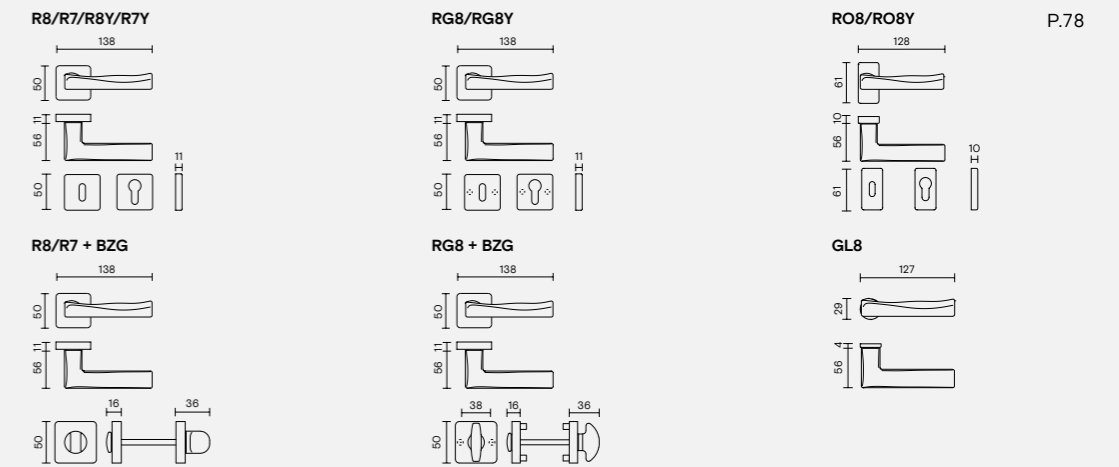

H 367
Giancarlo Vegni

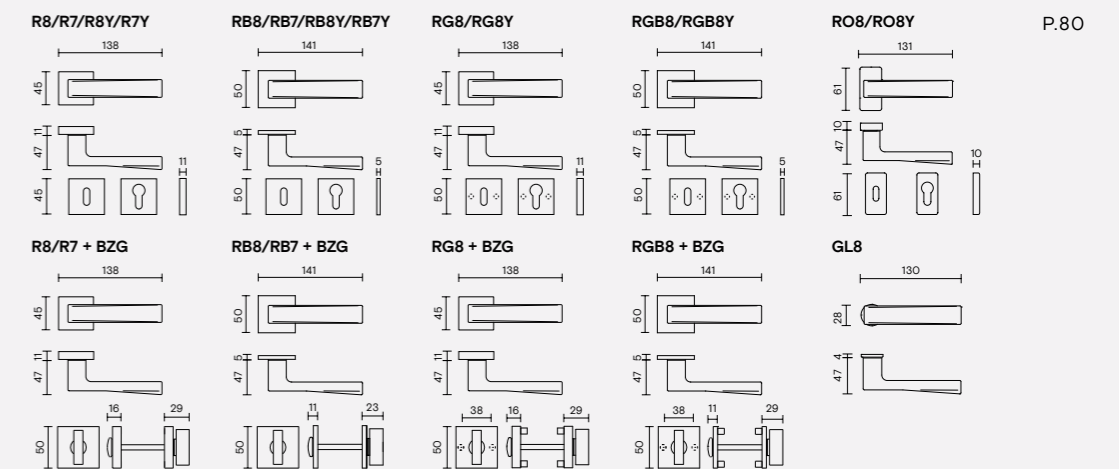

H 5017
Hans Kollhoff

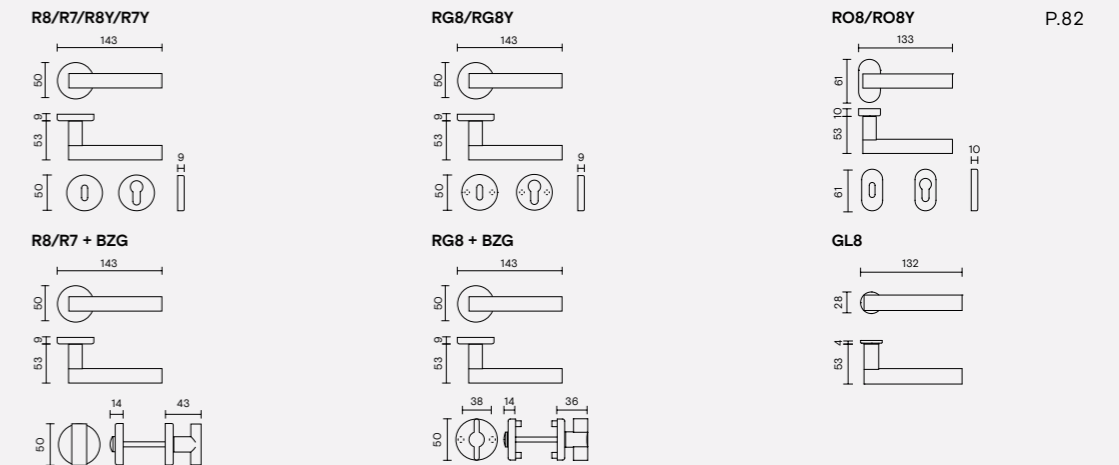
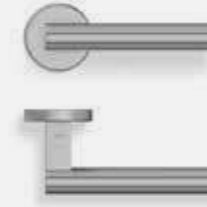

H 1039
Jean-Baptiste Sibertin Blanc

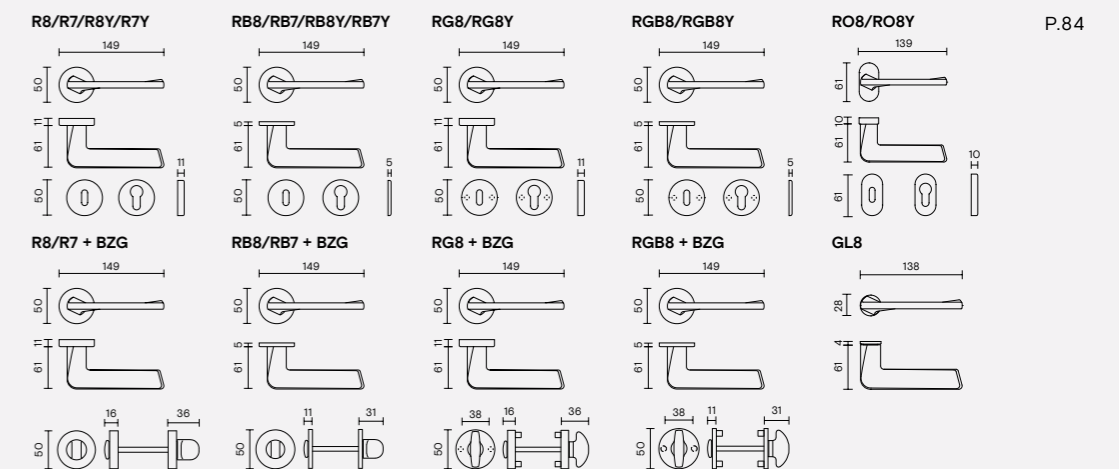

H 382
Joe Cheng

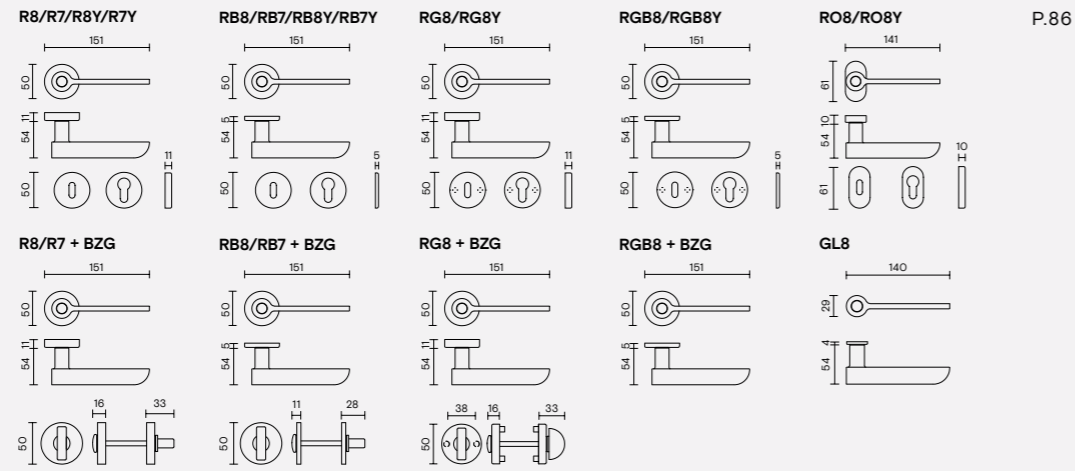

H 311
Mario Bellini

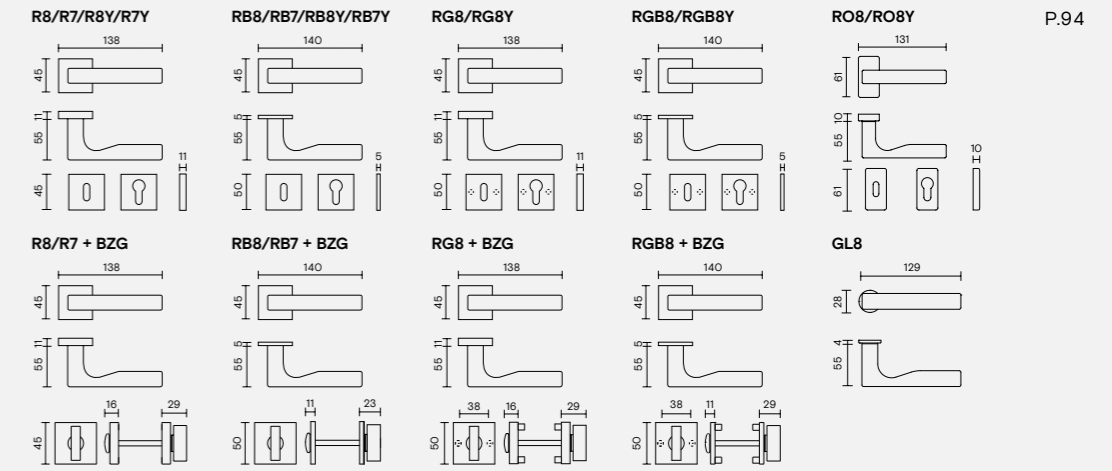

H 343
John Pawson

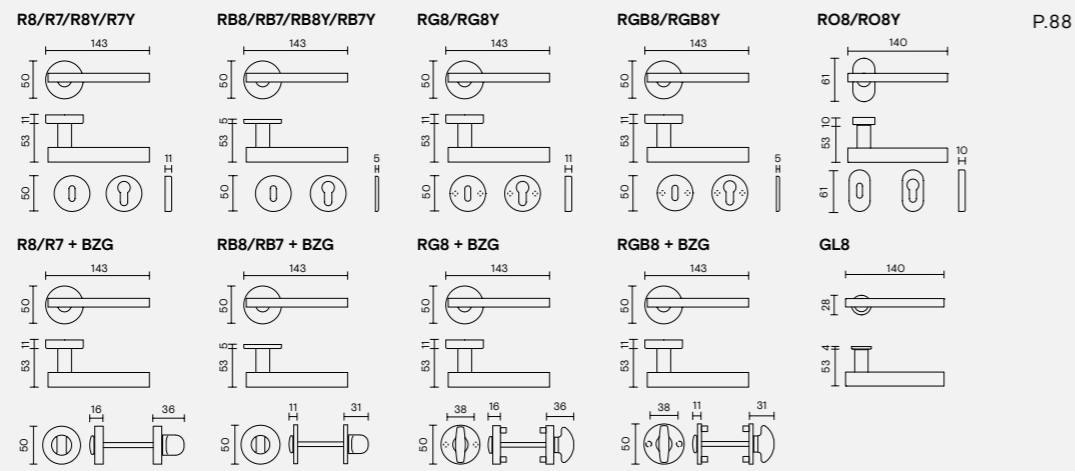

H 1043
Matteo Thun

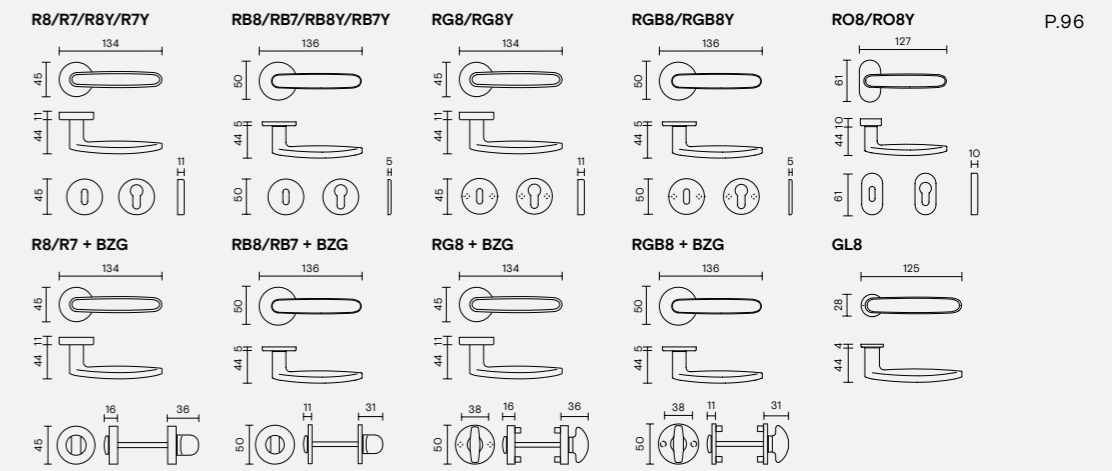

H 381
Khalid Al Najjar

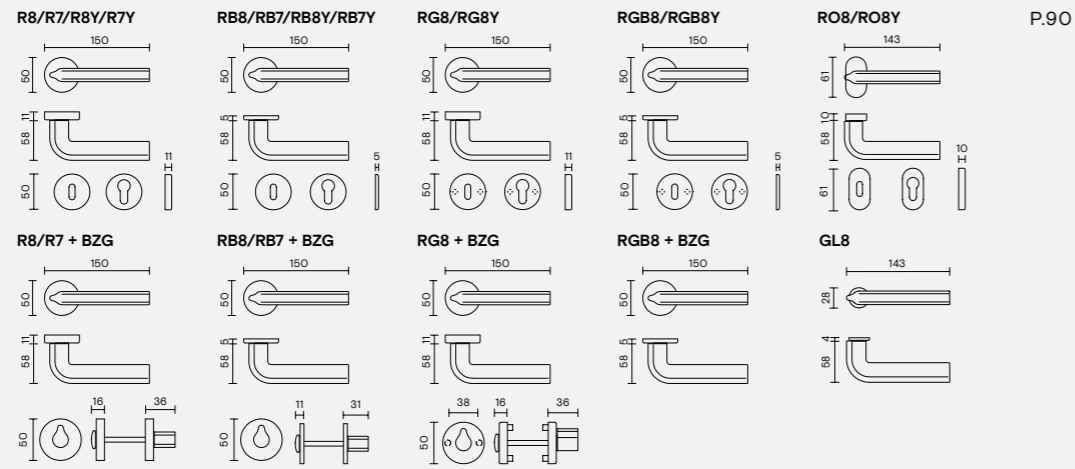

H 1003
Matteo Thun

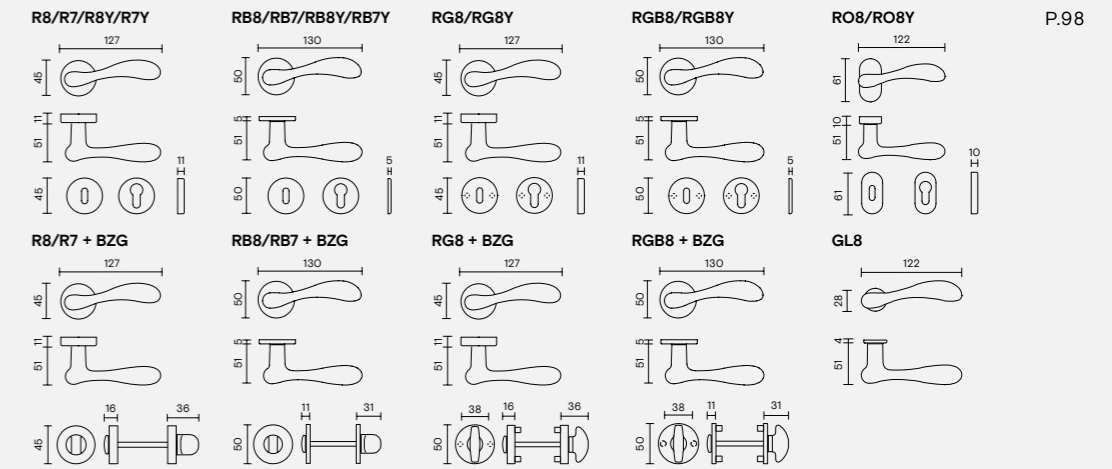

H 364
Mario Bellini

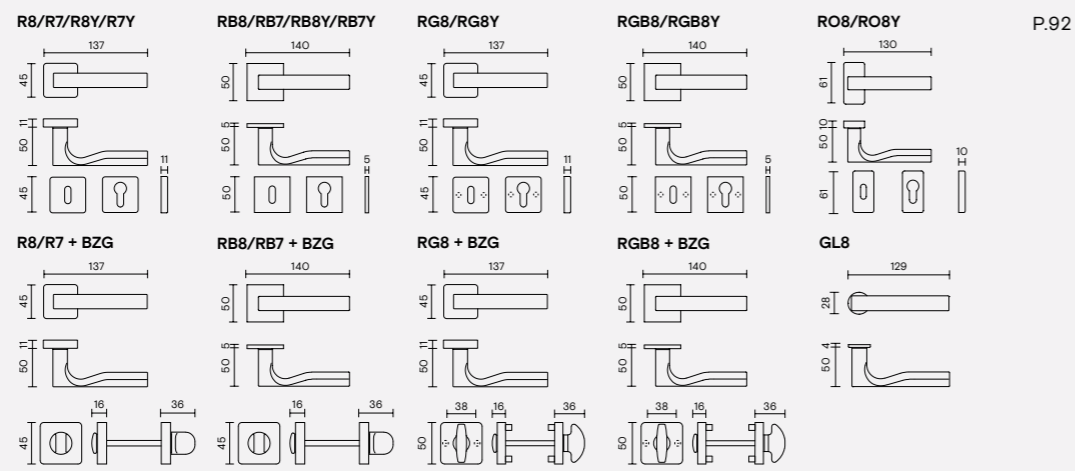

H 330
Matteo Thun

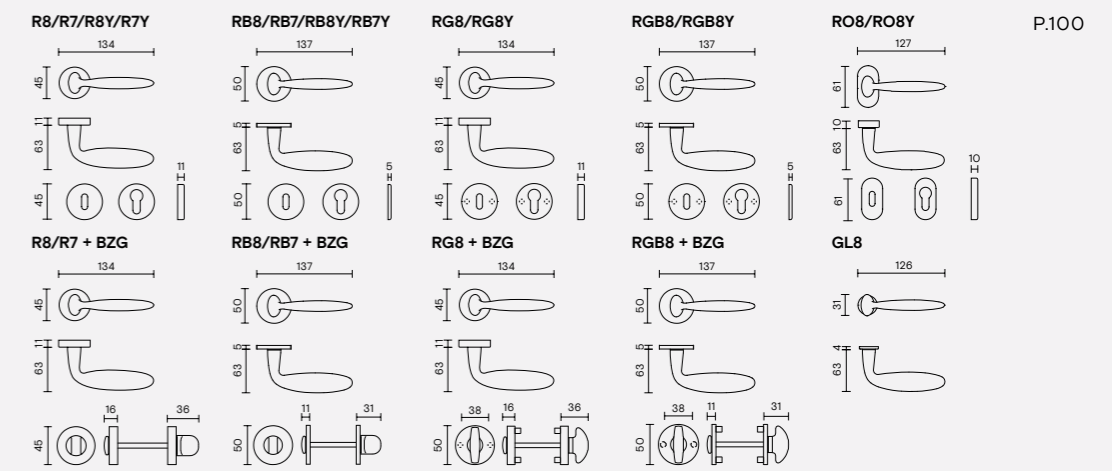

H 386
Meneghello Paoletti

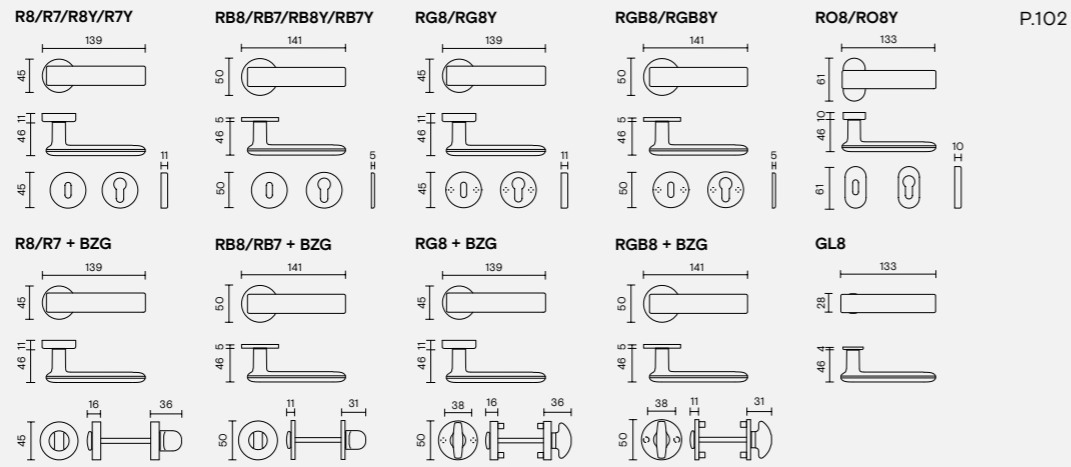

H 1052
Mikhail Leykin

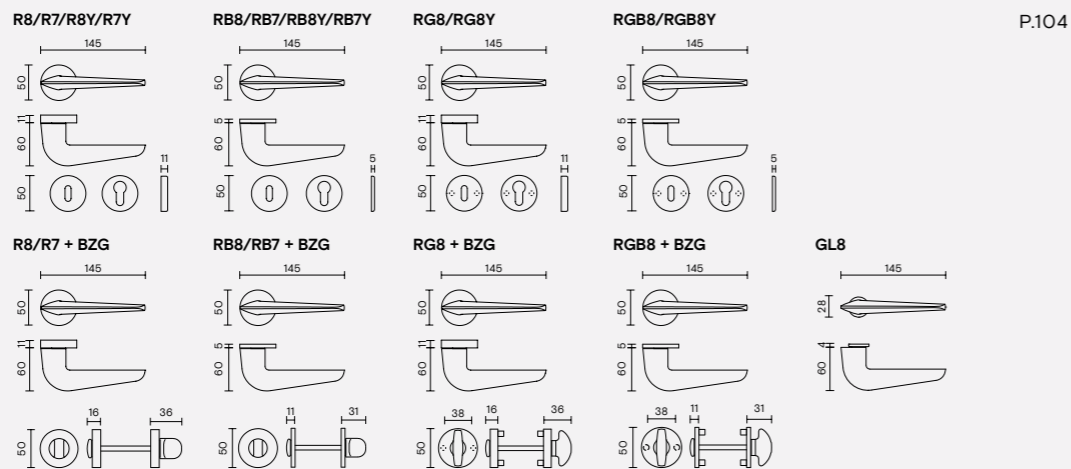

H 1068
Pembroke & Ives

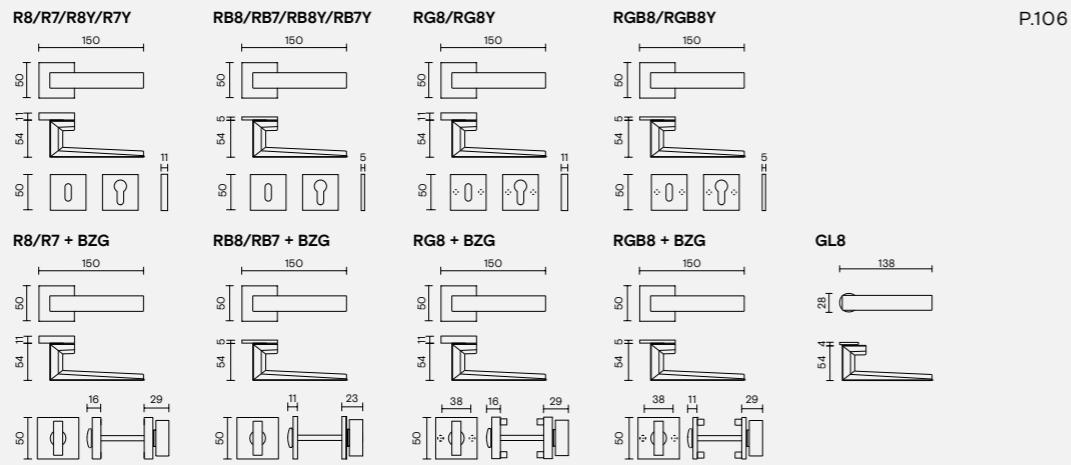

H 383
Perkins&Will

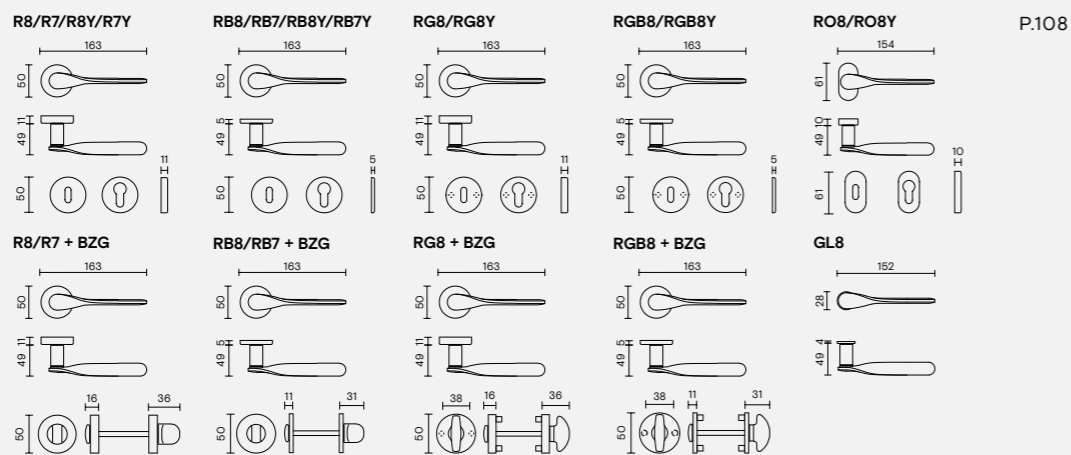

H 315
Pierluigi Cerri

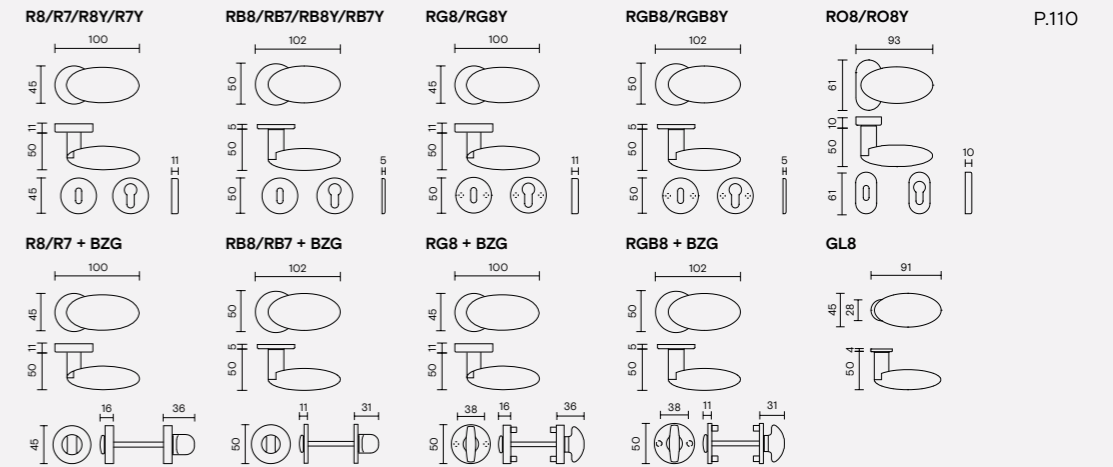

H 335
Richard Meier

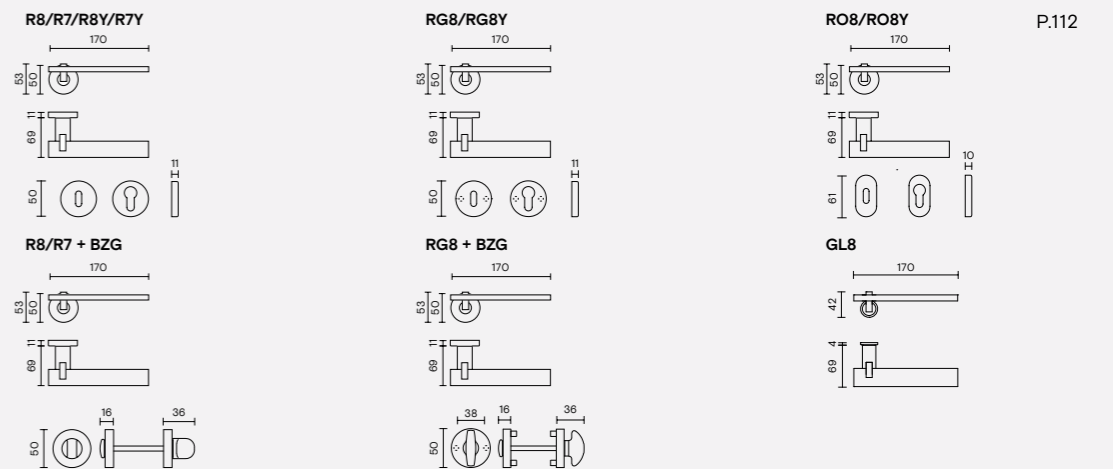

H 359
Skidmore, Owings & Merrill

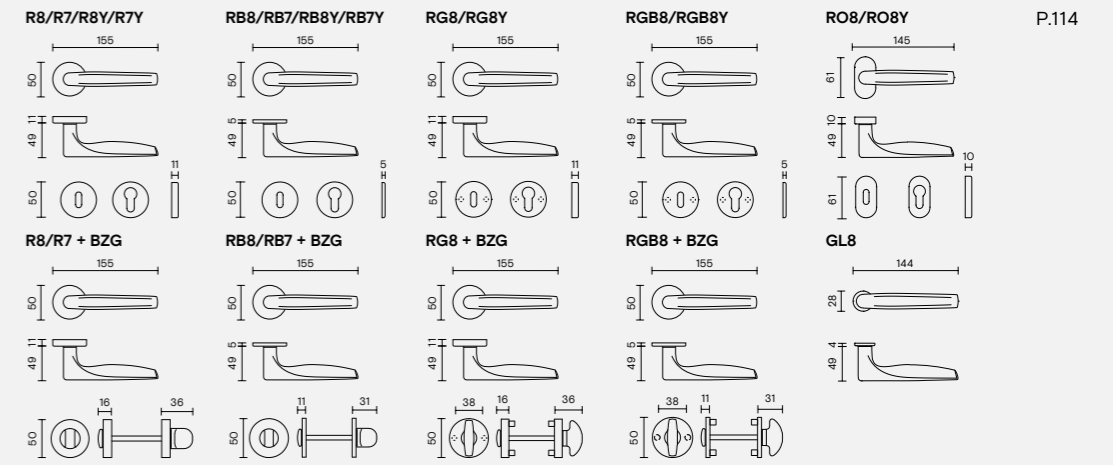

H 377
Steve Leung

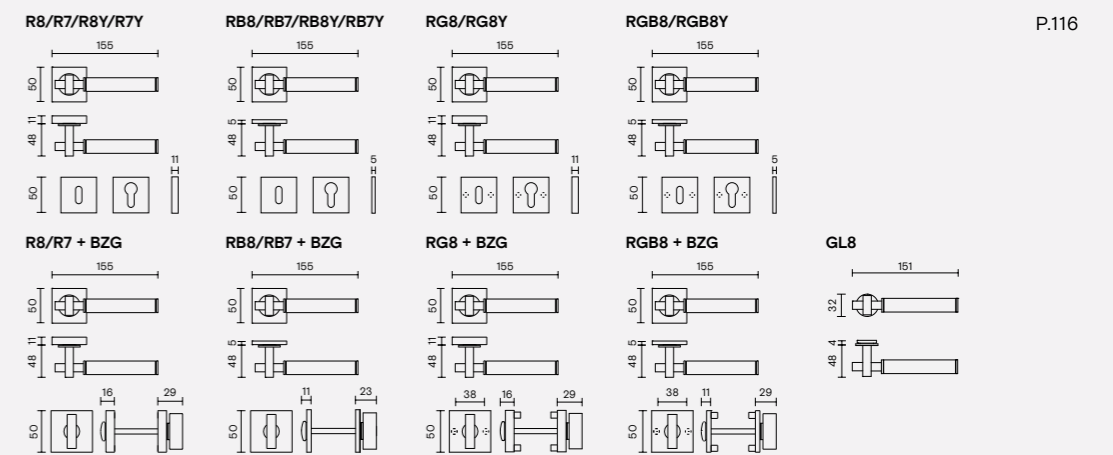

H 377 P
Steve Leung

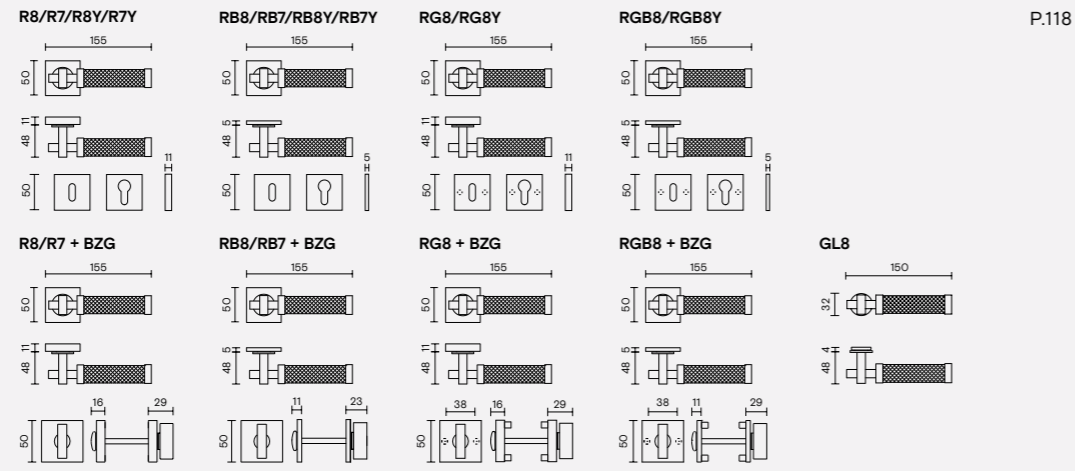

H 329
Taller Design
Ricardo Bofill

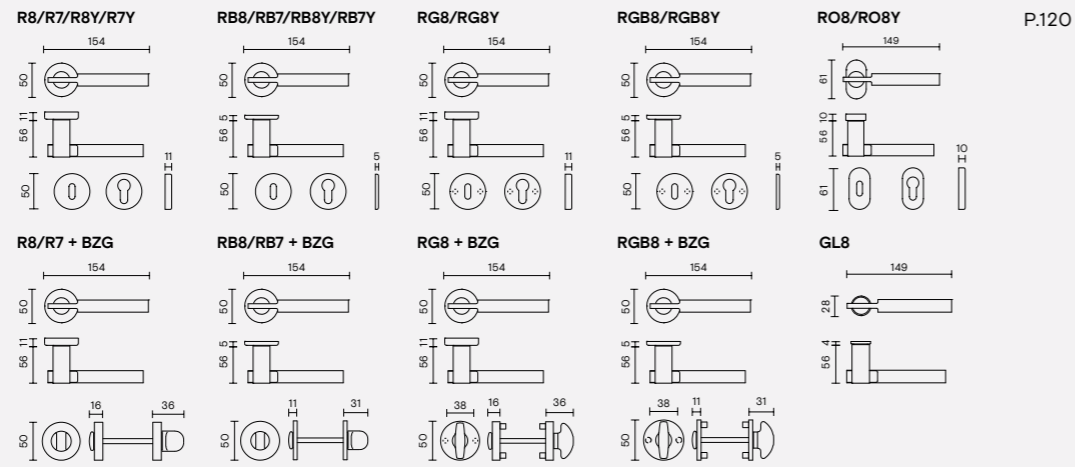

H 5008
Taller Design
Ricardo Bofill

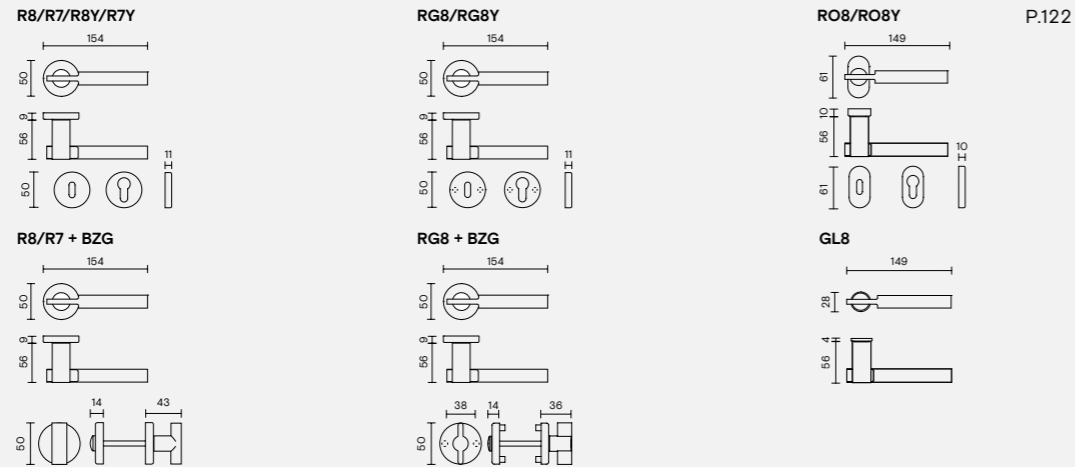

H 1044
Vincent Van Duysen

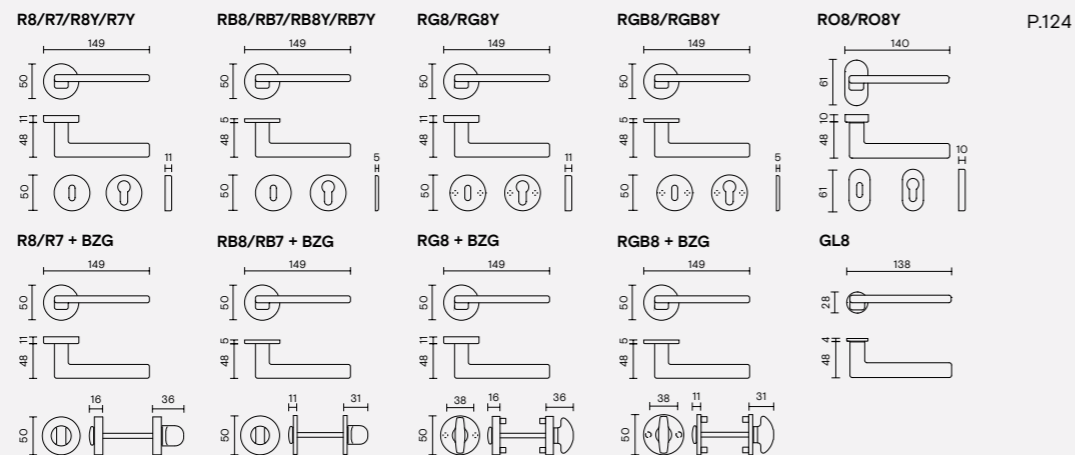

H 1044 U
Vincent Van Duysen

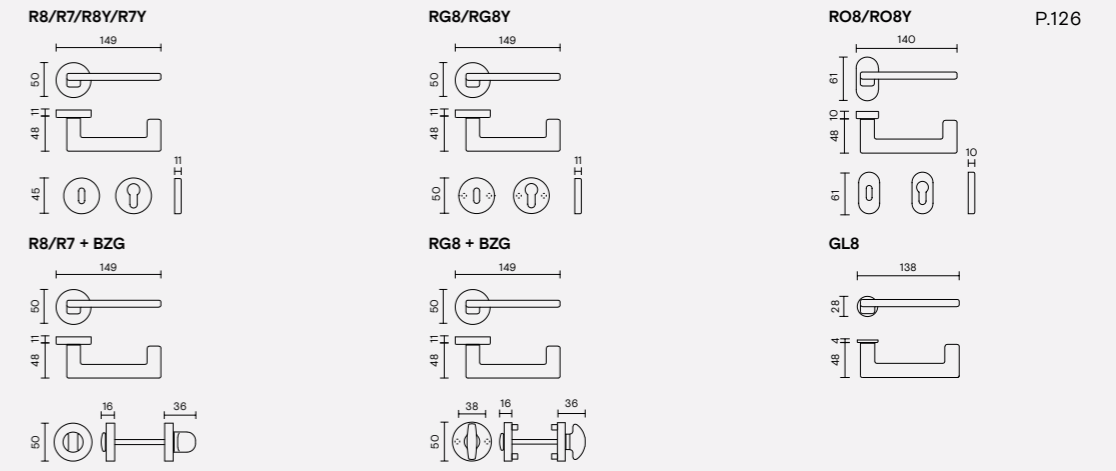

H 1044 Q
Vincent Van Duysen

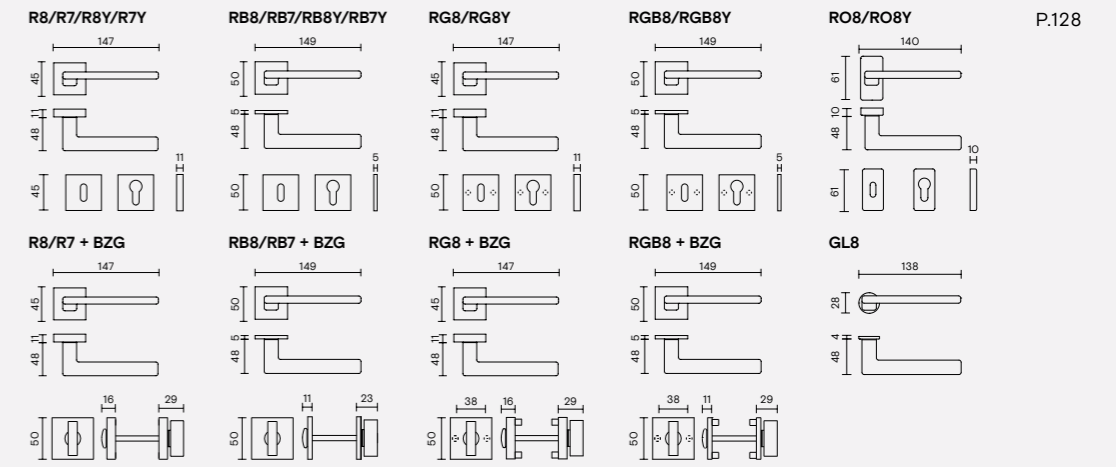

H 1044 U Q
Vincent Van Duysen

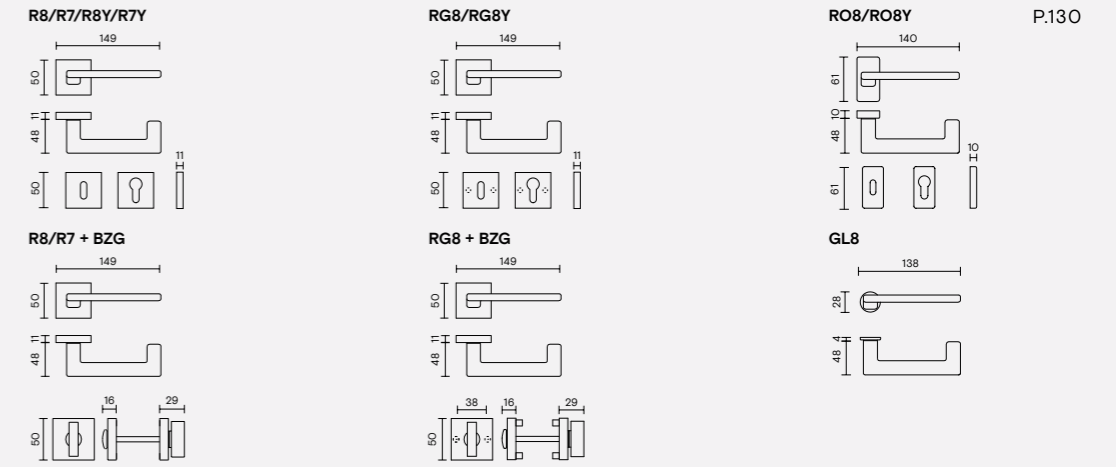

H 378
Yabu Pushelberg

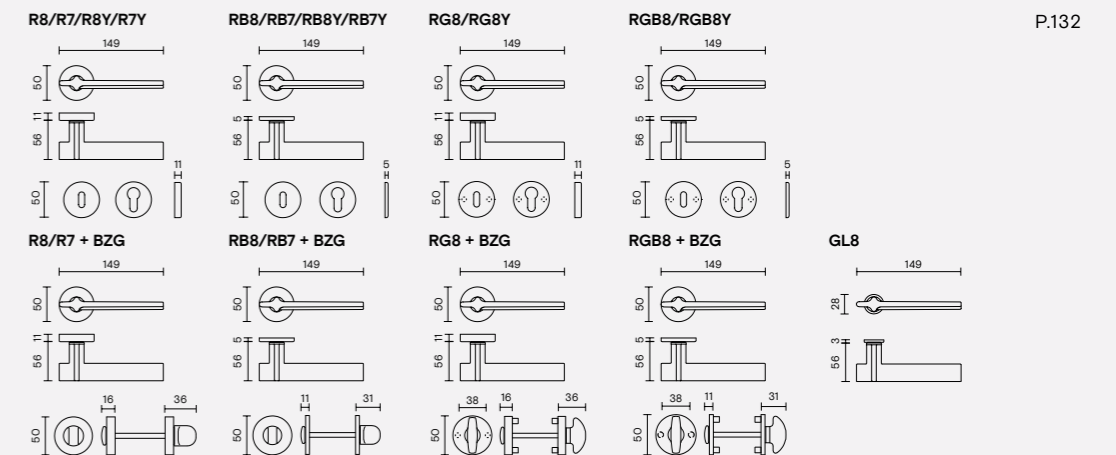

H 338
Yoshimi Kono

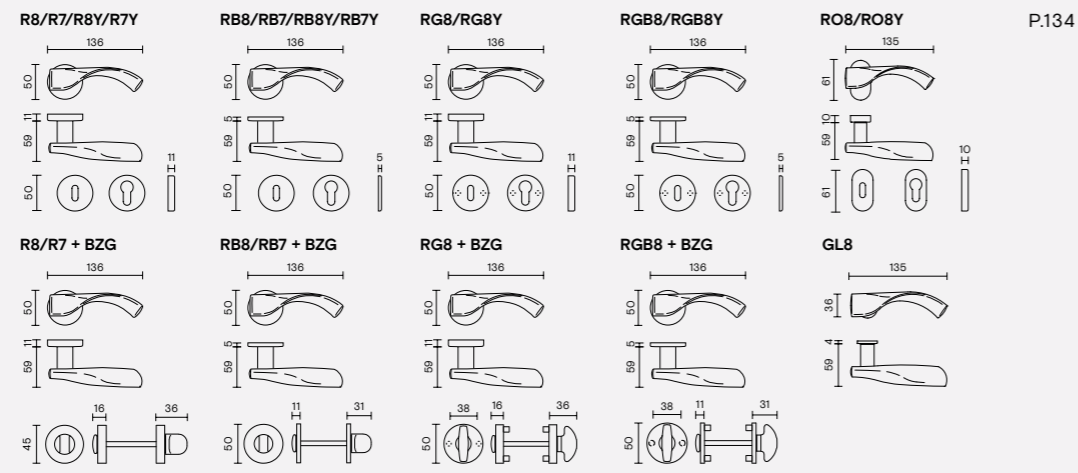

H 1045
Yoshimi Kono

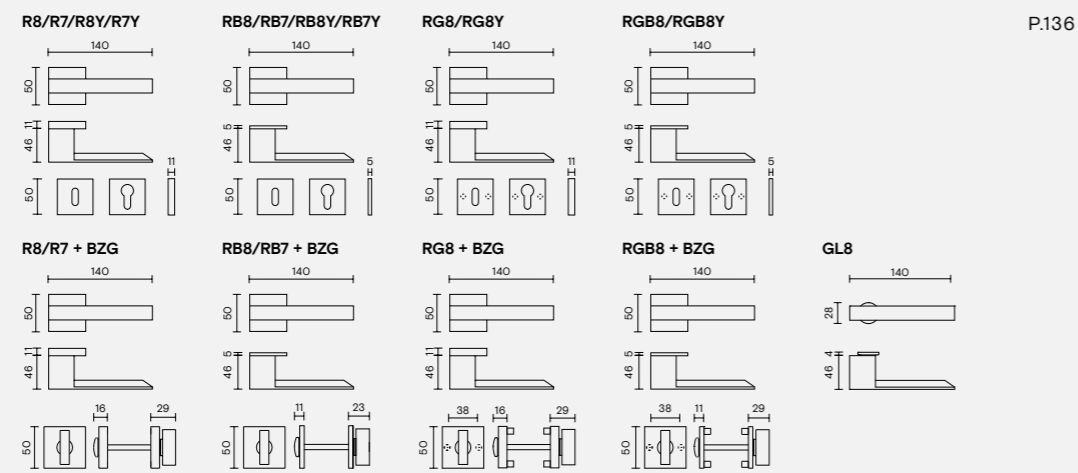

H 356
Zaha Hadid

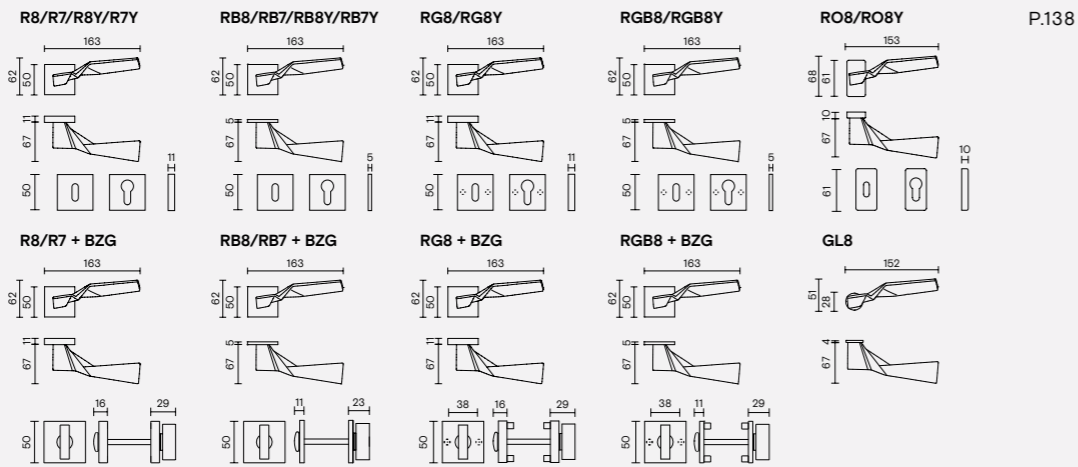

Disegni tecnici / Technical drawings

Lab

H 1058
Amica

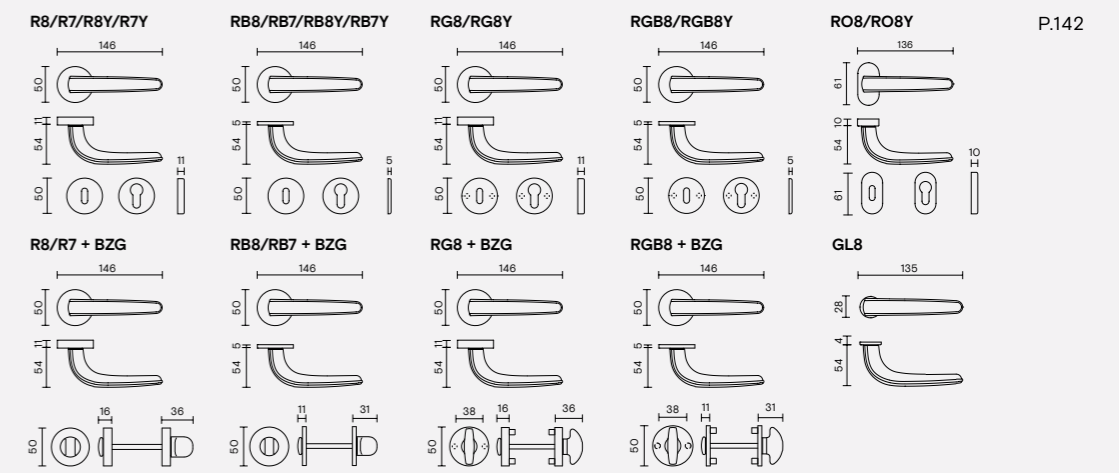

H 1004
Antares

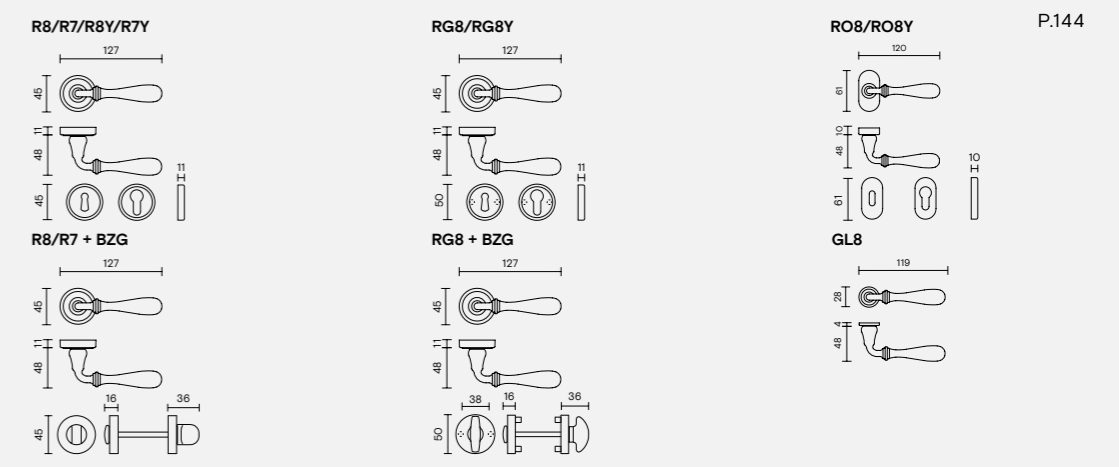

H 1062
Carmen

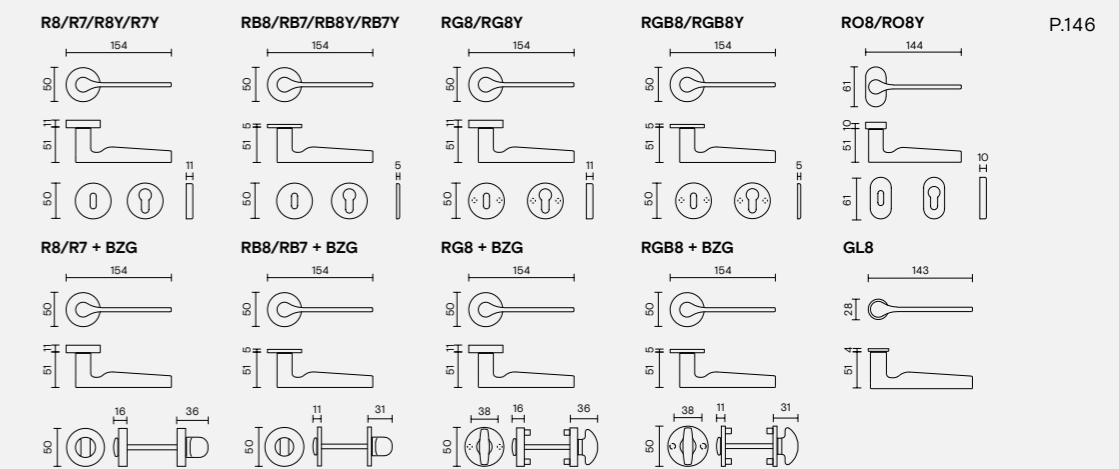

H 1027

Dafne



R8/R7/R8Y/R7Y

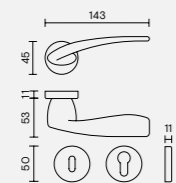

RG8/RG8Y

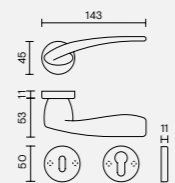

P.148

R8/R7 + BZG

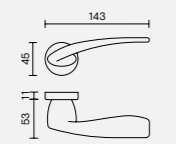

RG8 + BZG

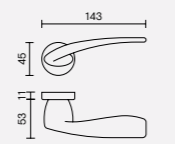

GL8

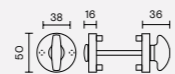
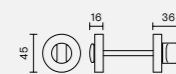
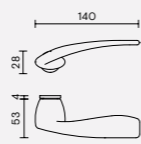

H 1049

Divara



R8/R7/R8Y/R7Y

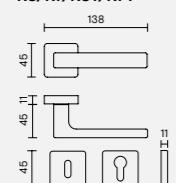

RB8/RB7/RB8Y/RB7Y

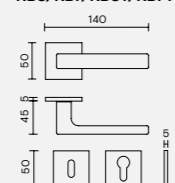

RG8/RG8Y

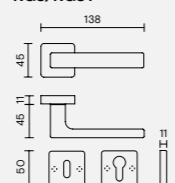

RGB8/RGB8Y

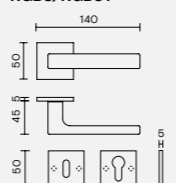

RO8/RO8Y

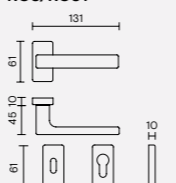

P.150

R8/R7 + BZG

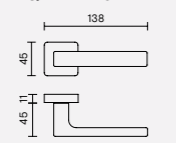

RB8/RB7 + BZG

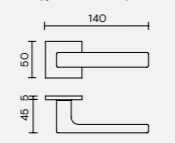

RG8 + BZG

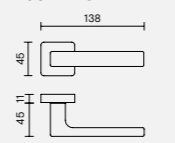

RGB8 + BZG

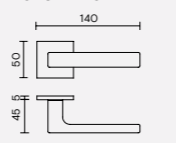

GL8

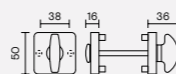
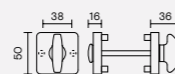
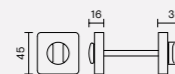
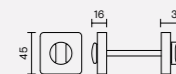
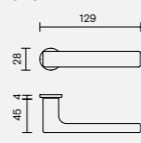

H 1049 T

Divara



R8/R7/R8Y/R7Y

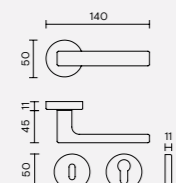

RB8/RB7/RB8Y/RB7Y

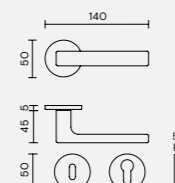

RG8/RG8Y

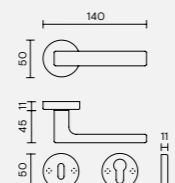

RGB8/RGB8Y

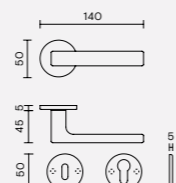

RO8/RO8Y

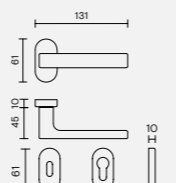

P.152

R8/R7 + BZG

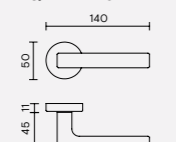

RB8/RB7 + BZG

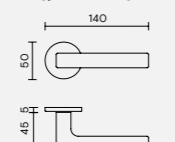

RG8 + BZG

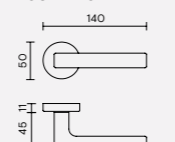

RGB8 + BZG

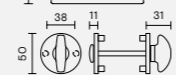
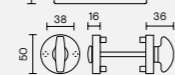
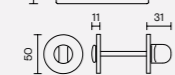
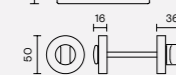
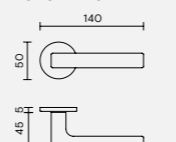

H 1022

Ernani



R8/R7/R8Y/R7Y

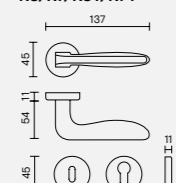

RB8/RB7/RB8Y/RB7Y

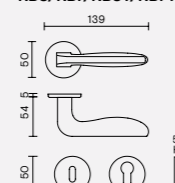

RG8/RG8Y

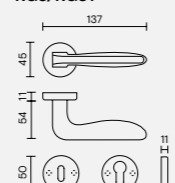

RGB8/RGB8Y

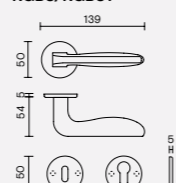

RO8/RO8Y

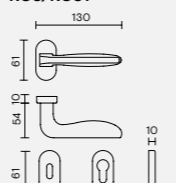

P.154

R8/R7 + BZG

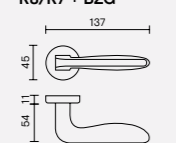

RB8/RB7 + BZG

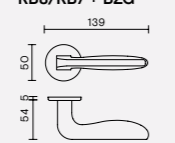

RG8 + BZG

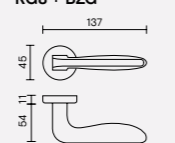

RGB8 + BZG

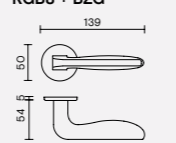

GL8

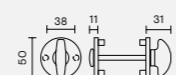
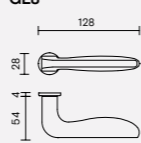

H 165

Germana



R8/R7/R8Y/R7Y

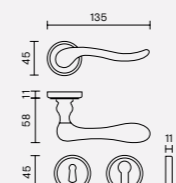

RG8/RG8Y

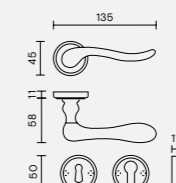

RO8/RO8Y

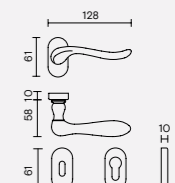

P.156

R8/R7 + BZG

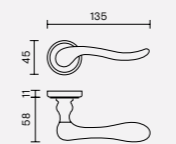

RG8 + BZG

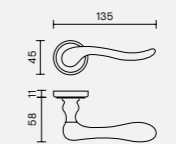

GL8

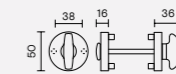
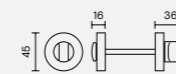
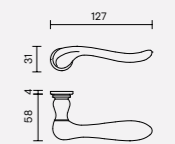

H 1050

Giasone



R8/R7/R8Y/R7Y

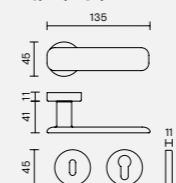

RB8/RB7/RB8Y/RB7Y

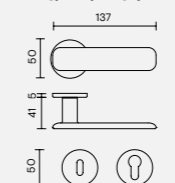

RG8/RG8Y

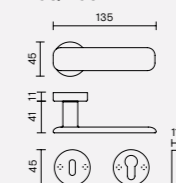

RGB8/RGB8Y

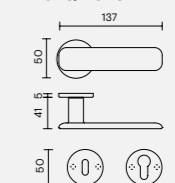

RO8/RO8Y

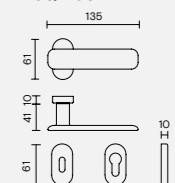

P.158

R8/R7 + BZG

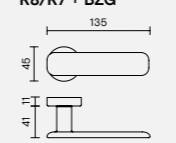

RB8/RB7 + BZG

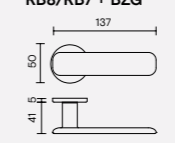

RG8 + BZG

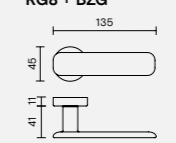

RGB8 + BZG

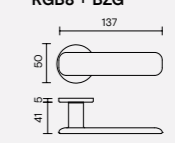

GL8

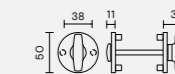
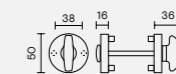
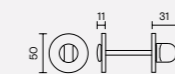
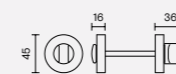
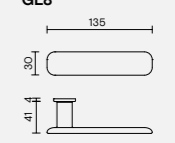

H 1024

Lolita



R8/R7/R8Y/R7Y

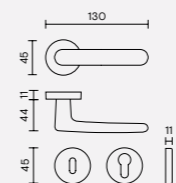

RB8/RB7/RB8Y/RB7Y

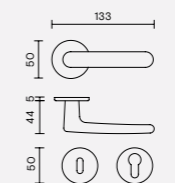

RG8/RG8Y

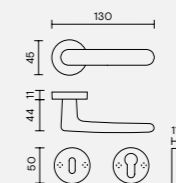

RGB8/RGB8Y

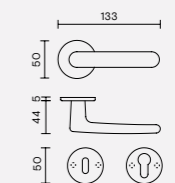

RO8/RO8Y

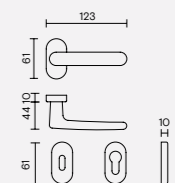

P.160

R8/R7 + BZG

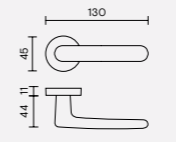

RB8/RB7 + BZG

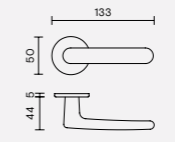

RG8 + BZG

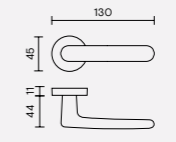

RGB8 + BZG

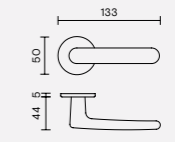

GL8

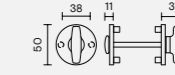
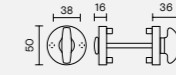
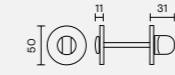
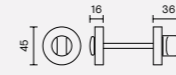
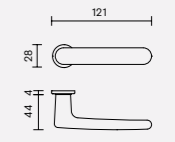

H 123

Luigi XVI



R8/R7/R8Y/R7Y

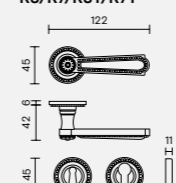

RG8/RG8Y

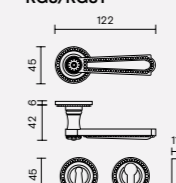

P.162

R8/R7 + BZG

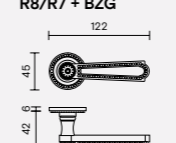

RG8 + BZG

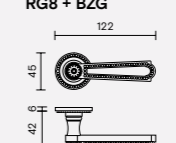

GL8

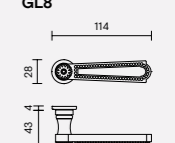

H 1016
Nabucco



R8/R7/R8Y/R7Y

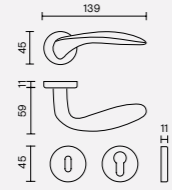

R8/R7 + BZG

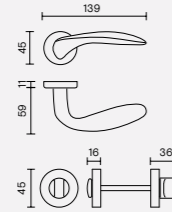

RG8/RG8Y

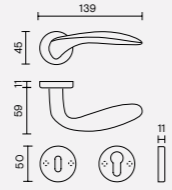

RG8 + BZG

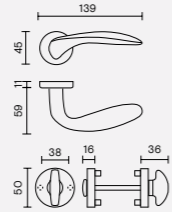

RO8/RO8Y

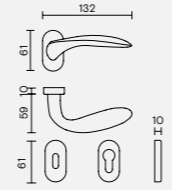

GL8

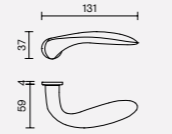

P.164

H 1064
Naked



RB8/RB7/RB8Y/RB7Y

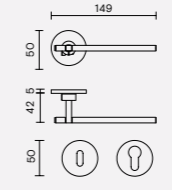

RB8/RB7 + BZG

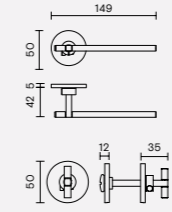

RGB8/RGB8Y

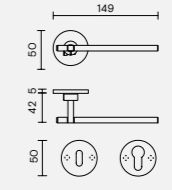

RGB8 + BZG

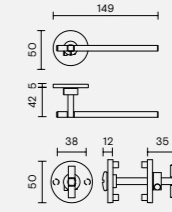

GL8

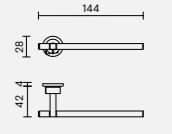

P.170

H 1046
Nais



R8/R7/R8Y/R7Y

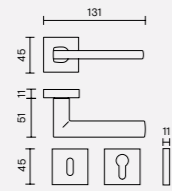

R8/R7 + BZG

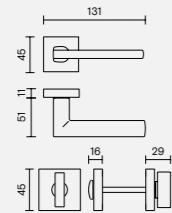

RB8/RB7/RB8Y/RB7Y

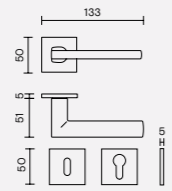

RB8/RB7 + BZG

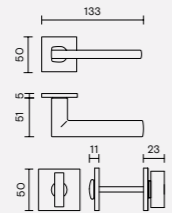

RG8/RG8Y

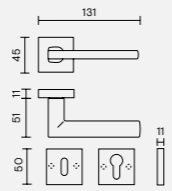

RG8 + BZG

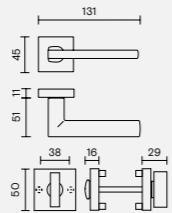

RGB8/RGB8Y

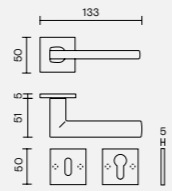

RGB8 + BZG

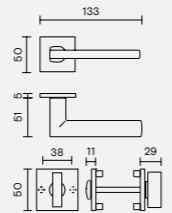

RO8/RO8Y

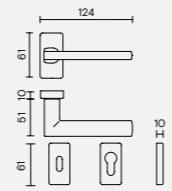

GL8

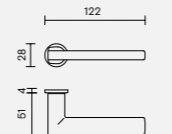

P.166

H 192
Prunus



R8/R7/R8Y/R7Y

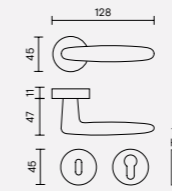

R8/R7 + BZG

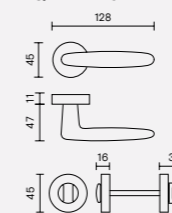

RB8/RB7/RB8Y/RB7Y

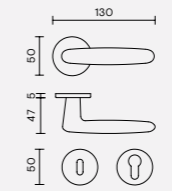

RB8/RB7 + BZG

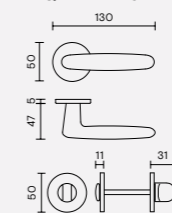

RG8/RG8Y

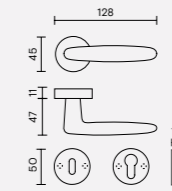

RG8 + BZG

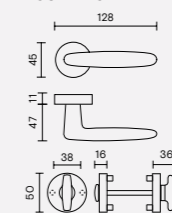

RGB8/RGB8Y

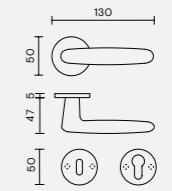

RGB8 + BZG

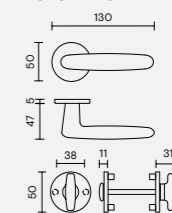

RO8/RO8Y

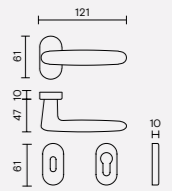

GL8

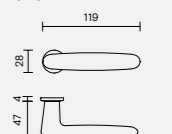

P.174

H 1046 T
Nais



R8/R7/R8Y/R7Y

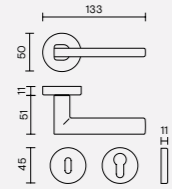

R8/R7 + BZG

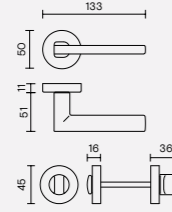

RB8/RB7/RB8Y/RB7Y

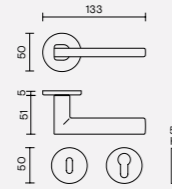

RB8/RB7 + BZG

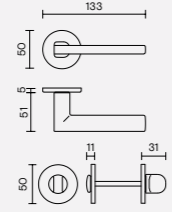

RG8/RG8Y

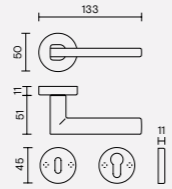

RG8 + BZG

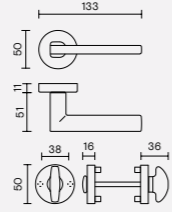

RGB8/RGB8Y

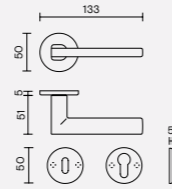

RGB8 + BZG

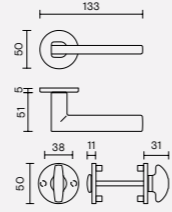

RO8/RO8Y

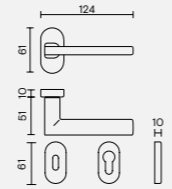

P.168

H 1056
Quadra



R8/R7/R8Y/R7Y

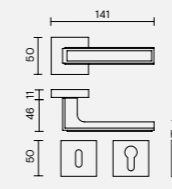

R8/R7 + BZG

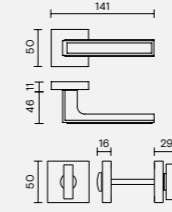

RB8/RB7/RB8Y/RB7Y

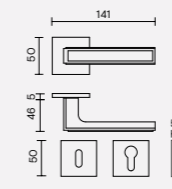

RB8/RB7 + BZG

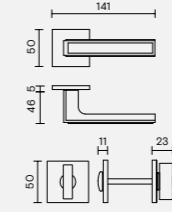

RG8/RG8Y

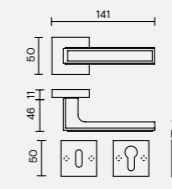

RG8 + BZG

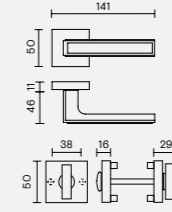

RGB8/RGB8Y

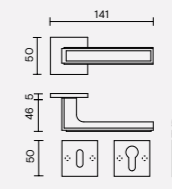

RGB8 + BZG

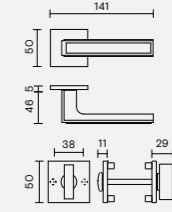

RO8/RO8Y

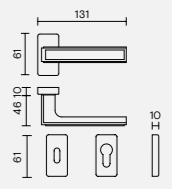

GL8

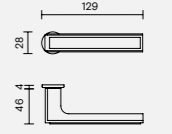

P.178

H 1065
Naked Due



RB8/RB7/RB8Y/RB7Y

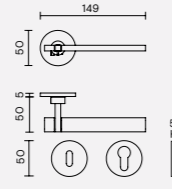

RB8/RB7 + BZG

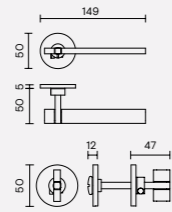

RGB8/RGB8Y

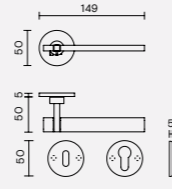

RGB8 + BZG

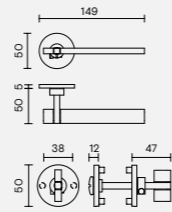

GL8

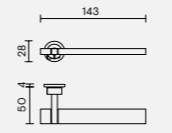

P.172

H 1056 T
Quadra



R8/R7/R8Y/R7Y

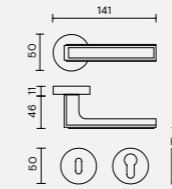

R8/R7 + BZG

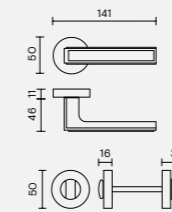

RB8/RB7/RB8Y/RB7Y

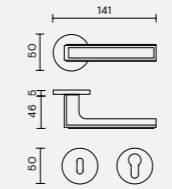

RB8/RB7 + BZG

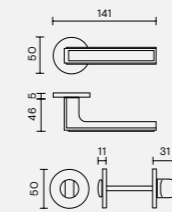

RG8/RG8Y

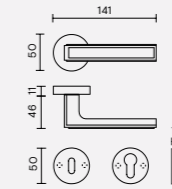

RG8 + BZG

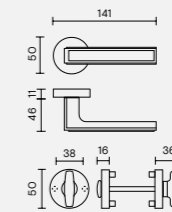

RGB8/RGB8Y

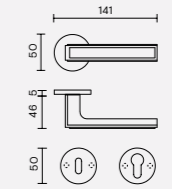

RGB8 + BZG

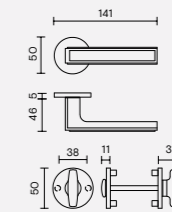

RO8/RO8Y

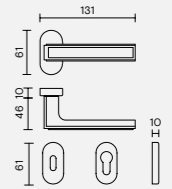

P.176

H 1057

Retrò



R8/R7/R8Y/R7Y

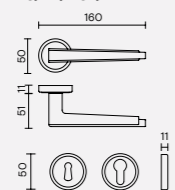

R8/R7 + BZG

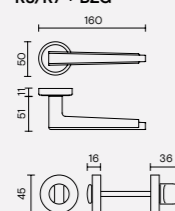

RG8/RG8Y

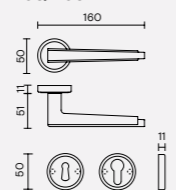

RG8 + BZG

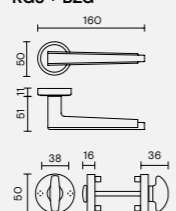

RO8/RO8Y

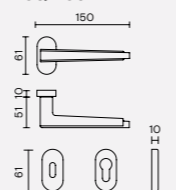

GL8

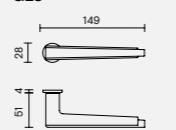

P.180

H 1037

Teseo



R8/R7/R8Y/R7Y

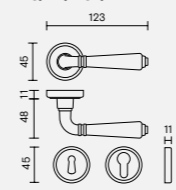

R8/R7 + BZG

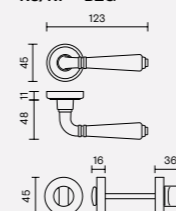

RG8/RG8Y

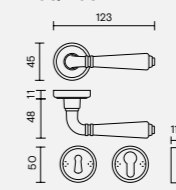

RG8 + BZG

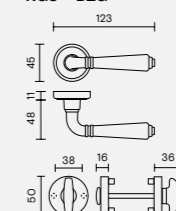

RO8/RO8Y

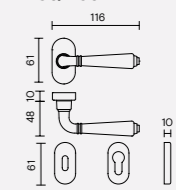

GL8

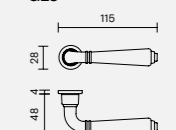

P.188

H 1067

Rose



R8/R7/R8Y/R7Y

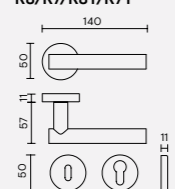

R8/R7 + BZG

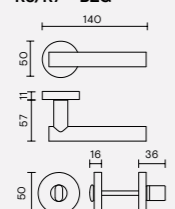

RG8/RG8Y

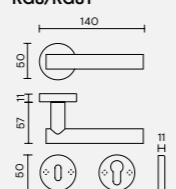

RG8 + BZG

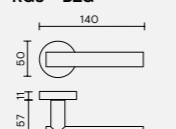

P.182

H 1054

W.W.



R8/R7/R8Y/R7Y

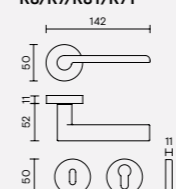

R8/R7 + BZG

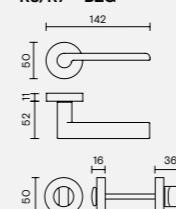

RB8/RB7/RB8Y/RB7Y

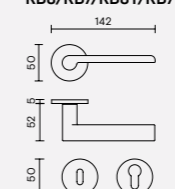

RB8/RB7 + BZG

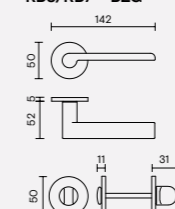

RG8/RG8Y

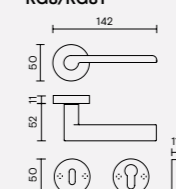

RG8 + BZG

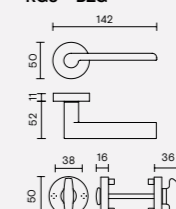

RGB8/RGB8Y

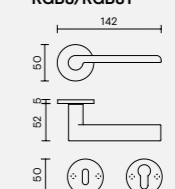

RGB8 + BZG

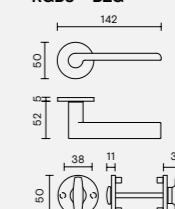

RO8/RO8Y

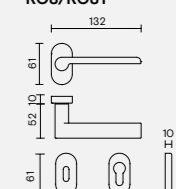

GL8

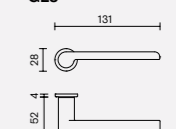

P.190

H 163

Sarissa



R8/R7/R8Y/R7Y

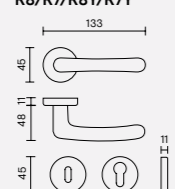

R8/R7 + BZG

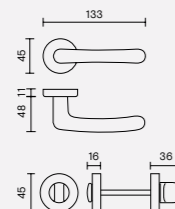

RB8/RB7/RB8Y/RB7Y

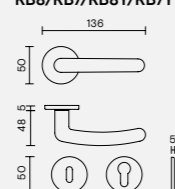

RB8/RB7 + BZG

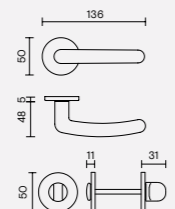

RG8/RG8Y

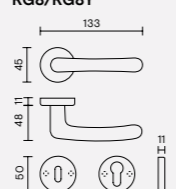

RG8 + BZG

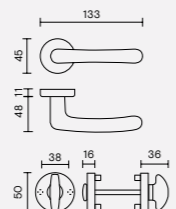

RGB8/RGB8Y

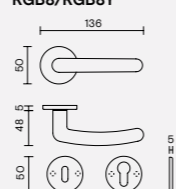

RGB8 + BZG

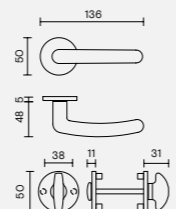

RO8/RO8Y

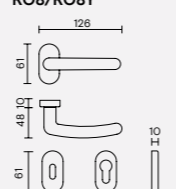

GL8

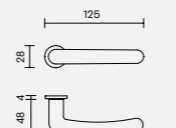

P.184

H 414

Amber



R8/R7/R8Y/R7Y

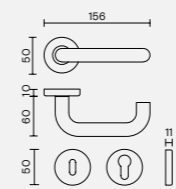

R8/R7 + BZG

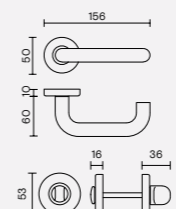

RG8/RG8Y

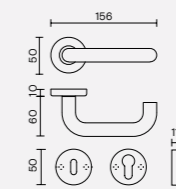

RG8 + BZG

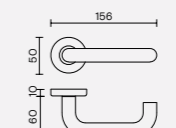

RO8/RO8Y

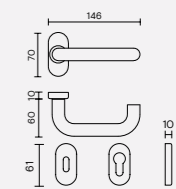

GL8

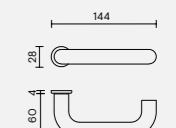

P.192

H 176

Spiga



R8/R7/R8Y/R7Y

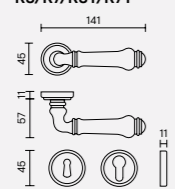

R8/R7 + BZG

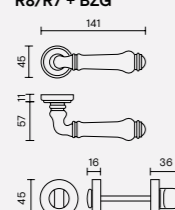

RG8/RG8Y

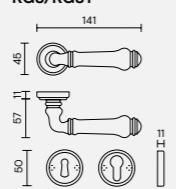

RG8 + BZG

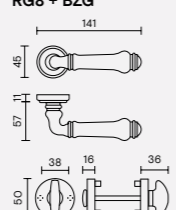

RO8/RO8Y

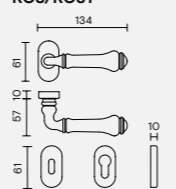

GL8

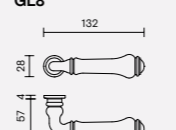

P.186

H 419

Bordeaux

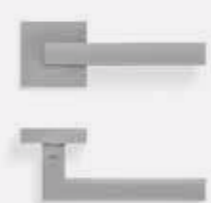

R8/R7/R8Y/R7Y

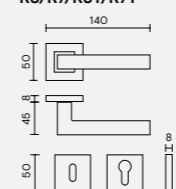

R8/R7 + BZG

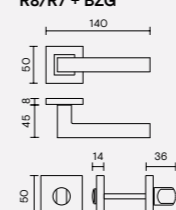

RO8/RO8Y

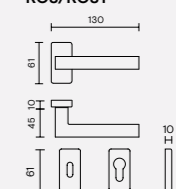

GL8

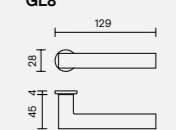

P.194

H 416
Garnet

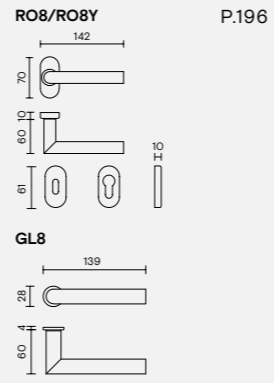
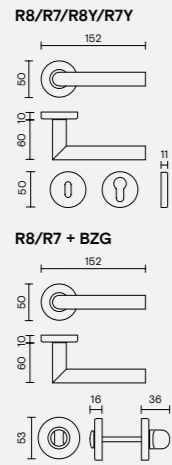

P.196

H 411
Leila

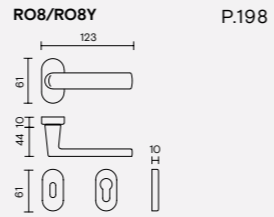
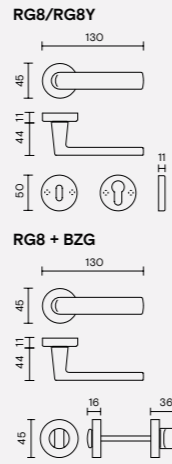
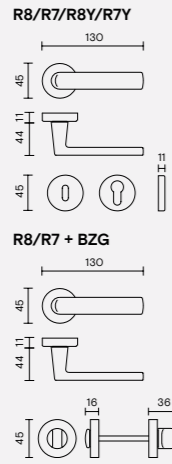

P.198

H 411 Q
Leila

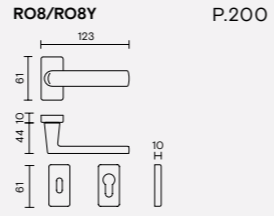
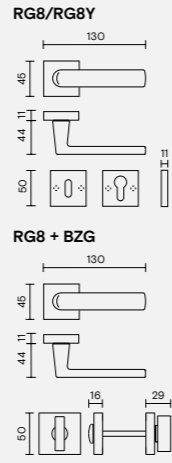
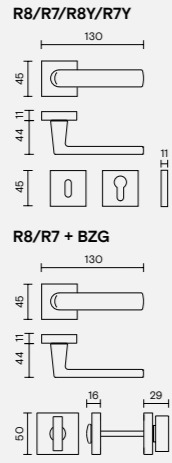

P.200



Legenda codici di indentificazione articoli

Article identification codes

<p>Numerazione articolo Article number</p> <hr/> <h1 style="margin: 0;">H 1068 R8</h1>	<p>Tipologia prodotto Product type</p>	<p>Parametri di indentificazione articolo Article identification parameters</p>
--	--	---

H	Maniglie per porte e finestre Door handles and window handles
K	Pomoli / Door knobs Maniglioni / Pull handles Alzanti scorrevoli / Lift and slide handles Bocchette / Escutcheons Chiusure privacy BZG / Bathroom privacy sets Porta abiti - Ganci / Coat hooks - Hooks
X	Complementari e sistemi di fissaggio Complementary accessories and fixing system

Descrizione parametri di indentificazione articolo

Description of article identification parameters

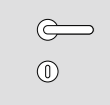
	<p>R _</p> <p>Articolo con rosetta, molla di ritorno e sottorosetta con viti a legno, quadro 7 o 8 mm, bocchetta con foro chiave normale. Article on rosettes with return spring and anchor rose with wooden screws, 7 or 8 mm spindle, with standard escutcheon.</p>
---	---

	<p>RB _ Y</p> <p>Articolo con rosetta fine, molla di ritorno e sottorosetta con viti a legno, quadro 7 o 8 mm, bocchetta fine con foro chiave cilindro. Article on slim rosettes with return spring and anchor rose with wooden screws, 7 or 8 mm spindle, with cylinder slim escutcheon.</p>
---	---

	<p>RB _</p> <p>Articolo con rosetta fine, molla di ritorno e sottorosetta con viti a legno, quadro 7 o 8 mm, bocchetta con foro chiave normale. Article on slim rosettes with return spring and anchor rose with wooden screws, 7 or 8 mm spindle, with standard escutcheon.</p>
--	--

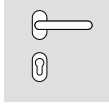
	<p>RO8</p> <p>Articolo con rosetta stretta, molla di ritorno e sottorosetta con viti a legno, quadro 8 mm, bocchetta stretta con foro chiave normale. Article on narrow rose, with return spring, anchor rose with wooden screw, 8 mm spindle narrow escutcheon with normal key hole.</p>
---	---

	<p>RR _ R</p> <p>Maniglia destra senza rosetta. Right handle without rosette.</p>
--	---

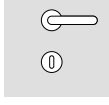
	<p>RO8 _ Y</p> <p>Articolo con rosetta stretta, molla di ritorno e sottorosetta con viti a legno, quadro 8 mm, bocchetta stretta con foro chiave cilindro. Article on narrow rose, with return spring, anchor rose with wooden screw, 8 mm spindle narrow escutcheon with cylinder key hole.</p>
---	--

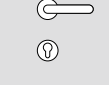
	<p>RR _ L</p> <p>Maniglia sinistra senza rosetta. Left handle without rosette.</p>
--	--

	<p>RG _</p> <p>Articolo con rosetta, molla di ritorno, sottorosetta con perni per viti passanti, quadro 8 o 8,5 mm, bocchetta con foro chiave normale. Article on rosettes with return spring and anchor rose for bolt through fixing, 8 or 8,5 mm spindle, with standard escutcheon.</p>
---	---

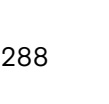
	<p>R _ Y</p> <p>Articolo con rosetta, molla di ritorno, sottorosetta con viti a legno, quadro 7 o 8 mm, bocchetta con foro chiave cilindro. Article on rosettes with return spring and anchor rose with wooden screws, 7 or 8 mm spindle, with cylinder escutcheon.</p>
--	---

	<p>RGB _</p> <p>Articolo con rosetta fine, molla di ritorno, sottorosetta con perni per viti passanti, quadro 8 o 8,5 mm, bocchetta fine con foro chiave normale. Article on slim rosettes with return spring and anchor rose for bolt through fixing, 8 or 8,5 mm spindle, with standard slim escutcheon.</p>
---	--

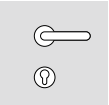
	<p>RG _ Y</p> <p>Articolo con rosetta, molla di ritorno, sottorosetta con perni per viti passanti, quadro 8 o 8,5 mm, bocchetta con foro chiave cilindro. Article on rosettes with return spring and anchor rose for bolt through fixing, 8 or 8,5 mm spindle, with cylinder escutcheon.</p>
--	--

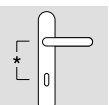
	<p>RGB _ Y</p> <p>Articolo con rosetta fine, molla di ritorno, sottorosetta con perni per viti passanti, quadro 8 o 8,5 mm, bocchetta fine con foro chiave cilindro. Article on slim rosettes with return spring and anchor rose for bolt through fixing, 8 or 8,5 mm spindle, with cylinder escutcheon.</p>
---	--

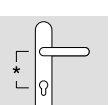
	<p>P _ 70</p> <p>Articolo con placca, quadro 7-8-8,5 mm, foro chiave normale. Il numero 70, indicato a titolo di esempio, che è variabile e dipende dalle normative di ogni mercato, indica l'interasse in mm tra foro chiave e foro maniglia. Article on plate, 7-8-8,5 mm spindle, standard keyhole. The number "70" shown is variable and depends on the requirements of each individual market. It indicates distance between the spindle and keyhole centre in mm.</p>
---	---

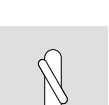
	<p>P _ Y85</p> <p>Articolo con placca, quadro 7-8-8,5 mm, foro chiave cilindro. Il numero 85, indicato a titolo di esempio, che è variabile e dipende dalle normative di ogni mercato, indica l'interasse in mm tra foro chiave e foro maniglia. Article on plate, 7-8-8,5 mm spindle, cylinder keyhole. The number "85" shown is variable and depends on the requirements of each individual market. It indicates distance between the spindle and keyhole centre in mm.</p>
---	---

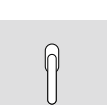
	<p>F</p> <p>Maniglia per finestra. Window handle.</p>
---	--

	<p>F RS</p> <p>Maniglia per finestra con movimento DRY-KEEP 4 e/o 8 scatti, disponibile con lunghezza quadro 27-30-35-41-45-50 mm. Window handle with DRY-KEEP movement, 4/8 click positions, available with spindle lengths 27-30-35-41-45-50 mm.</p>
---	--

	<p>F RS B</p> <p>Maniglia per finestra con movimento DRY-KEEP 8 scatti, su rosetta fine disponibile con lunghezza 41 mm. Window handle with DRY-KEEP movement, 8 click positions on slim rosette, available with 41 mm spindle length.</p>
---	--

	<p>RS 6-7-8 BZG</p> <p>Chiusura privacy, quadro disponibile 6-7-8 mm e lunghezza 75-85 mm, sottorosetta con viti a legno. Bathroom privacy set, 6-7-8 mm diameter spindle with length of 75-85 mm. Anchor rose with wood screws.</p>
--	--

	<p>RG 6-7-8 BZG</p> <p>Chiusura privacy, quadro disponibile 6-7-8 mm e lunghezza 75-85 mm, sottorosetta con viti passanti. Bathroom privacy set, 6-7-8 mm diameter spindle with length of 75-85 mm. Anchor rose with through screws.</p>
---	--

	<p>RS 6-7-8 BZG</p> <p>Chiusura privacy, quadro disponibile 6-7-8 mm e lunghezza 75-85 mm, sottorosetta con viti a legno, con indicatore libero/occupato. Bathroom privacy set, 6-7-8 mm diameter spindle with length of 75-85 mm. Anchor rose with wood screws. Vacant/engaged indicator.</p>
---	--

	<p>RSG 6-7-8 BZG</p> <p>Chiusura privacy, quadro disponibile 6-7-8 mm e lunghezza 75-85 mm, sottorosetta con viti passanti, con indicatore libero/occupato. Bathroom privacy set, 6-7-8 mm diameter spindle with length of 75-85 mm. Anchor rose with through screws. Vacant/engaged indicator.</p>
---	---

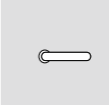
	<p>GL</p> <p>Maniglia per serratura porte vetro. Door handle suitable for glass door locks.</p>
---	---

Per le versioni disponibili fare riferimento al listino-prezzi in vigore nel Paese di appartenenza.
To see the available versions, please refer to the price-list in force in each Country.

Sistemi di fissaggio / Fixing versions available



Scopri le istruzioni su Valli Academy
Find out the instruction on Valli Academy

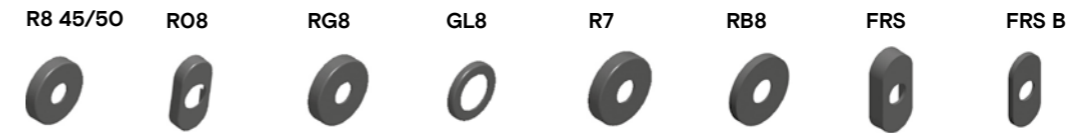

Scopri i video tutorial di

Valli.Academy

Lo spazio virtuale dedicato alla formazione tecnica per la corretta installazione dei prodotti Valli.

Discover our video tutorials on Valli.Academy
The virtual space dedicated to technical training for the correct installation of Valli products.



Inquadrando il QR sarà possibile navigare la pagina e scoprire le tecnologie brevettate per il montaggio di una maniglia in pochi minuti.
Framing the QR will allow you to navigate the page and discover the patented technologies for fitting a handle in a few minutes.

R8 45 / 50

Molla / Spring **R8 45/50 - Rosetta da 45 a 50 (8mm)**
R8 45/50 - Anchor rose with wooden screws (8mm spindle)

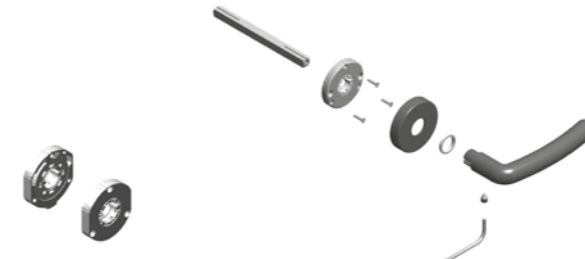

R08

Molla / Spring **R08 - Rosetta stretta (8mm) / R08 - Narrow anchor rose with wooden screws (8mm spindle)**

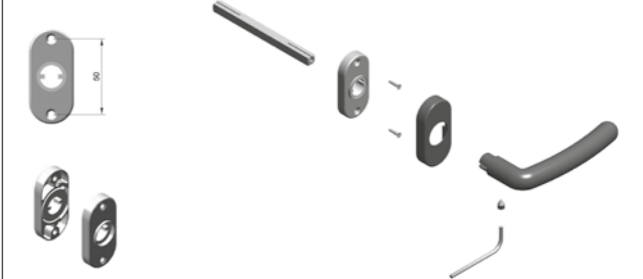

R7

Molla / Spring **R7 45/50 - Rosetta da 45 a 50 (7mm)**
R7 - Anchor rose with wooden screws (7mm spindle)

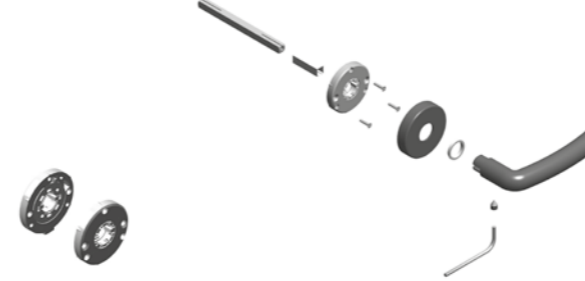

GL 8

Molla / Spring **GL8 - Rosetta porte vetro (8mm)**
GL8 - Anchor rose for glass door (8mm spindle)

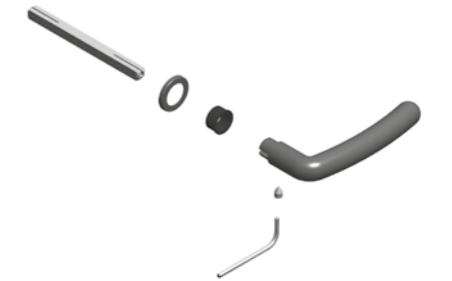

RG8

Molla / Spring **RG8 - Rosetta da 50 e sottocostruzioni con viti passanti (8mm / 8,5mm) / RG8 - Anchor rose for bolt through fixing (8mm / 8.5mm)**

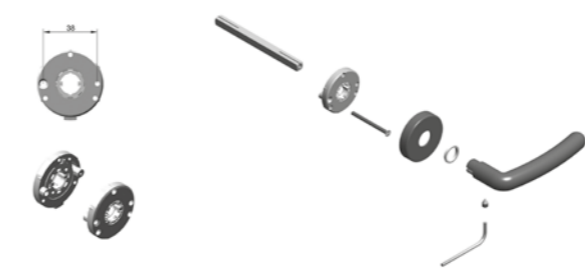

FRS

Molla / Spring **FRS - Movimento 4 scatti (disponibile anche in 8 scatti) / FRS - 4 clicks position movement (8 click position also available)**



RB8

Molla / Spring **RB8 - Rosetta fine 50 mm**
RB8 - 50 mm slim rosette

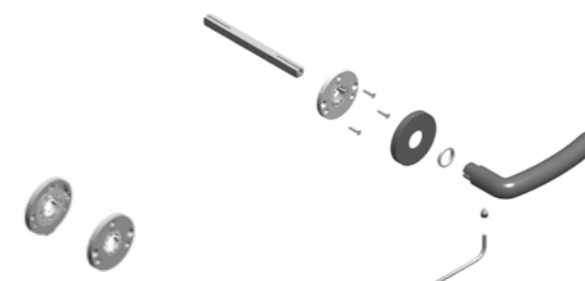

FRS B

Molla / Spring **FRS B - Movimento 8 scatti su rosetta fine**
FRS B - 8 clicks position movement on slim rosette





**Sistema di Gestione Ambientale
ai sensi della Norma UNI EN ISO
14001:2015**

Environmental Management according
to UNI EN ISO 14001:2015



**Sistema di Gestione Qualità
ai sensi della Norma UNI EN ISO
9001:2015**

Quality Management according
to UNI EN ISO 9001:2015



**Certificazione di prodotto
Norma Europea EN 1906:2012**

European Norm EN 1906:2012
Product certification



**Certificazione Antifuoco
Attestato di resistenza al fuoco
secondo EN 1634-1:2018**

Certificate of fire resistant and smoke
control EN 1634-1:2018

Norma Europea EN 1906:2012

European Norm EN 1906:2012

4 7 - B O - O B

1 2 3 4 5 6 7 8

1	Categoria di utilizzo / Category of use
1	<p>Classe 1: Utilizzo di media frequenza delle guarniture, da parte di persone che sostanzialmente esercitano un utilizzo accurato e presentano un rischio ridotto per quanto riguarda l'uso non corretto (ad esempio per le porte interne di abitazioni). Class 1: Medium frequency of use by people with a high incentive to exercise care and with a small chance of misuse, e.g. internal residential doors.</p>
2	<p>Classe 2: Utilizzo di media frequenza delle guarniture, da parte di persone che esercitano un utilizzo sostanzialmente accurato ma che presentano un certo rischio per quanto riguarda l'uso non corretto (ad esempio per le porte interne di uffici). Class 2: Medium frequency of use by people with some incentive to exercise care but where there is some chance of misuse, e.g. internal office doors.</p>
3	<p>Classe 3: Utilizzo ad elevata frequenza delle guarniture, da parte del pubblico o di altre persone, che non hanno particolare cura nell'uso e per le quali esiste un notevole rischio d'utilizzo errato (ad esempio per le porte di edifici pubblici notevolmente frequentati). Class 3: High frequency of use by public or others with little incentive to exercise care and with a high chance of misuse, e.g. public office doors.</p>
4	<p>Classe 4: Per impiego su porte che vengono azionate spesso e con forza (porte in stadi di calcio, su piattaforme petrolifere, nelle caserme, toilette pubbliche, ...). Class 4: High frequency of use on doors which are subject to frequent violent usage, e.g. football stadiums, offshore installations (oil rigs), barracks, public toilets, etc.</p>
2	Resistenza di durata / Durability
6	100.000 cicli di prova/test runs
7	200.000 cicli di prova/test runs
3	Massa della porta / Door mass
-	-
4	Resistenza al fuoco / Fire resistance
O	non ammissibile per porte tagliafuoco o antifumo not allowed for fire doors or anti-smoking doors
B	adatta per porte tagliafuoco e antifumo suitable for fire and anti-smoking door

5	Sicurezza personale / Safety
0	per uso normale / for normal use
1	per uso con requisiti di sicurezza for use with safety requirements
6	Resistenza alla corrosione / Corrosion resistance
0	nessuna resistenza definita alla corrosione no corrosion resistance
1	ridotta resistenza alla corrosione low corrosion resistance
2	media resistenza alla corrosione medium corrosion resistance
3	alta resistenza alla corrosione high corrosion resistance
4	resistenza molto elevata alla corrosione very high corrosion resistance
5	resistenza estremamente elevata alla corrosione extreme corrosion resistance
7	Sicurezza contro lo scasso / Security
0	nessuna resistenza contro eventuale scasso no resistance against possible forced entry
1	ridotta resistenza allo scasso low resistance against possible forced entry
2	media resistenza allo scasso medium resistance against possible forced entry
3	alta resistenza allo scasso high resistance against possible forced entry
4	resistenza molto elevata allo scasso very high resistance against possible forced entry
8	Tipo di azionamento / Type of operation
A	con molla / with spring
B	con precarico a molla / with spring preload
C	senza molla / without spring

Finiture e grado di resistenza alla corrosione (Digit 6 EN 1906:2012)

Finishes and corrosion resistance (Digit 6 EN 1906:2012)

Grado / Grade	Finiture / Finishes
1	Brunito/Burnished
2	Orsatop/Matt brass, Anticato/Antique, Nikelnero/Black nickel, Bronzop/Matt bronze, Bronzo scuro/Dark bronze
3	Ottone antico/Antique brass
4	Acciaio inox 304 lucido/Polished 304 stainless steel, Acciaio inox 304 satinato/Satin 304 stainless steel, Orolucido/Polished brass, Orsatin/Satin brass, Nickel, Nikmatt, Bronzsat, Neropaco/Matt black, Biancopaco/Matt white, Light black
5	Acciaio inox 316 lucido/Polished 316 stainless steel, Acciaio inox 316 satinato/Satin 316 stainless steel, Orolucido PVD/Polished brass PVD, Orsatin PVD/Satin brass PVD, Cromo/Polished chrome, Cromo PVD/Polished chrome PVD, Cromosat/Satin chrome, Cromosat PVD/Satin chrome PVD, Titanium PVD

Alcune finiture presentano un grado di delicatezza maggiore, possono mostrare una non uniformità della sfumatura e tonalità e sono soggette a naturale usura, con alterazione dell'aspetto o deterioramento nel tempo, talvolta rilevando il colore dell'ottone sottostante. Le maniglie con inserti in pelle, ceramica, legno o metallo possono presentare leggere imperfezioni dovute all'assemblaggio manuale del prodotto finito oltre ad essere soggette ad una naturale usura legata alla natura dello stesso materiale, con alterazione dell'aspetto, del colore o deterioramento nel tempo.

Some finishes are more delicate than others, may appear uneven in nuance and tone and are subject to natural wear and tear. The product may change in appearance or deteriorate over time, sometimes revealing the underlying brass. Handles with leather, ceramic, wood, or metal inserts may show slight imperfections due to the manual assembly process and are subject to normal wear and tear related to the material itself. The product may change in appearance and colour or deteriorate over time.



Maniglie classe 4 (EN 1906:2012)

Class 4 lever handles (EN 1906:2012)

Classe 4: Per impiego su porte che vengono azionate spesso e con forza (porte in stadi di calcio, su piattaforme petrolifere, nelle caserme, toilette pubbliche, ...).
Class 4: High frequency of use on doors which are subject to frequent violent usage, e.g. football stadiums, offshore installations (oil rigs), barracks, public toilets, etc.

Durabilità Durability	Oltre 200.000 cicli di apertura Over 200.000 opening cycles	Resistenza al fuoco Fire resistance	Resistenza al fumo Smoke resistance	Elevata resistenza alla corrosione High resistance to corrosion	Con molla di ritorno With return spring
--------------------------	--	---	--	--	---

H 384	CetraRuddy Architecture D.P.C.	p. 22	H 327	Antonio Citterio	p. 70	H 1044 U Q	Vincent Van Duysen	p. 121
H 382	Joe Cheng	p. 26	H 317	Antonio Citterio	p. 72	H 1039	Jean-Baptiste Sibertin Blanc	p. 126
H 381	Khalid Al Najjar	p. 28	H 311	Mario Bellini	p. 76	H 1027	Dafne	p. 130
H 378	Yabu Pushelberg	p. 34	H 5017	Hans Kollhoff	p. 78	H 1026	Antonio Bullo	p. 131
H 376	Giancarlo Vegni	p. 40	H 5015	Antonio Citterio	p. 79	H 1024	Lolita	p. 133
H 372	Eri Goshen	p. 42	H 1068	Pembroke & Ives	p. 82	H 1022	Ernani	p. 135
H 370	Doriana e Massimiliano Fuksas	p. 44	H 1062	Carmen	p. 89	H 1016	Nabucco	p. 137
H 368	Cerri & Associati	p. 46	H 1057	Retrò	p. 84	H 1003	Matteo Thun	p. 140
H 367	Giancarlo Vegni	p. 48	H 1054	W.W.	p. 95	H 198	Eero Aarnio	p. 143
H 364	Mario Bellini	p. 50	H 1052	Mikhail Leykin	p. 102	H 192	Prunus	p. 146
H 359	Skidmore, Owings & Merrill	p. 54	H 1050	Giasone	p. 104	H 165	Germana	p. 150
H 348	David Chipperfield	p. 58	H 1049	Divara	p. 108	H 163	Sarissa	p. 152
H 338	Yoshimi Kono	p. 62	H 1046	Nais	p. 112	Disponibile su richiesta Classe 4 anche sulle versioni R8 / CL4 / R8Y CL4 / RG8 CL4 / RG8Y CL4 secondo la norma EN 1906 - Digit 4 7 - O O - O B.		
H 334	Foster + Partners	p. 65	H 1045	Yoshimi Kono	p. 114	Upon request, Class 4 is also available on versions R8 / CL4 / R8Y CL4 / RG8 CL4 / RG8Y CL4 according to EN 1906 - Digit 4 7 - O O B.		
H 330	Matteo Thun	p. 66	H 1044 U	Vincent Van Duysen	p. 118			

Valli

Via Concordia, 16
20838 Renate (MB)
Italy

**Ufficio Commerciale
Italia**

+39 0362 982271
valli.italia@vallihandles.com

**Ufficio Commerciale
Export**

+39 0362 982260
valli.export@vallihandles.com

vallihandles.com

This catalogue is constantly updated. We reserve the right to make any changes to the products featured herein or to discontinue them without prior notice. Images, data, measurements, and technical drawings are for information only and are not to be considered binding. Please consult the vallihandles.com website for the latest updates on the Valli product range and available finishes. Valli will not be held responsible for any misprints and/or errors in the catalogue.

Il presente catalogo è soggetto a continui aggiornamenti. Ci riserviamo di apportare qualsiasi modifica ai prodotti qui presenti, di eliminarli dalla produzione, senza obbligo di preavviso. Immagini, dati, misure e disegni tecnici hanno esclusivamente carattere informativo e non possono essere ritenuti vincolanti. Consultare sempre il sito internet vallihandles.com per gli ultimi aggiornamenti disponibili sulla gamma prodotti Valli e sulle finiture disponibili. Valli declina ogni responsabilità per eventuali refusi e/o errori presenti sul catalogo.

