

dnd



22-
23

Un catalogo di maniglie
di alta qualità sviluppate
grazie a ricerca, creatività,
esperienza: valori che
da sempre accompagnano
Dnd e le sue collezioni.

A catalogue of high quality
handles developed thanks
to research, creativity and
experience: values
that have always
accompanied Dnd and its
collections.



dnd

**handles
with care**

**22-
23**

Maniglie che sono frutto di **cura, attenzione, passione.**



































Dnd mette la sua sapienza produttiva al servizio della migliore creatività, coinvolgendo nello sviluppo delle collezioni **progettisti di valore** per focalizzare l'attenzione verso il mondo del design, arricchire la gamma dei prodotti e soddisfare al meglio la progettazione degli interni contemporanei.







































*Handles that are the result of **care, attention and passion.***

*Dnd puts its manufacturing expertise at the service of the most brilliant creativity, collaborating with **outstanding designers** to develop collections that shine a light on the world of design, enrich its range of products and fully satisfy the needs of contemporary interior design.*

indice / *index*

design

aretè		214	eleonora <small>NEW</small>		078
aretè 02		218	eleonora 02 <small>NEW</small>		082
aretè L		220	esa		262
aretè L 02		224	esa due		258
art		282	fluke		238
blend		136	fluò		306
blip		288	fold		270
boole		160	fold 02		272
C-1918		200	freely <small>NEW</small>		086
change B 02		232	ginevra		198
chop		268	ginkgo		176
cloe		226	ginkgo biloba		180
cloe 02		230	go		308
dolce		286	havana		300
drop		130	holly		264
DUE		110	(IN)finito		092
edra 02		234	iki		170

intake		204	pod ^{NEW}		064
isabella		188	project		294
joy		274	project 02		296
joy 02		276	project zancata		298
levante		124	quattro 02 Z		314
linear		284	S40		315
link		314	S50		315
luce		248	S60		315
luce 02		252	safety		166
luce p ^{NEW}		242	san ^{NEW}		070
luce p 02 ^{NEW}		246	san 02 ^{NEW}		074
lucrezia		192	short		254
lucrezia 02		196	sike		292
luxury		208	sike 02		292
luxury 02		212	sochic		278
madeleine		154	sochic 02		278
minima		266	sochic L		280
mix		310	sochic L 02		280
nova		314	stick 02		312

design

timeless  184

tipo  314

twist  290

twist 02  290

















vita  302

vita 02  304

viva!  142

zeppelin  148

classic

airone		340
appia		338
ardea		328
beauty		340
beverly		332
bruxelles		340
cassia		330
classic		326
daniela		341
daniela p.		341
fedora		322
fiore		320
fiorenza		318
lady		336
latina		334
lirica		324
lorena		341

Combinazioni
particolari
Combinations 342

Maniglie per finestre
Windows handles 348

Maniglioni
Pull handles

aretè 370

aretè L 371

art 380

beverly 390

beverly corto 391

C-1918 372

C-1918 zancato 373

cloe 385

daniela 392

domus 384

eleonora  364

fluke 383

ginkgo 366

ginkgo biloba 367

go 381

(IN)finito  362

intake 382

latina 393

linear 376

logo	374
logo B	375
luce	389
lucrezia	368
luxury	369
only	388
pod 	360
project	378
project spostato	379
solid square	387
tube round	386
zeppelin 	361

Maniglioni per
alzante scorrevole
*Pull handles for
lift sliding system*

edra	396
edra corto	397
edra 02	398
edra 02 corto	399
liter	404
luce	400
luce 02	401
slide	402
slide corto	403
Placche incasso <i>Sliding door handles</i>	405

Pomoli
Knobs

easy	410
fiorenza	413
lucrezia	408
lucrezia 02	408
lucrezia 03	409
ovale centrale	413
project	411
quadro	412
ring	409
rondò	410
sfera	412
timeless	411
Pomolini per mobili <i>Furniture knobs</i>	414
Accessori per mobili <i>Furniture accessories</i>	415

Maniglie per porte scorrevoli
Sliding door handles

ginkgo tonda	418
ginkgo quadra	420
noxia	431
quadra	426
rettangolare	430
ring	422
rondò	424
tonda	428
Serrature <i>Locks</i>	432

Articoli vari

Other complements

Nottolini	
<i>Turn & releases</i>	436
Bocchette	
<i>Escutcheons</i>	452
Fermaporta	
<i>Door stop</i>	458
Chiavi	
<i>Keys</i>	459
Cerniere	
<i>Hinges</i>	460
Placche	
<i>Plates</i>	462

Sistemi per porte e finestre

<i>Door and window systems</i>	028
--------------------------------	-----

Legenda sistemi

<i>Systems summary</i>	040
------------------------	-----

Finiture

<i>Finishes</i>	044
-----------------	-----

Legenda finiture

<i>Finishes summary</i>	042
-------------------------	-----

azienda / company

Oggi Dnd è un punto di riferimento internazionale per la produzione di **maniglie che guardano alla qualità e al progetto.**

La storia di Dnd nasce oltre cinquant'anni fa, nel 1968, dall'**antica e spiccata dedizione artigianale e industriale** diffusa nella Val Sabbia, in provincia di Brescia: un territorio con un sapere materiale centenario, soprattutto a vocazione siderurgica. Nel tempo, l'azienda si è evoluta e si è concentrata sullo sviluppo e sull'incremento della produzione, rinnovando i processi produttivi e **specializzandosi nella lavorazione e nella rifinitura dei diversi metalli** destinati alla produzione delle maniglie, come la zama e l'alluminio, oltre naturalmente all'ottone.

*Today, Dnd is an international reference point for the production of **handles with a focus on high quality and good design.***

*The history of Dnd began more than fifty years ago, in 1968, arising from the **ancient and strong craft and industrial dedication** which has its strong roots in Val Sabbia, in the province of Brescia. This is an area with centuries of material knowledge, especially in the steel industry. The firm has evolved over time, concentrating on production growth, updating manufacturing processes and **specializing in the use and finishing of various metals** for the production of handles, including zamak and aluminium as well as brass.*



Dnd è diretta da Vilma Martinelli insieme ai figli Pietro e Simona: immaginano Dnd come **una fucina di idee in grado di coniugare la lunga esperienza produttiva** acquisita con la **creatività degli architetti e dei designer** di valore che vengono puntualmente coinvolti nel disegno dei prodotti.

Dal 2017, Dnd ha scelto **Giulio Iacchetti come direttore artistico**: un designer industriale di grande talento, impegnato nello sviluppo del catalogo, nella strategia, nella selezione dei progettisti e dei consulenti da coinvolgere.

*Dnd is managed by Vilma Martinelli together with her son Pietro and daughter Simona: they see the company as **a forge of ideas able to combine the long manufacturing experience** gathered over time with the **creativity of valuable architects and designers** who are duly involved in the design of the products.*

*Since 2017, Dnd appointed **Giulio Iacchetti as its art director**: a very talented industrial designer, involved in the development of the catalogue, the strategy, the selection of designers and consultants to be involved.*





**Azienda con
certificazione
sistema di qualità
UNI EN ISO 9001**

- Progettazione ottimizzata
- Costante formazione delle risorse umane
- Ambiente di lavoro controllato
- Produzione tecnologicamente avanzata
- Monitoraggio instancabile

***A company with
UNI EN ISO 9001
quality system
certification***

- *Optimized design*
- *Constant training of human resources*
- *Controlled working environment*
- *Technologically advanced production*
- *Continuous monitoring*



responsabilità / *responsibility*



Dnd è felice di promuovere ogni giorno azioni e processi attenti all'ambiente e si impegna in diversi progetti legati alla sostenibilità al fine di migliorare la salute del luogo di lavoro e sviluppare un senso di responsabilità, come strategia e come scelta.

Dnd is happy to promote environmentally friendly actions and processes every day, and is involved in a number of sustainability-related projects to improve health in the workplace and develop a sense of responsibility, as a strategy and as a choice.



WeForest

Compensiamo il consumo di carburante dei nostri automezzi e delle nostre autovetture con il rimboscamento nella regione del Katanino, in Zambia.

We offset the fuel consumption of our vehicles and cars with reforestation in the Katanino region of Zambia.



Stampa a freddo / Cold printing

Abbiamo sostituito il nostro sistema di stampa con i prodotti Epson Inkjet per la stampa a freddo, che riducono i costi e i consumi energetici fino all'83% rispetto alle stampanti laser.

We have replaced our printing system with Epson Inkjet cold printing products, which reduce costs and energy consumption by up to 83% compared to laser printers.



100% GREEN A2A

Certificazione della Camera di Commercio di Brescia che garantisce l'impiego di energia derivante da fonti 100% rinnovabili.

Certification from the Brescia Chamber of Commerce guaranteeing the use of energy from 100% renewable sources.



FSC®

Utilizziamo il minor quantitativo di carta possibile: abbiamo ridotto del 50% il consumo e scegliamo per i nostri listini e cataloghi solo carta certificata FSC®

We use as little paper as possible: we have reduced our paper consumption by 50% and choose only FSC®-certified paper for our price lists and catalogues.

made in italy



Produrre maniglie di qualità e **completamente Made in Italy da oltre cinquant'anni**: una scelta strategica di lunga data che si fonda sui valori della cultura aziendale italiana e sul profondo legame che Dnd ha nei confronti del suo territorio e del suo distretto, la Valle Sabbia.

Dnd è Made in Italy con l'orgoglio di realizzare prodotti grazie al **sapere**, alla **ricerca**, allo **stile** e alla **cura** che oggetti di piccole dimensioni – come le maniglie – richiedono.

L'eccellenza e il valore del design italiano si fondano da sempre sullo sviluppare, lavorare, rifinire e collaudare in Italia: passaggi importanti a tutela di prodotti di qualità.

Dalla creatività ai materiali, dal disegno al progetto, dalla produzione alle finiture, maniglie che sono da sempre fatte in Italia e fatte di Italia per entrare nelle case più belle e accoglienti, per caratterizzare **progetti architettonici di pregio** e per soddisfare al meglio le personalizzazioni del mondo contract, in Italia e nel mondo.

*To produce high-quality handles, **completely Made in Italy, for over fifty years**: a long-term strategy based on the values of an Italian corporate culture and the deep bond between Dnd and Valle Sabbia, its district and its territory.*

*Dnd is Made in Italy with pride, to create products thanks to **know-how, research, style, and all the care** that has to go into objects of small size such as handles. The excellence and value of Italian design are constants in the development, workmanship and testing, all done in Italy: important phases to guarantee products of the highest quality.*

*From creativity to materials, the drawing to the project, the production to the finishing, handles that are always made in Italy and made of Italy, to enter the most beautiful, appealing homes, to enhance **outstanding works of architecture**, to offer an optimal response to needs of customization in the contract sector, in Italy and the world.*



L'architettura per le mani *Handling architecture*

Coinvolgere degli architetti, che non si erano mai – o poco – occupati di design, per progettare una maniglia: questa la sfida immaginata da Dnd insieme a Giulio Iacchetti, proposta a **cinque studi** di origine italiana e molto attivi a livello internazionale che con entusiasmo hanno risposto all'appello. **Stefano Boeri Architettonici, Alfonso Femia, Maurizio Varratta, Cino Zucchi** e **967arch** hanno progettato cinque maniglie, presentate durante la Design Week milanese e poi entrate con successo in catalogo. *L'architettura per le mani* è il titolo del progetto: una riflessione intorno all'oggetto maniglia, che necessita sempre di essere fissato nello spazio con nuovi canoni estetici e nuovi equilibri formali.

Involving architects who had never – or seldom – focused on product design, inviting them to create a handle: this was the challenge formulated by Dnd together with Giulio Iacchetti and suggested to five architecture firms with an Italian background very active on an international level, who enthusiastically responded to the call. **Stefano Boeri Architettonici, Alfonso Femia, Maurizio Varratta, Cino Zucchi** and **967arch** designed five handles, which were presented during the Milan Design Week and then successfully entered in the catalogue. *Handling architecture* is the title of the project: a reflection around the handle object, which always needs to be fixed in space with new aesthetic canons and new formal balances.





Design focus

Per disegnare maniglie in cui siano evidenti la ricerca e la qualità del progetto, Dnd si impegna a collaborare con **progettisti di talento** su scala internazionale. Con continuità e attenzione, insieme al direttore artistico, vengono selezionati i designer a cui affidare i progetti destinati ad arricchire le collezioni Dnd: voci dal **miglior mondo del progetto**, vicine all'abitare contemporaneo.

*In order to design handles in which research and design quality are highlighted, Dnd is committed to working with **talented designers** on an international scale. With continuity and care, together with the artistic director, designers are selected to be entrusted with projects destined to enrich the Dnd collections: voices from **the best world of design**, close to contemporary living.*

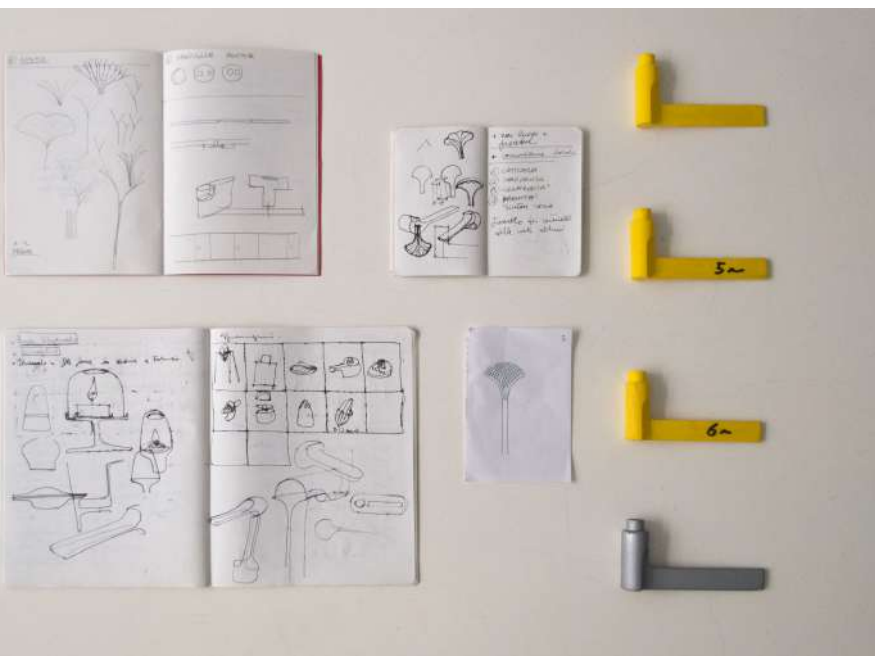

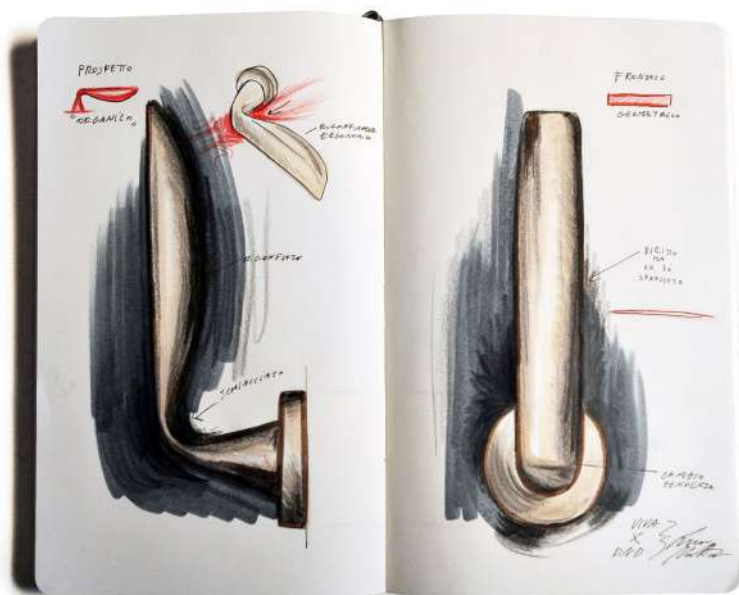

I prodotti sviluppati dai designer che collaborano con la fucina creativa Dnd sono sempre più numerosi: un **processo di crescita che è strategico e produttivo**.

I progettisti coinvolti sono sia giovani sia di lunga e riconosciuta esperienza: con linguaggi diversi, i designer si misurano con interesse e coinvolgimento con lo studio e lo sviluppo delle maniglie. La volontà di Dnd è di allargare il suo sguardo e accogliere idee e sfide sempre nuove.

*The products developed by the designers who collaborate with the Dnd creative forge are increasingly numerous: a **growth process that is both strategic and productive**.*

The designers involved are both young and with long and recognised experience: with different languages, the designers challenge themselves with interest and involvement in the study and development of the handles. Dnd wants to broaden its horizons and welcome new ideas and challenges.

Dnd ha scelto di lavorare con la **qualità, valore intrinseco del buon design.**

Una qualità diffusa e applicata a tutti i processi e le espressioni dell'azienda: dall'immagine coordinata al disegno delle maniglie, dalla produzione alla comunicazione e all'esposizione dei prodotti stessi.

Questa scelta è un fatto culturale e un percorso, in evoluzione e in crescita, che ha portato all'azienda **riconoscimenti importanti dal mondo del progetto:** un mondo di riferimento con cui Dnd si misura con impegno e positiva dinamicità.

*Dnd has chosen to work with **quality, an intrinsic value of good design.** A quality that is widespread and applied to all the processes and expressions of the company: from corporate identity to the design of the handles, from production to communication and the display of the products.*

*This choice is a cultural factor and a path, evolving and growing, which has brought the company **important recognition from the world of design:** a world of reference with which Dnd challenge itself with commitment and positive dynamism.*



**Good Design
Awards 2017**

Ginkgo
Design by Giulio Iacchetti



**Selected for
ADI DESIGN 2019**

(IN) finito
Design by Alfonso Femia



Dnd @ supersalone, Salone del Mobile.Milano, Rho Fiera - Milano (2021)

progettisti / *designers*



Stefano Boeri
Architetti



Achille
Castiglioni



Gianfranco
Cavaglia



Alfonso
Femia



Odo
Fioravanti



Jaime
Hayon



Holscher
Design



Studio
Hot Lab



Giulio
Iacchetti



Enrico
Martini



Andrea
Morgante



Luca
Nichetto



Nicola
Novelletto



Mario
Padiglione



Marco
Pisati



Karim
Rashid



**Mauro
Ronchi**



**Sandro
Santantonio**



**Mario
Scairato**



**Didier
Schweizer**



**Inga
Sempé**



**Alessandro
Stabile**



**Philippe
Tabet**



**Maurizio
Varratta**



**Cino
Zucchi**



967arch

– Door and

Sistemi
per porte
e finestre

window systems



minimal,
elegant,
Unico



Il sistema Unico / Unico, the system



Unico è il nuovo sistema per porte – ideato da Dnd – che riduce al minimo l'impatto visivo della rosetta sulla maniglia, valorizzandone così il design: una soluzione tecnica ed estetica ideale per gli ambienti contemporanei.

Grazie al suo piccolo volume, risulta poco visibile: misura solo 30 mm di diametro e 2 mm di spessore.

Il sistema, proposto in forma rotonda, è facile da installare e prevede la realizzazione di un foro da 22 mm sulla porta.

Unico is the new system for doors – designed by Dnd – that minimises the visual impact of the rose on the handle, thus enhancing its design: a technical and aesthetic solution that is ideal for contemporary interiors.

Thanks to its small volume, it is hardly visible: it measures only 30 mm in diameter and 2 mm in thickness.

The system, which comes in a round shape, is easy to install and requires a 22 mm hole to be drilled in the door.



032-

san
ZNE

U

Sistema disponibile
su 23 modelli in
tutte le loro finiture
*System available
on 23 models in all
their finishes*



boole
PCS

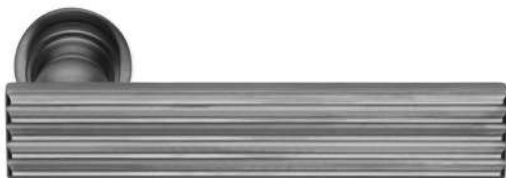

eleonora
PGS | forte®



ginkgo biloba
PVD-BG | forte®

**nottolino e bocchette /
turn & release and escutcheons**



2413 + A



BD80Y



BD80P



ginkgo
PCS

034-

Sistema Unico disponibile anche per finestre / *Unico System available also for windows*

Il nuovo sistema Unico è disponibile anche per serramenti, su cui la discrezione della rosetta – di soli 34 mm di diametro e 10 mm di spessore – esalta pienamente la forma e il disegno della maniglia.

Sistema DK a 8 scatti, facile da installare con la realizzazione di un foro da 13 mm sul serramento.

The new Unico system is also available for windows, where the discretion of the rose – just 34 mm in diameter and 10 mm in thickness – fully enhances the shape and design of the handle.

DK 8 position-system, easy to install by drilling a 13 mm hole in the frame.



luce P
ZCS



short
PGS | forte®



san
ZCS

Sistema Less is fine 4 mm / Less is fine system 4 mm

FINE

FINE

Porta / Door

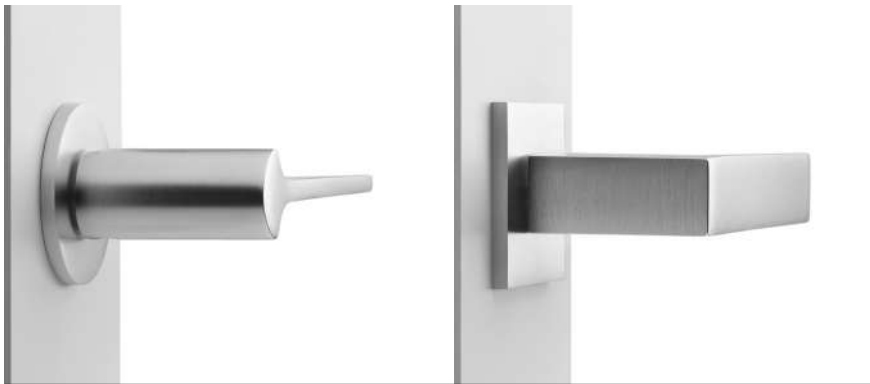

Il sistema Less is fine – di soli 4 mm – nasce grazie alle nuove tendenze dell'architettura. In soli 4 mm si trova la rosetta metallica con con molla uni-direzionale destra o sinistra – a compressione –, la quale permette un'installazione senza lavorazioni aggiuntive sulla porta. Brevetto Dnd.

The Less is fine system has a thickness of just 4 mm. It has been developed in tune with the latest design trends. A patented uni-directional left or right spring-loaded metal backplate facilitates installation. Dnd patent.

Sistema VIS 7 mm / VIS 7 mm system

VIS

VIS

Porta / Door



Componenti realizzati in nylon PA6 con molla uni-direzionale destra o sinistra. Rosette con diametro 50 mm e spessore 7 mm. Fori per fissaggio legno e interasse 38 mm per viti a connessione con o senza bussole.

Il sistema e la molla interna sono stati testati e certificati dal Laboratorio AQM - Cert.2012-1000/PPE, in base all normativa UNI EN 1906.

The parts are made with PA6 nylon, with uni-directional left or right spring. The backplate has a diameter of 50 mm and a thickness of 7 mm. Holes for attachment to wood, 38 mm centering, with or without connector nuts.

The inner spring and system are certified by AQM - Cert.2012-1000/Ppe in keeping with UNI EN 1906 standards.

Test di tenuta e usura dei componenti meccanici. Simulazione di apertura e chiusura oltre 200.000 cicli.

Categoria d'uso Grado 3: alta frequenza d'uso da parte del pubblico o scarsa cura; alte

probabilità d'uso improprio.

Durabilità Grado 7: frequenza d'uso elevata 200.000 cicli.

Azionamento Tipo B, serrature caricate a molla.

Mechanical components wear and tear test.

Opening and closing simulation to more than 200.000 cycles.

Category of use Grade 3: High frequenc of use by the public or others with little incentive to

exercise care and with a high chance of misuse.

Durability Grade 7: high frequency of use 200.000 cycles.

Type of operation B spring-loaded furniture.

Sistema 52 - 10 mm / 52 - 10 mm system

52

52

Porta / Door

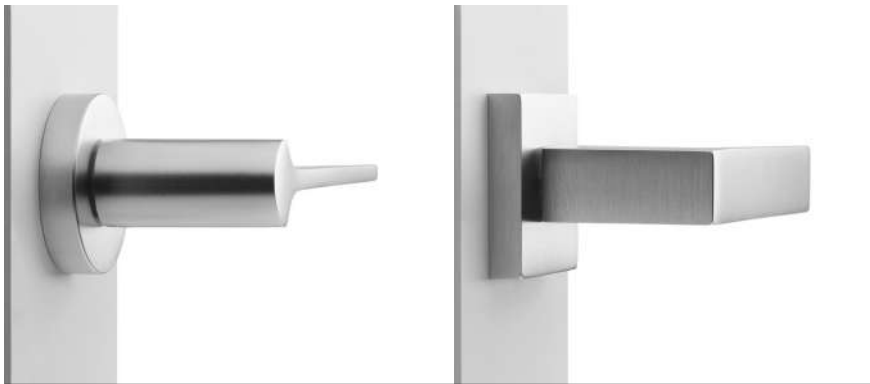

Componenti realizzati in metallo con molla bi-direzionale destra/sinistra.
Rosette con diametro 52 mm e spessore 10 mm. Fori per fissaggio legno e interasse 38 mm per viti a connessione con o senza bussole.

*The parts are in metal, with bi-directional left/right spring.
The backplates have a diameter of 52 mm and a thickness of 10 mm. Holes for attachment to wood, 38 mm centering, with or without connector nuts.*

Componenti tecnici / Technical components



Less is fine



VIS



VIS



52

DK VIS 9 mm



DK VIS TS 9 mm



Finestra / Window



Il DK VIS nasce dall'esigenza di ottenere un sistema esteticamente combinato con il sistema VIS per porta.

Le componenti tecniche restano così più discrete e lasciano pieno spazio al design della maniglia. Un meccanismo facile e veloce da montare, senza la necessità di lavorazioni sul serramento.

DK VIS is the result of the need for aesthetic coordination with the VIS system for doors. The technical components remain more discreet to offer greater freedom in the design of the handle. The mechanism is easy and quick to assemble.

Il DK anti intrusione con pulsante di sicurezza.

Sempre in 9 mm, sempre senza lavorazioni. Studiato appositamente per evitare che, forando il serramento dall'esterno, sia possibile azionare il meccanismo. TSDK non richiede lavorazioni e può essere installato anche in sostituzione a modelli precedenti. Inoltre è configurabile con tutti i modelli a catalogo.

The DK anti-intrusion model with security latch.

Still with a thickness of 9 mm, without the need for complicated installation operations. Specially designed to avoid the possibility of opening by drilling from the outside. TSDK does not require machining and can also be installed in place of previous models. It can also be coordinated with all the models in the catalogue.

legenda / summary

Porta / Door

- VIS** 50x7 mm
rosetta-bocchetta tonda
round rose-escutcheon
- FINE** 50x4 mm
rosetta-bocchetta tonda
round rose-escutcheon
- 52** 52x10 mm
rosetta-bocchetta tonda
round rose-escutcheon
- B** 50x10 mm
rosetta-bocchetta tonda bombata
rounded rose-escutcheon
- R** rosetta-bocchetta speciale
special rose-escutcheon
- V** rosetta-bocchetta ovale
oval rose-escutcheon
- S** 31x62x10 mm
rosetta-bocchetta stretta ovale
narrow oval rose-escutcheon
- U** 30x2 mm
rosetta minimal UNICO
minimal UNICO rose
- U** 25x2 mm
bocchetta minimal UNICO
minimal UNICO escutcheon
- VIS** 50x7 mm
rosetta-bocchetta quadra
square rose-escutcheon
- FINE** 50x4 mm
rosetta-bocchetta quadra
square rose-escutcheon
- 45** 45x10 mm
rosetta-bocchetta quadra
square rose-escutcheon
- 52** 52x10 mm
rosetta-bocchetta quadra
square rose-escutcheon
- R** rosetta-bocchetta speciale quadra
special square rose-escutcheon
- S** 31x62x10 mm
rosetta-bocchetta stretta rettangolare
narrow rectangular rose-escutcheon

Finestra / Window

- VIS** 31x64x9 mm
rosetta ovale per DK VIS
DK VIS oval rose
- U** 31x64x9 mm
rosetta ovale per DK VIS TS - sicurezza
DK VIS TS oval rose for security latch
- U** 34x10 mm
rosetta minimal UNICO per DK
DK minimal UNICO rose
- VIS** 31x64x9 mm
rosetta rettangolare per DK VIS
DK VIS rectangular rose
- U** 31x64x9 mm
rosetta rettangolare per DK VIS TS - sicurezza
DK VIS TS rectangular rose for security latch
- R** 31x64x12 mm
rosetta DND rettangolare pesante per DK
DND rectangular heavy rose for DK

NEW

NEW

NEW

finiture

– finishes

finiture / finishes

Finiture su ottone / Brass finishes

OLV	Lucido <i>Polished</i>
OS	Satinato <i>Satin</i>
SO	Sabbiato opaco <i>Matt sandblasted</i>
ORO	Placcato oro 24K <i>Gold plated 24K</i>
OROF	Oro francese antico <i>French antique gold</i>
OGC	Bronzo satinato lucido <i>Bright satin bronze</i>
OGH	Bronzo satinato opaco <i>Matt satin bronze</i>
AF	Anticato <i>Antique finish</i>
BSS	Bronzo scuro sfumato <i>Shaded dark bronze</i>
AB	Bronzato <i>Antique bronze</i>
OC	Power cromo lucido <i>Power polished chrome</i>
PCS	Power cromo satinato <i>Power satin chrome</i>
OCS	Cromo satinato <i>Satin chrome</i>
CCS	Cromo - Power cromo satinato <i>Chrome - Power satin chrome</i>
ONV	Nickel lucido <i>Polished nickel</i>
ONS	Nickel satinato <i>Satin nickel</i>

FAN	Ferro anticato <i>Antique iron</i>
OBN	Bianco <i>White</i>
BNL	Bianco lucido <i>Bright white</i>
ONO	Nero <i>Black</i>
V702	Marrone scuro <i>Dark brown</i>
OVE	Verde <i>Green</i>
TAN	Antracite <i>Anthracite</i>

forte®

Finiture PVD su ottone / PVD finishes on brass

PVD forte®	Ottone lucido <i>Polished brass</i>
PVD-BG forte®	Oro antico lucido <i>Antique bright gold</i>
PVD-SG forte®	Oro antico satinato <i>Antique satin gold</i>
PVD-SCB forte®	Rame satinato <i>Satin copper</i>
PGS forte®	Grafite satinato <i>Satin graphite</i>
PVX forte®	Inox satinato <i>Satin steel</i>

Finiture su zama / Zamak finishes		Finiture su alluminio / Aluminium finishes	
ZOS	Ottonato satinato <i>Satin brass color</i>	ACS	Cromo satinato <i>Satin chrome</i>
ZGH	Bronzo satinato opaco <i>Matt satin bronze</i>	ASV	Silver <i>Silver</i>
ZC	Cromo lucido <i>Polished chrome</i>	ARO	Oro satinato <i>Satin gold</i>
ZCS	Cromo satinato <i>Satin chrome</i>	ABR	Bronzo <i>Bronze</i>
ZNS	Nickel satinato <i>Satin nickel</i>	ABN	Bianco <i>White</i>
ZBN	Bianco <i>White</i>	ANE	Nero <i>Black</i>
ZNE	Nero <i>Black</i>	AAN	Antracite <i>Anthracite</i>
ZAN	Antracite <i>Anthracite</i>	ABT	Turchese <i>Turquoise</i>
		AVP	Violetto pastello <i>Pastel violet</i>
	Finiture su acciaio inox / Stainless steel finishes	AGO	Giallo oliva <i>Yellow olive</i>
S304	Acciaio AISI 304 satinato <i>AISI 304 satin steel</i>	ABC	Blu colomba <i>Blue dove</i>
S316	Acciaio AISI 316 satinato <i>AISI 316 satin steel</i>		
L316 + R	AISI 316 lucido + inserto rame PVD / <i>AISI 316 polished + PVD copper insert</i>		
S316 + R	AISI 316 satinato + inserto rame PVD / <i>AISI 316 satin + PVD copper insert</i>		
L316 + N	AISI 316 lucido + inserto rame nero / <i>AISI 316 polished + copper black insert</i>		
S316 + N	AISI 316 satinato + inserto rame nero / <i>AISI 316 satin + copper black insert</i>		

forte®

PVD, alta qualità nella tecnologia del rivestimento

forte® è il termine coniato da Dnd per identificare e dare enfasi alla speciale finitura per maniglie che si ottiene grazie alla tecnologia di rivestimento PVD.

Acronimo di **Physical Vapour Deposition**, PVD è una tecnologia di rivestimento per prodotti di alta qualità dalle eccellenti caratteristiche chimiche e tecniche, quali alta durezza, resistenza all'abrasione, ai graffi e alla corrosione.

Un rivestimento che è **perfettamente sostenibile**, a impatto ambientale ridotto e **ipoallergenico**.

PVD: high quality in coating technology

forte® is the term coined by Dnd to identify and emphasise the special finish for handles that is achieved thanks to PVD coating technology.

An acronym for **Physical Vapour Deposition**, PVD is a coating technology for high quality products with excellent chemical and technical characteristics, such as high hardness, resistance to abrasion, scratching and corrosion.

A coating that is **perfectly sustainable**, with low environmental impact and it is **hypoallergenic**.

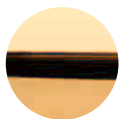

**PVD-BG
forte®**

oro antico
lucido /
polished
antique gold



**PVD-SG
forte®**

oro antico
satinato /
antique
satin gold



**PVD-SCB
forte®**

rame
satinato /
satin
copper



**PGS
forte®**

grafite
satinato /
satin
graphite



**PVX
forte®**

inox
satinato /
satin
steel

levante
Maurizio Varatta



PVD-BG | forte® Oro antico lucido / *Antique bright gold*

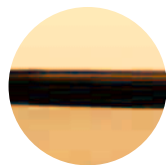

PVD-BG | forte®
Oro antico lucido.

Il colore dell'ottone proposto in una tonalità più calda: per un segno brillante e luminoso, dal fascino intramontabile.
Finitura garantita 20 anni.

PVD-BG | forte®
Antique bright gold.

The color of brass in a warmer tone: for a bright, luminous presence of timeless charm.
Finish guaranteed for 20 years.

madeleine
Inga Sempé

forte®



PVD-SG | forte® Oro antico satinato / *Antique satin gold*



PVD-SG | forte®
Oro antico satinato.

Solido, raffinato e senza tempo, un tono dell'ottone in grado di valorizzare al meglio sia ambienti dal sapore di un tempo, sia interni dal disegno minimale. Finitura garantita 20 anni.

PVD-SG | forte®
Antique satin gold.

Solid, refined and timeless, a tone of brass that is at its best in settings with the spirit of bygone days, but also in contexts of minimalist design. Finish guaranteed for 20 years.

ginkgo
Giulio lacchetti

forte[®]



PVD-SCB | forte®

Rame satinato /
Satin copper



PVD-SCB | forte®
Rame satinato.

Ottone con finitura rame, satinato. Dall'aspetto prezioso e dal grande fascino, il colore del rame sorprende e valorizza maniglie accolte in interni domestici dal carattere ricercato e dalla forte identità. Finitura garantita 10 anni.

PVD-SCB | forte®
Satin copper.

Brass with satin copper finish. With a precious image of great charm, the color of copper surprises and enhances handles in domestic interiors with an elegant character of forceful identity. Finish guaranteed for 10 years.

drop
Cino Zucchi

forte®



PGS | forte®

Grafite satinato / *Satin graphite*



PGS | forte®
Grafite satinato.

Ottone con finitura grafite, satinato.
Un tono tra il grigio scuro e il nero: un
colore originale per far emergere l'oggetto
maniglia in ambienti connotati da una
grande attenzione al progetto.
Finitura garantita 10 anni.

PGS | forte®
Satin graphite.

*Brass with satin graphite finish.
A tone between dark gray and black: an
original color to make the handle stand out
in contexts of great design refinement.
Finish guaranteed for 10 years.*

blend
967arch

forte®



PVX | forte® Inox satinato / *Satin steel*



**PVX | forte®
Inox satinato.**

Ottone con finitura Inox.
La tonalità contemporanea dell'acciaio
inossidabile satinato, perfettamente
adattabile ad ambienti domestici e pubblici.
Finitura garantita 20 anni.

**PVX | forte®
Satin steel.**

*Brass with stainless steel finish.
The contemporary tone of satin-finish
stainless steel adapts perfectly to both
domestic and public spaces.
Finish guaranteed for 20 years.*

boole
Odo Fioravanti

forte®



altre finiture

– more finishes

Finiture cromate / Chrome finishes

Finiture galvaniche da cromo e nickel
per superfici lucide e satinare.

*Chrome and nickel galvanic finishes for
polished and brushed surfaces.*



OC
Power cromo lucido
Power polished chrome



PCS
Power cromo satinato
Power satin chrome



ONV
Nickel lucido
Polished nickel



ONS
Nickel satinato
Satin nickel

Finiture dorate / Golden finishes

Il prestigio dell'ottone reso brillante o satinato tramite spazzolature e finiture artigianali realizzate da mani esperte. Placcature di oro 24K per rendere ancora più raffinate le superfici.

The prestige of brass, honed or satined by brushing and handmade finishing by skilled artisans. The 24K gold plating makes the surfaces even more refined.



ORO
Placcato oro 24K
Gold plated 24K



OROF
Oro francese antico
French antique gold



OLV
Lucido
Polished



OS
Satinato
Satin



SO
Sabbiato opaco
Matt sandblasted

Finiture bronzate / Bronze finishes

Bronzature e graffiature con verniciatura opaca. L'unicità di un materiale come l'ottone rende possibile una realizzazione molto raffinata.

Bronze coating and texturing with matt varnish. The unique character of brass in an exceptionally refined interpretation.



AB
Bronzato
Antique bronze



OGH
Bronzo satinato opaco
Matt satin bronze

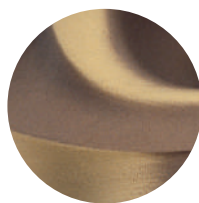

BSS
Bronzo scuro sfumato
Shaded dark bronze

Finiture anticate / Antique finishes

Finiture anticate, ottenute grazie a specifici processi di invecchiamento dell'ottone.

Antique finishes creating with special aging processes for brass.

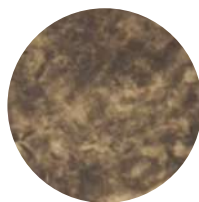

AF
Anticato
Antique finish

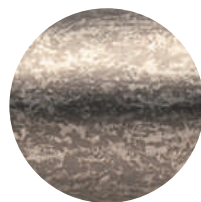

FAN
Ferro anticato
Antique iron

Finiture colorate RAL / RAL colors finishes

Toni inediti e originali per dare spazio alla creatività.

New, original tones to give room for creativity.



BNL
Bianco lucido
Bright white



OBN
Bianco
White

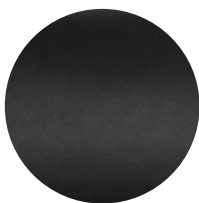

ONO
Nero
Black



V702
Marrone scuro
Dark brown



OVE
Verde
Green

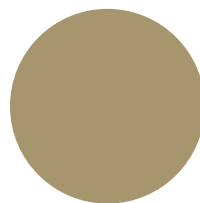

AGO
Giallo oliva
Yellow olive

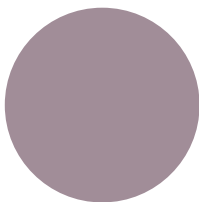

AVP
Violetto pastello
Pastel violet

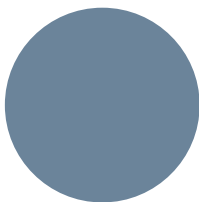

ABC
Blu colomba
Blue dove

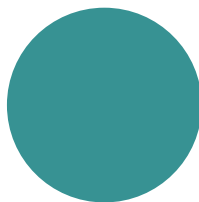

ABT
Turchese
Turquoise

resistenza al fuoco / *fire resistance*

Attestati di resistenza al fuoco EN 1634-2 ED. 2008

Test di resistenza al fuoco e al fumo per porte, finestre, serrature e componenti di ferramenta da costruzione.

I prodotti Dnd possono essere utilizzati per installazioni su porte e finestre che hanno ottenuto la certificazione EN 1634-2 e che hanno dimostrato di possedere la medesima resistenza al fuoco.

Attestation of fire resistance EN 1634-2 ED. 2008

Fire resistance and smoke control tests for door, shutter and openable window assemblies and elements of building hardware.

The Dnd products can be used for installation on doors and openable windows of similar type that had been tested according to EN 1634-2, and have been shown to have at last the same fire resistance.



– design

maniglie
design

handles

pod NEW



archiproducts
DESIGN AWARDS
2022

WINNER



Una serie realizzata con una lavorazione dedicata e originale: un tondino di materiale viene tornito alle estremità e opportunamente inclinato di 45 gradi, per generare un gesto dinamico ed equilibrato sull'orizzontalità della leva.

A series created with a dedicated and original manufacturing process: a rod of material is turned at each end and carefully bent at a 45 degrees angle, making for a dynamic and balanced gesture on the horizontal bar of the lever.

pod

design:
Holscher Design

made in italy



PD40
PCS

066-

dnd22-23

Ottone stampato a caldo
Hot stamped brass

new 2022



OLV
Lucido
Polished



OC
Power cromo lucido
Power polished chrome



PCS
Power cromo satinato
Power satin chrome



ONO
Nero
Black



PVD-BG | forte®
Oro antico lucido
Antique bright gold



PVD-SG | forte®
Oro antico satinato
Antique satin gold



PGS | forte®
Grafite satinato
Satin graphite



archiproducts
DESIGN AWARDS
2022

WINNER

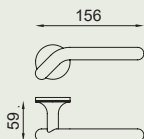

FINE PD40



PD27

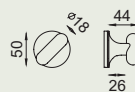

RDN77+A

Holscher Design



Studio di progettazione multidisciplinare con base a Copenhagen, in Danimarca, è attivo dal 1990 e si colloca tra le più riconosciute e premiate agenzie di progettazione della Scandinavia. Holscher Design è diretto da un team di cinque soci, è fortemente radicato nella tradizione dei Paesi del Nord e sviluppa progetti a livello internazionale in diversi ambiti, tra cui illuminazione, sanitari, componenti per l'edilizia, design urbano. Tra le collaborazioni, Geberit, Flos, JCDecaux, Philips, Lamy.

A multidisciplinary design firm based in Copenhagen, Denmark, Holscher Design has been active since 1990 and is amongst the most well-established and award-winning design agencies in Scandinavia. The studio is headed up by a team of five partners, with deep roots in the tradition of the Nordic countries, and develops international projects spanning various fields, including lighting, sanitaryware, construction components and urban design. Its many collaborations include Geberit, Flos, JCDecaux, Philips and Lamy.

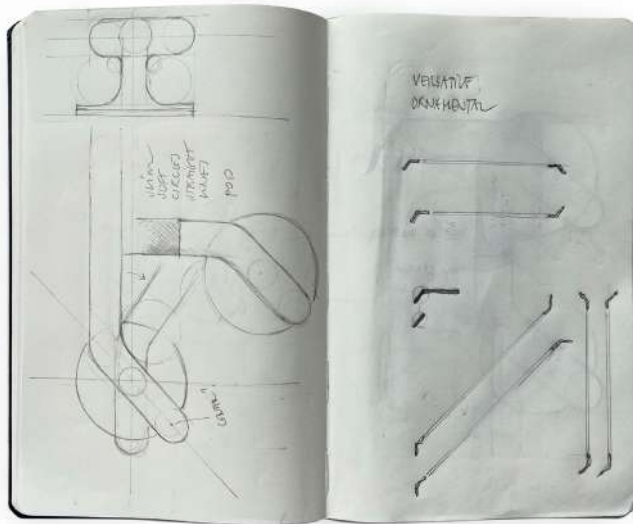

Pod
Disegni della maniglia di /
Handle sketches by
Holscher Design



Pantone Universe Table Setting, Room Copenhagen (2010)



Pure, Flos (2007)



Camera, Flos (2020)

san 





Come a ricordare l'elegante e slanciato profilo di una katana. Curve morbide e in tangenza caratterizzano questa originale maniglia dall'estetica e dal nome, di ispirazione giapponese.

Delicately reminiscent of the elegant, slender profile of a katana. Soft, tangential curves characterise this original handle with a Japanese-inspired name and aesthetic.

san

design:
Philippe Tabet

made in italy



SN12
ZOS

072-

dnd22-23

Zama
Zamak

new 2022



ZC
Cromo lucido
Polished chrome



ZCS
Cromo satinato
Satin chrome



ZNE
Nero
Black



ZAN
Antracite
Anthracite

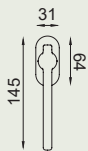
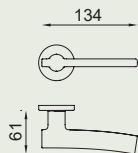

VIS SN12

U SN80

VIS SN22V

U SN22TS

U SN22U

san 02

design:
Philippe Tabet

made in italy



SN14
ZNE

074-

dnd22-23

Zama
Zamak

new 2022



ZC
Cromo lucido
Polished chrome



ZCS
Cromo satinato
Satin chrome



ZNE
Nero
Black



ZAN
Antracite
Anthracite

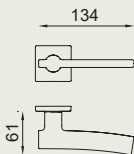

VIS SN14

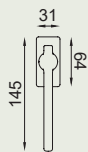

VIS SN25V

 SN25TS

Philippe Tabet



Nato e cresciuto in Francia, a Versailles, ha studiato design industriale a Lione e Parigi. Vive a Milano, dove dal 2014 ha sede il suo studio di progettazione e dove insegna presso Domus Academy e Naba. Collabora con aziende rinomate quali Pianca, Lexon, Infiniti Design e Plust e al contempo sviluppa un suo percorso artigianale, con processi e risultati che esplorano materiali e tecniche di lavorazione – come per la serie di maschere Order. Ha vinto il premio Infiniti Design nel 2014 e Young&Design nel 2017; ha ottenuto il Good Design Award nel 2018.

Born and raised in Versailles, France, he studied industrial design in Lyon and Paris. He now lives in Milan, where he established his design firm in 2014 and where he teaches at Domus Academy and Naba. He collaborates with renowned companies such as Pianca, Lexon, Infiniti Design and Plust, whilst at the same time following his own path as a craftsman, with processes and results that are explorations of materials and techniques, as can be seen from Order, his series of masks. He won the Infiniti Design award in 2014 and the Young&Design award in 2017, before garnering the Good Design Award in 2018.

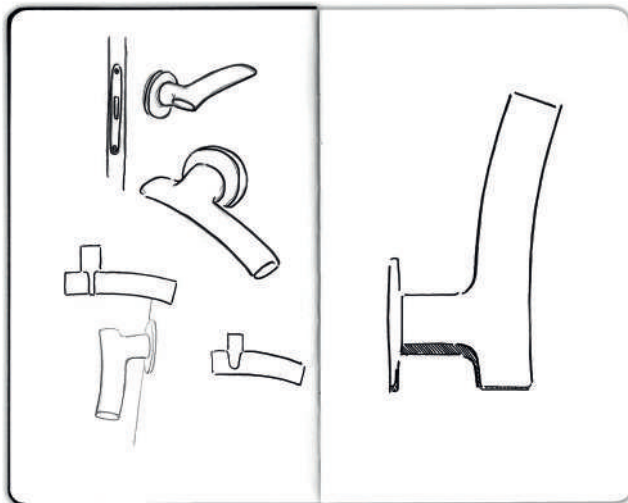

San
Disegni della maniglia di /
Handle sketches by
Philippe Tabet



Order, autoproduzione / self production (2017)



Slide, Lexon (2017)



Fushimi Lounge, Pianca (2020)

eleonora 





Sottili scanalature per l'impugnatura, in omaggio allo stile ionico; e un modellato morbido ma rigoroso per lo stelo: una maniglia che guarda agli stili della storia, in equilibrio tra antica Grecia e Rinascimento.

Subtle grooves in the handle, redolent of the Ionic style, along with a soft yet rigorous shape for the stem: a handle that draws upon styles from throughout history, carefully balanced between Ancient Greece and the Renaissance.

eleonora

design:
Marco Pisati

made in italy

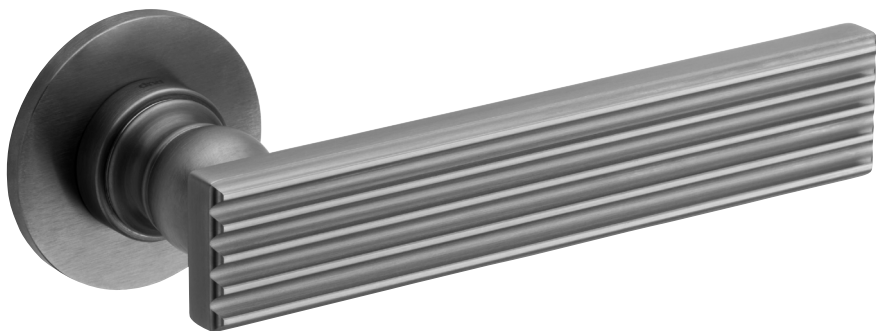

EL40
PGS|forte®

080-

dnd22-23

Ottone forgiato
Forged brass

new 2022



OGH
Bronzo satinato opaco
Matt satin bronze



ONV
Nickel lucido
Polished nickel



PVD-BG | forte®
Oro antico lucido
Antique bright gold



PVD-SG | forte®
Oro antico satinato
Antique satin gold

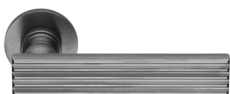

PGS | forte®
Grafite satinato
Satin graphite

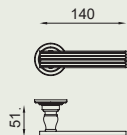

FINE EL40

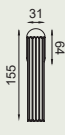

VIS EL22V

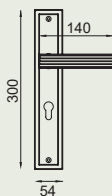

EL10



EL27 singolo

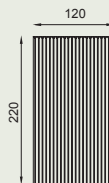

EL29 singolo

R EL13

U EL22U

EL28 set

EL30 set

U EL80

eleonora 02

design:
Marco Pisati

made in italy



EL41
OGH

082-

dnd22-23

Ottone forgiato
Forged brass

new 2022



OGH
Bronzo satinato opaco
Matt satin bronze



ONV
Nickel lucido
Polished nickel

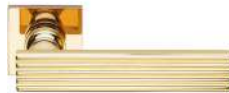

PVD-BG | forte®
Oro antico lucido
Antique bright gold



PVD-SG | forte®
Oro antico satinato
Antique satin gold

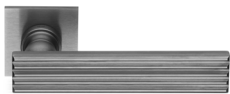

PGS | forte®
Grafite satinato
Satin graphite

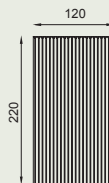
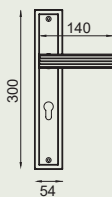
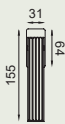
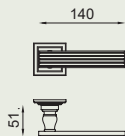

FINE EL41

R EL25

EL10

EL27 singolo

EL29 singolo

R EL19

EL28 set

EL30 set

Marco Pisati



Designer fiorentino, architetto di formazione, è affascinato dai nuovi materiali e dalle nuove tecnologie. Sperimenta le sue idee nei settori più diversi, progettando per diverse aziende: ASI (Agenzia Spaziale Italiana), Emilio Pucci, Antonio Lupi, Cordivari, Cristina Rubinetterie, Gattoni Rubinetterie, Treemme Rubinetterie, Glass Design, K8 Radiatori. Diversi i premi e i riconoscimenti ottenuti dai suoi prodotti: Red Dot Design Award, German Design Award, Archiproducts Design Award, ADI Ceramics & Bathroom Design Award.

A designer from Florence, trained as an architect, fascinated by new materials and technologies. He experiments with ideas in a wide range of sectors, designing for different companies: ASI (Italian Space Agency), Emilio Pucci, Antonio Lupi, Cordivari, Cristina Rubinetterie, Gattoni Rubinetterie, Treemme Rubinetterie, Glass Design, K8 Radiatori. He has been awarded many design awards for his projects: Red Dot Design Award, German Design Award, Archiproducts Design Award, ADI Ceramics & Bathroom Design Award.

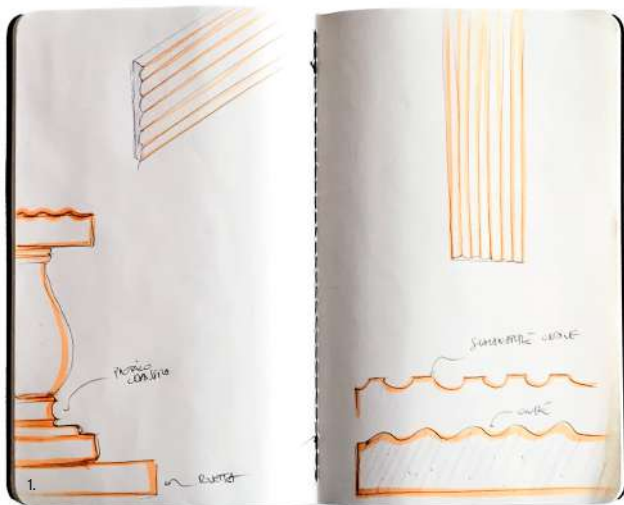

Eleonora
Disegni della maniglia di /
Handle sketches by
Marco Pisati



Tessuto, Cordivari (2020)



Kea, Treemme (2019)



Q30, Treemme (2019)

freely 





Un design sobrio ed essenziale, che combina impatto estetico e tratti funzionali attraverso una silhouette perfettamente ergonomica e mai invasiva, costituita da un unico elemento sinuoso che trova nella cavità centrale la sua peculiarità differenziante.

A sober and essential design, which combines beauty and functional features through a perfectly ergonomic and never-invasive profile, made up of a single sinuous element presenting a differentiating peculiarity in the central cavity.

freely

design:
Giulio lacchetti

made in italy



FR01
ACS

088-

dnd22-23

Alluminio
Aluminium

new 2022



ACS
Cromo satinato
Satin chrome



AAN
Antracite
Anthracite



ANE
Nero
Black

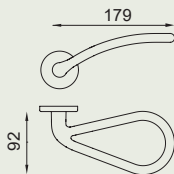

FR01

Giulio Iacchetti



Con base a Milano, si occupa di industrial design dal 1992. Tra le diverse aziende con cui collabora: Alessi, Artemide, Foscarini, IFI, Magis, Meritalia, Moleskine, Nava, Montini, United Pets. È direttore artistico di diversi brand, tra cui Abet Laminati, Internoitaliano, Pandora design e Dnd. Nel maggio 2009 la Triennale di Milano ha ospitato una sua mostra personale intitolata "Giulio Iacchetti. Oggetti disobbedienti". È stato premiato con due premi ADI Compasso d'Oro (2001 e 2014) e ha ricevuto diversi riconoscimenti internazionali.

Based in Milan, he is an industrial designer since 1992. Among the companies he works with, Alessi, Artemide, Foscarini, IFI, Magis, Meritalia, Moleskine, Nava, Montini, United Pets. He is artistic director for several brands, including Abet Laminati, Internoitaliano, Pandora design and Dnd. In May 2009 the Triennale di Milano held a solo exhibition titled "Giulio Iacchetti. Disobedient objects". He was awarded two ADI Compasso d'Oro (2001 and 2014) and he has been awarded many international design awards.

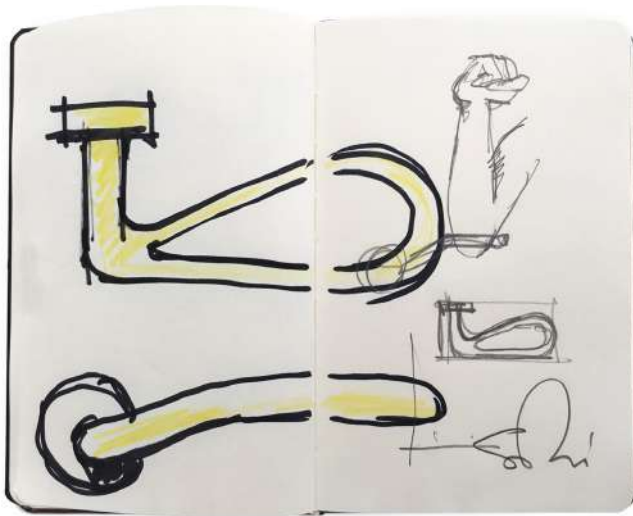

Freely
Disegni della maniglia di /
Handle sketches by
Giulio Iacchetti



Ora In/Ora Out, Alessi (2015)



Moscardino, Pandora Design (2000)



Affi, Internoitaliano (2012)



Classic Collection, Moleskine (2017)

(IN)finito



**Selezionato
ADI DESIGN 2019**
*Selected for
ADI DESIGN 2019*



Come un filo bidimensionale che arriva dai bordi della porta, disegna la maniglia e poi continua il suo viaggio, ora verso l'altro lato, ora verso l'alto, ora nell'altra direzione.

Like a two-dimensional line that arrives from the edges of the door and draws the handle before continuing on its way, towards the other side, upward, in the opposite direction.

(IN)finito

design:
Alfonso Femia

made in italy



IF10
ONO

094-

dnd22-23

Ottone stampato a caldo
Hot stamped brass



OLV new
Lucido
Polished



AB new
Bronzato
Antique bronze



SO new
Sabbiato opaco
Matt sandblasted



PCS
Power cromo satinato
Power satin chrome



ONO
Nero
Black



Selezionato ADI DESIGN 2019
Selected for ADI DESIGN 2019

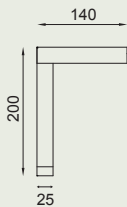

IF10

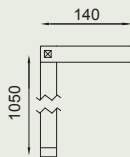

IF10/L
Placca lunga 1050 mm
Long plate 1050 mm

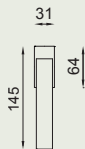

 IF25TS

 IF25

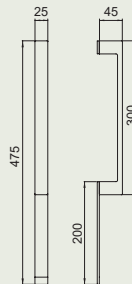

IF29 - singolo

IF30 - set

(IN)finito 





Il modello di maniglia
si declina in diverse
soluzioni.

*The door handle
model comes in
different versions.*

La rosetta diventa
un elemento minimo
e si innesta alla base
della maniglia.

*The rose becomes a
minimal element and
gets in position at the
handle base.*

(IN)finito

design:
Alfonso Femia

made in italy



IF01
PCS

098-

dnd22-23

Ottone stampato a caldo
Hot stamped brass



OLV new
Lucido
Polished



AB new
Bronzato
Antique bronze



SO new
Sabbiato opaco
Matt sandblasted



PCS
Power cromo satinato
Power satin chrome



ONO
Nero
Black

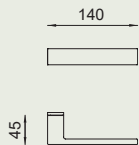

IF01

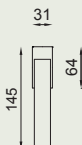

R IF25

🔒 IF25TS

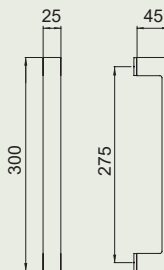

IF27 - SINGOLO

IF28 - SET

(IN)finito NEW





La placca riprende
il profilo della maniglia,
si fa sottile e si adatta
orizzontalmente alla
superficie della porta.

*The plate is shaped
like the door handle,
it becomes thin and
conforms horizontally
to the door surface.*

(IN)finito

design:
Alfonso Femia

made in italy



IF11
OLV

102-

dnd22-23

Ottone stampato a caldo
Hot stamped brass



OLV new
Lucido
Polished



AB new
Bronzato
Antique bronze



SO new
Sabbiato opaco
Matt sandblasted



PCS
Power cromo satinato
Power satin chrome



ONO
Nero
Black

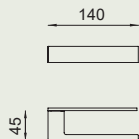

IF11

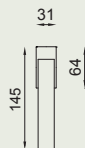

R IF25

🔒 IF25TS

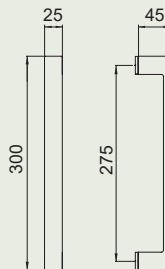

IF27 - SINGOLO

IF28 - SET

(IN)finito

design:
Alfonso Femia

made in italy



IF40
PCS

104-

dnd22-23

Ottone stampato a caldo
Hot stamped brass

new 2022



OLV new
Lucido
Polished



AB new
Bronzato
Antique bronze



SO new
Sabbiato opaco
Matt sandblasted



PCS
Power cromo satinato
Power satin chrome



ONO
Nero
Black

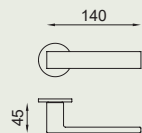

FINE IF40

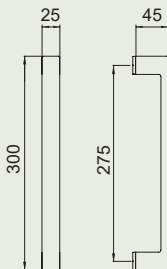

IF27 - SINGOLO

IF28 - SET

(IN)finito

design:
Alfonso Femia

made in italy



IF41
ONO

106-

dnd/22-23

Ottone stampato a caldo
Hot stamped brass

new 2022



OLV new
Lucido
Polished



AB new
Bronzato
Antique bronze



SO new
Sabbiato opaco
Matt sandblasted



PCS
Power cromo satinato
Power satin chrome



ONO
Nero
Black

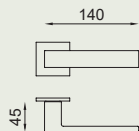

FINE IF41

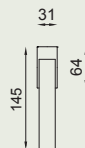

R IF25

🔒 IF25TS

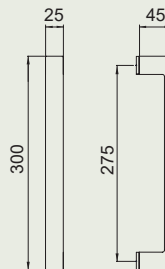

IF27 - SINGOLO

IF28 - SET

Alfonso Femia



Originario di Taurianova (RC), vive tra Genova, Milano e Parigi. Laureato presso la Facoltà di Architettura dell'Università di Genova nel 1992, è iscritto all'Ordine degli Architetti di Genova, dell'Île-de-France e della Svizzera.

Ha insegnato Progettazione Architettonica alla Kent State University di Firenze, alla Facoltà di Architettura di Ferrara e a quella di Genova. Fondatore di 5+1 nel 1995, crea 5+1AA nel 2005 e 5+1AA Parigi nel 2007. Tra i suoi progetti, la nuova sede BNP Paribas a Roma, i Docks di Marsiglia, le OGR di Torino.

Born in Taurianova (RC), he lives between Genoa, Milan and Paris. With a degree from the School of Architecture of the University of Genoa in 1992, he is a member of the Architects Associations of Genoa, Île-de-France and Switzerland.

He has taught Architectural Design at Kent State University in Florence, and the Schools of Architecture of Ferrara and Genoa. He was a founder of 5+1 in 1995, and created 5+1AA in 2005 and 5+1AA Paris in 2007. His projects include the new BNP Paribas headquarters in Rome, the Docks of Marseille, the OGR in Turin.

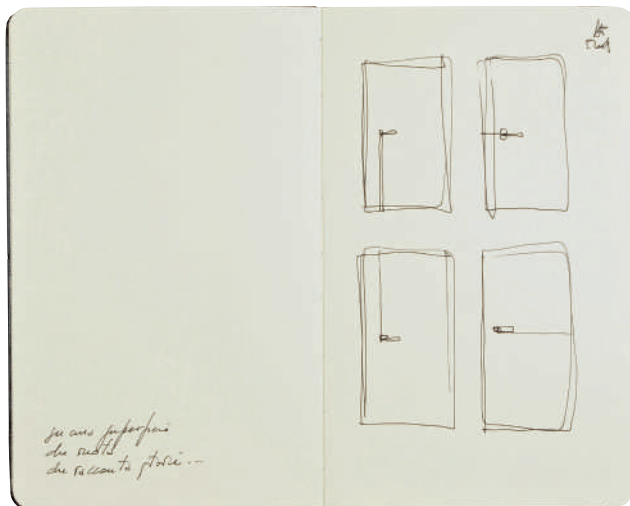

(IN) finito
Disegni della maniglia di /
Handle sketches by
Alfonso Femia



Nuova Biblioteca, La Spezia/Italy (2012-2016)



BNL-BNP Paribas Headquarters, Roma/Italy (2012-2017)



I Giardini di Gabriel, Asnières-sur-Seine/France (2013-2016)



Marseilles Docks, Marseille/France (2009-2015)

DUE





Una soluzione
dalla forza plastica
essenziale:
la sua figura è resa
primigenia attraverso
la trasformazione
dei due tradizionali
elementi funzionali,
l'impugnatura e
la rosetta, in una
coppia di sottili
parallelepipedi
perfettamente
uguali tra loro.

*A solution of essential
sculptural force:
the figure becomes
primeval through
the transformation
of the two traditional
functional elements,
the grip and the
plate, into a pair
of slender
parallelepipeds,
perfectly equal.*

DUE

design:
**Stefano Boeri
Architetti**

made in italy



DU10
PCS

112-

dnd22-23

Ottone stampato a caldo
Hot stamped brass



PCS
Power cromo satinato
Power satin chrome



ONO
Nero
Black



PGS | forte®
Grafite satinato
Satin graphite



PVD-SG | forte®
Oro antico satinato
Antique satin gold

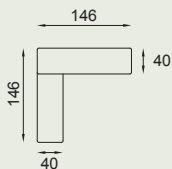

VIS DU10

R DU25

🔒 DU25TS

DUE **NEW**





La sovrapposizione di due sottili parallelepipedi tra loro uguali genera un elegante elemento geometrico sulla porta.

The overlapping of two equal, slender parallelepipeds produces a refined and geometric element on the door.

DUE

design:
**Stefano Boeri
Architetti**

made in italy



DU11
PVD-SG | forte®

116-

dnd22-23

Ottone stampato a caldo
Hot stamped brass

new 2022



PCS
Power cromo satinato
Power satin chrome



ONO
Nero
Black



PGS | forte®
Grafite satinato
Satin graphite



PVD-SG | forte®
Oro antico satinato
Antique satin gold

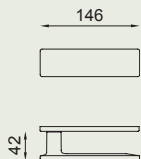

DU11



R DU25

🔒 DU25TS

DUE

design:
Stefano Boeri
Architetti

made in italy

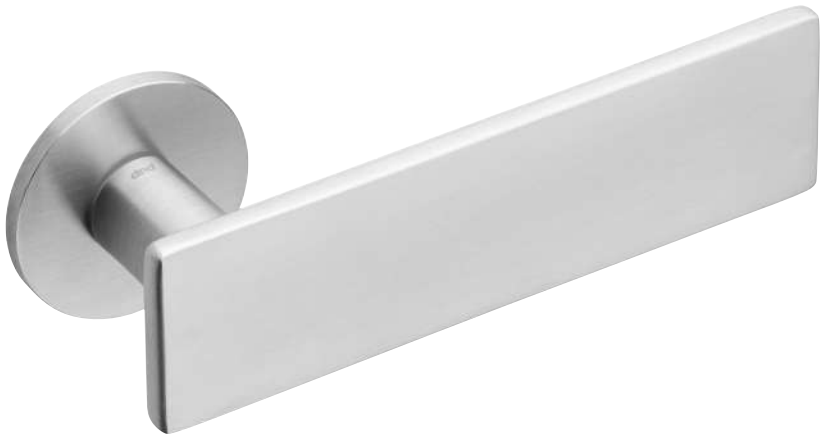

DU40
PCS

118-

dnd22-23

Ottone stampato a caldo
Hot stamped brass

new 2022



PCS
Power cromo satinato
Power satin chrome



ONO
Nero
Black



PGS | forte®
Grafite satinato
Satin graphite



PVD-SG | forte®
Oro antico satinato
Antique satin gold

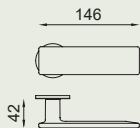

FINE DU40

U DU80

VIS DU25V

U DU22U

DUE

design:
**Stefano Boeri
Architetti**

made in italy

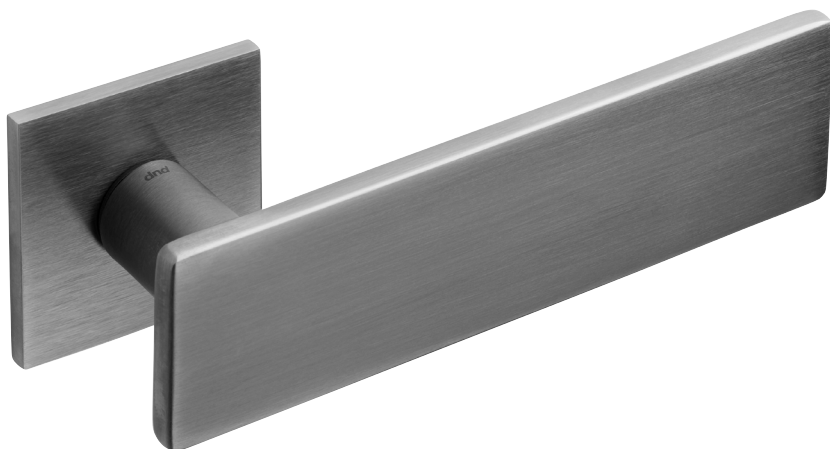

DU41
PGS|forte®

120-

dnd22-23

Ottone stampato a caldo
Hot stamped brass

new 2022



PCS
Power cromo satinato
Power satin chrome



ONO
Nero
Black



PGS | forte®
Grafite satinato
Satin graphite



PVD-SG | forte®
Oro antico satinato
Antique satin gold

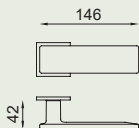

FINE DU41

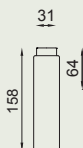

R DU25

🔒 DU25TS

Stefano Boeri Architetti



Con sede a Milano e uffici a Shanghai (dal 2014) e Tirana (dal 2015), Stefano Boeri Architetti si dedica dal 1993 alla progettazione e alla ricerca, principalmente in ambito architettonico e urbanistico, ma anche culturale, del design e dell'interior design.

Lo studio ha sviluppato progetti architettonici e di rigenerazione in luoghi complessi e in più continenti. Tra i progetti costruiti più noti, il Bosco Verticale di Milano, la Villa Méditerranée a Marsiglia e la Casa del Mare sull'isola de La Maddalena, in Sardegna.

Based in Milan, with offices in Shanghai (since 2014) and Tirana (since 2015), Stefano Boeri Architetti has focused since 1993 on design and research, mostly in the fields of architecture and urban planning, but also on culture and interior design.

The studio has developed projects of architecture and urban regeneration in complex locations and on multiple continents. Outstanding constructed works include the Bosco Verticale in Milan, the Villa Méditerranée in Marseille and the Casa del Mare on the island of La Maddalena, Sardinia.



DUE

Disegni della maniglia di /
Handle sketches by
Stefano Boeri Architetti



Villa Méditerranée, Marseille/France (2004-2013)



Il polo del gusto, Amatrice/Italy (2016-2017)



Bosco Verticale, Milano/Italy (2009-2014)

levante





L'essenzialità di una forma asciutta e semplice, caratterizza un oggetto il cui disegno si identifica con la sua funzione.

The essence of a terse, simple form, an object whose design would be identified with its function.

levante

design:
Maurizio Varratta

made in italy



LE40
PGS|forte®

126-

dnd22-23

Ottone stampato a caldo
Hot stamped brass



PCS
Power cromo satinato
Power satin chrome



PGS | forte®
Grafite satinato
Satin graphite



PVD-SCB | forte®
Rame satinato
Satin copper



PVD-SG | forte®
Oro antico satinato
Antique satin gold



PVX | forte®
Inox satinato
Satin steel

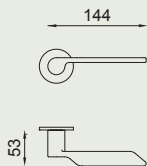

FINE LE40

U LE80

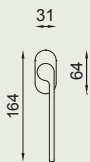

VIS LE22V

U LE22TS

U LE22U



Prysmian Group Headquarters, Milano/Italy (2014-2017)



Auditorium Fiera di Milano, Milano/Italy (2005-2009)



iGuzzini Light Laboratory, Recanati/Italy (2006-2009)

drop





Una maniglia dalle
linee morbide e
affabili, in cui l'ottone
si lascia apprezzare
nella sua forma
migliore.

*A door handle
featuring a soft and
affable shape, in which
brass conveys its
allure thanks to the
best possible form.*

drop

design:
Cino Zucchi

made in italy



DP40
PVD-SCB | forte®

132-

dnd22-23

Ottone stampato a caldo
Hot stamped brass

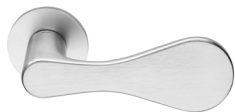

PCS
Power cromo satinato
Power satin chrome



PGS | forte®
Grafite satinato
Satin graphite



PVD-SG | forte®
Oro antico satinato
Antique satin gold



PVD-SCB | forte®
Rame satinato
Satin copper



PVX | forte®
Inox satinato
Satin steel

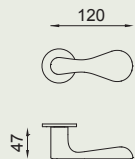

FINE DP40

U DP80

VIS DP22V

U DP22TS

U DP22U

Cino Zucchi



Nato a Milano, Cino Zucchi si è laureato in architettura al M.I.T. di Boston e al Politecnico di Milano. Autore di articoli e libri di teoria architettonica e urbana, ha partecipato a varie edizioni della Triennale di Milano e della Biennale di Architettura di Venezia. Insieme allo studio CZA ha progettato e realizzato molti progetti: tra i più noti, quelli della ex Junghans a Venezia, dell'ex Alfa Romeo - Portello Nord e della Corte Verde a Milano; il master plan per Keski Pasila a Helsinki, la nuova sede Lavazza (TO), gli HQ Salewa (BZ).

Born in Milan, Cino Zucchi has earned degrees in Architectural Design at M.I.T. and at Politecnico di Milano. Author of several articles and books on architectural and urban theory, he has taken part in various editions of the Milan Triennale and of the Venice Biennale of Architecture. With his studio CZA, he has designed and completed a number of projects, including the former Junghans factory site in Venice; the former Alfa Romeo-Portello Nord area and the Corte Verde in Milan; the Keski-Pasila master plan in Helsinki; the Lavazza HQ (TO); and the Salewa HQ (BZ).

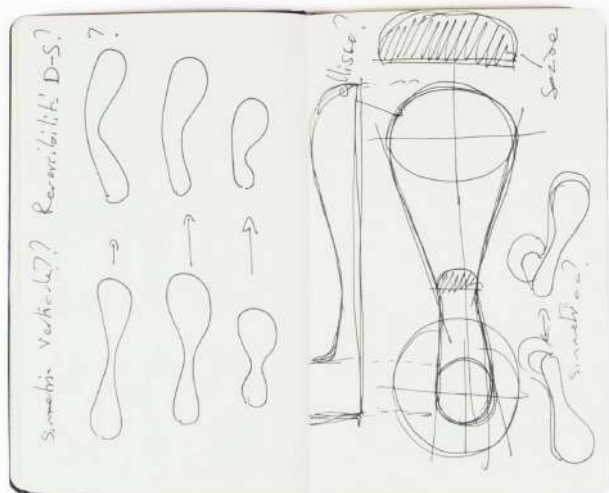

Drop
Disegni della maniglia di /
Handle sketches by
Cino Zucchi



La Corte Verde, Milano/Italy (2006-2013)



D Residential Building, Venezia/Italy (1997-2003)



Salewa Headquarters, Bolzano/Italy (2007-2011)



Lavazza Headquarters, Torino/Italy (2010-2017)

blend





Una maniglia nata dalla volontà di combinare forme elementari, cilindro e rettangolo, nella ricerca di un equilibrio complessivo ma soprattutto di una immediata e percettiva iconicità.

A handle based on the urge to combine basic forms, a cylinder and a rectangle, in pursuit of an overall balance and above all an immediate perceptive impact.

blend

design:
967arch

made in italy



BN10/R
PCS

138-

dnd22-23

Ottone
Solid brass



PCS
Power cromo satinato
Power satin chrome



BNL
Bianco lucido
Bright white



PGS | forte®
Grafito satinato
Satin graphite



PVD-SG | forte®
Oro antico satinato
Antique satin gold



PVX | forte®
Inox satinato
Satin steel

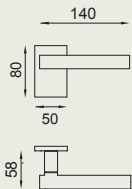

BN10/R

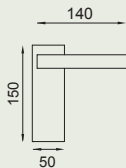

BN10

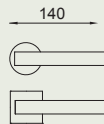

FINE BN40

FINE BN41

U BN80

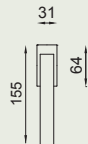

R BN25

🔒 BN25TS

U BN22U

967arch



Fondato a Milano nel 1999 da Cesare Chichi e Stefano Maestri, lo studio 967arch affianca all'attività di progettazione architettonica e di interior quella di design del prodotto in un continuo passaggio di influenze, sperimentazioni e contaminazioni. Il team ha affrontato progetti su scale differenti, con un focus particolare per le sedi e gli uffici di aziende tra cui Google, Petronas, WPP, Cisco e Ferrero. I progetti di design vedono collaborazioni con aziende come Poltrona Frau, Davide Groppi, Dieffebi, GE Giussani, MDF Italia, Zumtobel e Las Mobili.

Founded in Milan in 1999 by Cesare Chichi and Stefano Maestri, the firm 967arch combines activities of architectural and interior design with work on products, in a continuous exchange of influences, experimentation and contamination. The team has tackled projects on many different scales, with a particular focus on headquarters and offices for companies like Google, Petronas, WPP, Cisco and Ferrero. The projects of product design include collaborations with companies like Poltrona Frau, Davide Groppi, Dieffebi, GE Giussani, MDF Italia, Zumtobel and Las Mobili.

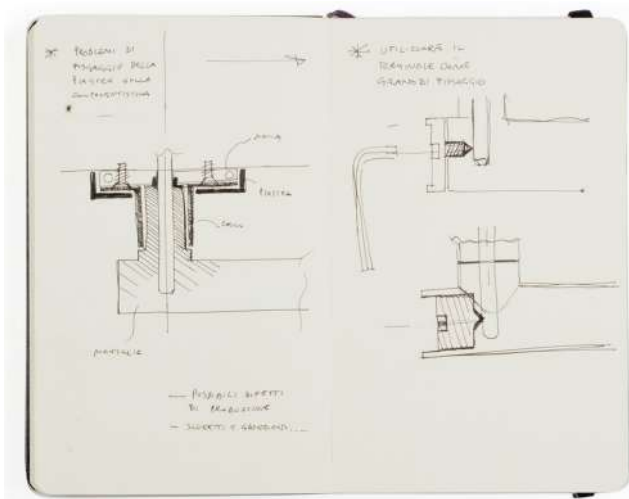

Blend
Disegni della maniglia di /
Handle sketches by
967arch



Amplifon Headquarters, Milano/Italy (2016)



Inter San Siro locker room, Milano/Italy (2017)



Cisco (Torri Bianche), Vimercate/Italy (2016)

viva!





Una maniglia che nasce dalla fusione dei fondamentali aspetti ergonomici con la sobrietà dell'impatto visivo. Viva! presenta un aspetto diverso a seconda del punto di osservazione, con tratti lineari o morbidi e sinuosi a caratterizzarla.

A handle based on the fusion of fundamental ergonomic aspects with understated visual impact. Viva! looks different from various vantage points, with linear or soft, sinuous features.

viva!

design:
Luca Nichetto

made in italy



VV40
PGS|**forte**®

144-

dnd22-23

Ottone stampato a caldo
Hot stamped brass



OGH
Bronzo satinato opaco
Matt satin bronze



PCS
Power cromo satinato
Power satin chrome



ONV
Nickel lucido
Polished nickel



PGS | forte®
Grafite satinato
Satin graphite



PVD-BG | forte®
Oro antico lucido
Antique bright gold



PVD-SG | forte®
Oro antico satinato
Antique satin gold



PVD-SCB | forte®
Rame satinato
Satin copper

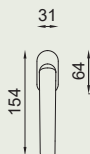
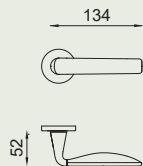

VIS VV12

FINE VV40

U VV80

VIS VV22V

U VV22TS

U VV22U

Luca Nichetto



Designer originario di Venezia, è attivo a livello internazionale ed è specializzato in design industriale, design del prodotto e consulenza. I suoi due studi si trovano a Venezia – dal 2006 – e in Svezia, a Stoccolma – dal 2011. Ha ricevuto numerosi premi internazionali per i suoi progetti, che spaziano tra prodotti, mobili e accessori, oltre a integrare architettura e design espositivo. Tra i marchi dei suoi progetti, Arflex, Cassina, De La Espada, Foscarini, Hermès, Molteni & C, Tubes, Venini, Wittmann.

Designer originally from Venice, he works on an international basis and specialises in industrial design, product design and design consultancy. His two studios are based in Italy in Venice – from 2006 – and in Sweden – from 2011. He has been awarded numerous international design awards for his projects, which range across products, furniture and accessories, as well as incorporating architecture and exhibition design. Among the brands of his projects, Arflex, Cassina, De La Espada, Foscarini, Hermès, Molteni & C, Tubes, Venini, Wittmann.

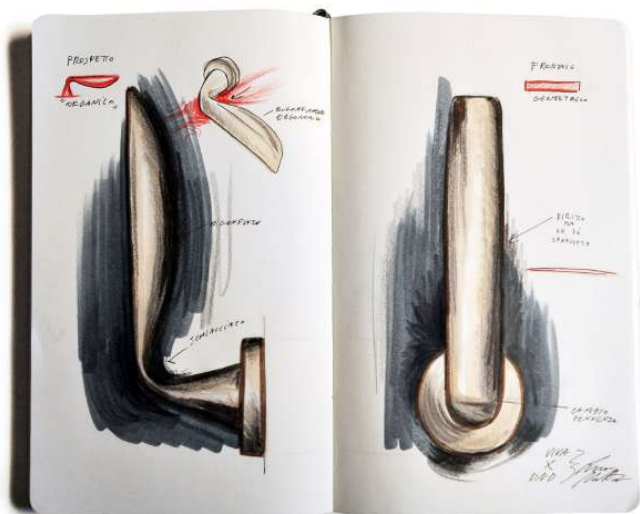

Vival
Disegni della maniglia di /
Handle sketches by
Luca Nichetto



Luca Collection, Bernhardt Design (2019)



Fusa, Svenskt Tenn (2019)



Elysia, De La Espada (2014)

zeppelin





Volumi marcati e arrotondati come rimando formale - e decorativo - ai dirigibili Zeppelin dell'inizio del 1900, per una maniglia contemporanea, dalla sapiente realizzazione tecnica.

Pronounced rounded volumes as a formal - and decorative - reference to the Zeppelin airships of the early 1900s, for a contemporary handle made with great technical prowess.

zeppelin

design:
Jaime Hayon

made in italy



ZP12
ONV

150-

dnd22-23

Ottone forgiato
Forged brass



ONV
Nickel lucido
Polished nickel



OVE
Verde
Green



ONO
Nero
Black



PGS | forte®
Grafite satinato
Satin graphite



PVD-BG | forte®
Oro antico lucido
Antique bright gold



PVD-SG | forte®
Oro antico satinato
Antique satin gold



PVD-SCB | forte®
Rame satinato
Satin copper

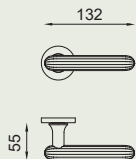

VIS ZP12

U ZP80

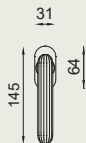

VIS ZP22V

U ZP22TS

U ZP22U

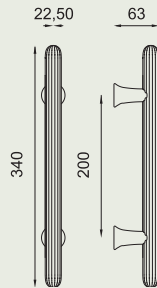

ZP27 singolo

ZP28 set

Jaime Hayon



Artista-designer originario di Madrid, ha aperto il suo studio a Valencia nel 2010.

Con uffici in Spagna, Italia e Giappone, progetta per Fritz Hansen, Bosa, Cassina, BD Barcelona, Wittmann, Magis, Ceccotti, &Tradition, Baccarat, Paola C, Bisazza, Lladro, Vicarbe, Arflex, Nani Marquina, Vista Alegre, Parachilna.

Ha vinto numerosi premi internazionali ed è stato incluso da Wallpaper Magazine nella lista "Top 100", riconosciuto come uno dei creatori più influenti dell'ultimo decennio.

Artist-designer originally from Madrid, opened his studio in Valencia in 2010.

With offices in Spain, Italy and Japan, he designs for Fritz Hansen, Bosa, Cassina, BD Barcelona, Wittmann, Magis, Ceccotti, &Tradition, Baccarat, Paola C, Bisazza, Lladro, Vicarbe, Arflex, Nani Marquina, Vista Alegre, Parachilna.

He has won numerous awards and he has been included by Wallpaper Magazine in its "Top 100" list, recognised by the magazine as one of the most influential creators of the last decade.

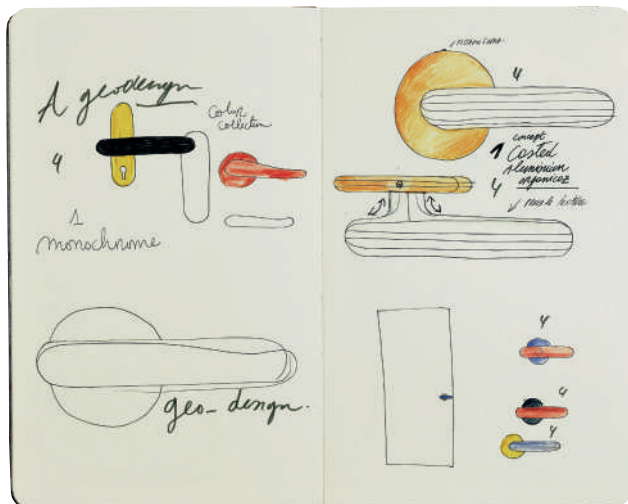

Zeppelin
Disegni della maniglia di /
Handle sketches by
Jaime Hayon



La Terraza del Casino, Madrid/Spain (2018)



Camper shop, Tokyo/Japan (2009)



Aballs Lamps, Parachilna (2013)

madeleine

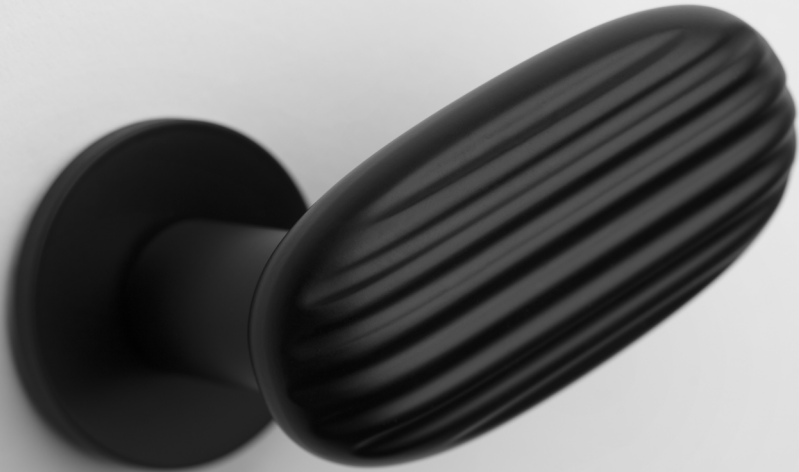



Un omaggio alla dolce
madeleine d'oltralpe
in una piccola maniglia
decorata che ne
riprende la forma
a conchiglia.

*A tribute to the
famous madeleine
cakes from beyond
the Alps, in a small
decorated handle
that replicates their
seashell form.*

madeleine

design:
Inga Sempé

made in italy



MA40
PVD-BG | forte®

Ottone stampato a caldo
Hot stamped brass



ONV
Nickel lucido
Polished nickel



ONO
Nero
Black



PGS | forte®
Grafite satinato
Satin graphite



PVD-BG | forte®
Oro antico lucido
Antique bright gold



PVD-SG | forte®
Oro antico satinato
Antique satin gold



PVD-SCB | forte®
Rame satinato
Satin copper



VIS MA12

FINE MA40

U MA80

VIS MA22V

U MA22TS

U MA22U

Inga Sempé



Nata a Parigi, nel 2000 è stata borsista a Villa Medici, presso l'Académie de France di Roma e, nello stesso anno, ha aperto il suo studio parigino. Le sue prime collaborazioni sono state con Edra e Cappellini. Oggi lavora con diverse aziende francesi, scandinave e italiane, tra le quali HAY, Ligne Roset, Wästberg, Magis, Alessi, Luceplan, Mutina, Crane, Røros, Moustache, Svenskt Tenn, Gärsnäs.

Born in Paris, she was a fellow at Villa Medici in 2000, at the Académie de France in Rome and opened her Paris studio in the same year. Her first collaborations were with Edra and Cappellini. Today she works with several French, Scandinavian and Italian companies, including HAY, Ligne Roset, Wästberg, Magis, Alessi, Luceplan, Mutina, Crane, Røros, Moustache, Svenskt Tenn, Gärsnäs.



Pandarine, Hay (2020)



Lampes, Moustache (2012)



Herringbone, Crane (2017)



w153, Wästberg (2015)

boole





Due cilindri si incontrano e si intersecano con il leggero slittamento di uno rispetto all'altro, nella condivisione di una piccola, comune porzione di materia.

Two cylinders meet and intersect with a slight shift, sharing a small portion of material.

boole

design:
Odo Fioravanti

made in italy



BE40
OC

162-

dnd22-23

Ottone stampato a caldo
Hot stamped brass



OC
Power cromo lucido
Power polished chrome



PCS
Power cromo satinato
Power satin chrome



ONO
Nero
Black



PGS | forte®
Grafite satinato
Satin graphite



PVD-SG | forte®
Oro antico satinato
Antique satin gold



PVX | forte®
Inox satinato
Satin steel

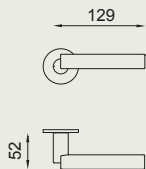

VIS BE12

FINE BE40

U BE80

VIS BE22V

U BE22TS

U BE22U

Odo Fioravanti



Dal 2003, con base a Milano, lavora come industrial designer sperimentando anche la grafica e l'exhibition design. I suoi oggetti sono stati esposti in molte mostre internazionali e nel 2010 il Design Museum della Triennale di Milano ha dedicato al suo lavoro la personale "Industrious Design". Nel 2011 ha vinto il Compasso d'Oro ADI con la sedia in legno Frida di Pedrali.

Tra i suoi clienti, Alpi, Flou, Fontana Arte, Foscarini, Land Rover, Maison 203, Normann Copenhagen, Pedrali, Toshiba, Vibram, Victorinox.

Since 2003, based in Milan, he has been working as an industrial designer, while experimenting also with graphic and exhibition design. His objects have been shown in many international exhibitions and in 2010 the Design Museum of the Triennale di Milano dedicated to his work the solo exhibition "Industrious Design". In 2011 he won the Compasso d'Oro ADI award with the Frida wooden chair by Pedrali.

Among his clients, Alpi, Flou, Fontana Arte, Foscarini, Land Rover, Maison 203, Normann Copenhagen, Pedrali, Toshiba, Vibram, Victorinox.

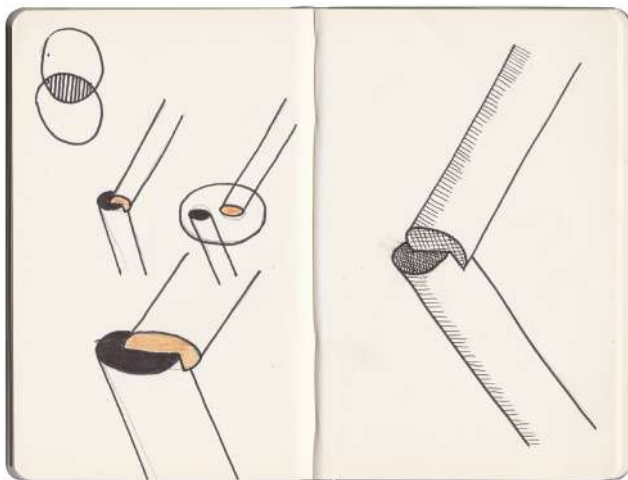

Boole
Disegni della maniglia di /
Handle sketches by
Odo Fioravanti



Bern clutch, Maison 203 (2017)



Frida, Pedrali (2008)



Volée, FontanaArte (2016)

safety





Un nastro di metallo
si fa maniglia
ripiegandosi sul finale,
per assicurare una
buona e sicura presa.

*A metal ribbon
becomes a handle,
bending at its end
to provide a sure,
safe grip.*

safety

design:
Enrico Martini

made in italy



SA40
PCS

168-

dnd22-23

Ottone stampato a caldo
Hot stamped brass



PCS
Power cromo satinato
Power satin chrome



ONO
Nero
Black



PGS | forte®
Grafite satinato
Satin graphite



PVD-SG | forte®
Oro antico satinato
Antique satin gold



PVD-SCB | forte®
Rame satinato
Satin copper



PVX | forte®
Inox satinato
Satin steel

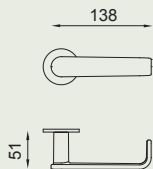

VIS SA12

52 SA16

FINE SA40

VIS SA22V

🔒 SA22TS

iki





Una costruzione formale palindroma: il profilo della vista superiore è identico a quello della vista frontale, ribaltato di 180 gradi. Una forma elegante ed essenziale, un volume mutevole che suggerisce all'utente la presa con il suo profilo frontale.

A palindromic structural form: the profile in the view from above is identical to that of the frontal view, but reversed by 180 degrees. An elegant and essential form, a mutable volume that suggests the proper grip with its frontal profile.

iki

design:
Mario Sciarato
Alessandro Stabile

made in italy



IK12
ZAN

172-

dnd22-23

Zama
Zamak



ZCS
Cromo satinato
Satin chrome



ZNE
Nero
Black



ZAN
Antracite
Anthracite

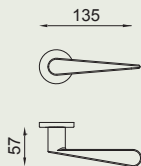

VIS IK12

FINE IK40

U IK80

VIS IK22V

U IK22TS

U IK22U

Mario Scairato



Vive e lavora tra Milano e Paestum, la città da cui proviene. Si è laureato in Industrial Design allo IUAV / Università della Repubblica di San Marino nel 2011 e dal 2015 ha disegnato per diversi marchi, tra cui Alessi, Internoitaliano e Moleskine. Dal 2015 è art director di Paestum Experience, un progetto di branding da lui fondato che mira alla promozione e alla comunicazione della città di Capaccio Paestum.

He lives and works between Milan and Paestum, his hometown. He graduated in Industrial Design at the IUAV / Università della Repubblica di San Marino in 2011. Since 2015 he has designed for some brands including Alessi, Internoitaliano and Moleskine.

He has been art director of Paestum Experience since 2015, a branding project he founded that aims to promote and communicate the city of Capaccio Paestum.

Alessandro Stabile



Originario di Milano, è uno dei dieci "Top Young Italian Industrial Designers" selezionati dall'Istituto Italiano di Cultura di New York nel 2013.

Nel 2011 ha fondato il suo studio ed è specializzato in product design e direzione artistica.

Nel 2016 due suoi progetti hanno vinto il primo e il secondo premio Young&Design come i due migliori prodotti presentati alla Milano Design Week da un under 35. Disegna per diversi brand tra cui Moleskine, Alessi, Ferrero Nutella.

Originally from Milan, he is one of the ten "Top Young Italian Industrial Designers" selected by the Italian Cultural Institute in New York in 2013.

In 2011 he founded his design studio specialising in product design and artistic direction.

In 2016 two of his ideas won the first and the second prizes of the Young&Design Award, as the best projects of Milan Design Week from an under 35. He designs for different brands such as Moleskine, Alessi, Ferrero Nutella.



Scairato: Cave + Gioi, Internoitaliano (2017)
 Stabile: Hard luggage, Moleskine (2019)
 Scairato+Stabile: Pen + Ellipse, Moleskine (2018)

IKI
 Disegni della
 maniglia di /
 Handle sketches by
 Mario Scairato+
 Alessandro Stabile

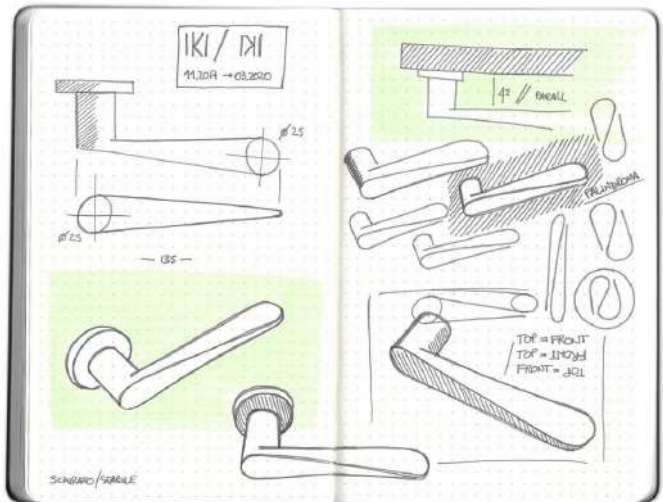

ginkgo





Una forma di ispirazione naturale, quale la bellissima foglia del Ginkgo, si fa struttura e decoro per una maniglia che nasce in due diverse versioni.

A form based on nature, the special, unique shape of a Ginkgo leaf, becomes the structure and decoration of a handle that is made in two different versions.

ginkgo

design:
Giulio lacchetti

made in italy



GK40
PVD-SG | forte®

178-

dnd22-23

Ottone stampato a caldo
Hot stamped brass



OC
Power cromo lucido
Power polished chrome



PCS
Power cromo satinato
Power satin chrome



ONV
Nickel lucido
Polished nickel



ONO
Nero
Black



PGS | forte®
Grafite satinato
Satin graphite



PVD-BG | forte®
Oro antico lucido
Antique bright gold



PVD-SG | forte®
Oro antico satinato
Antique satin gold



**Good Design Awards
2017**

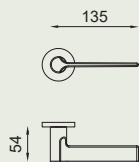

VIS GK12

FINE GK40

U GK80



VIS GK22V

U GK22TS

U GK22U

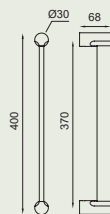

GK27 - singolo

GK28 - set



GK29 - singolo

GK30 - set

ginkgo biloba



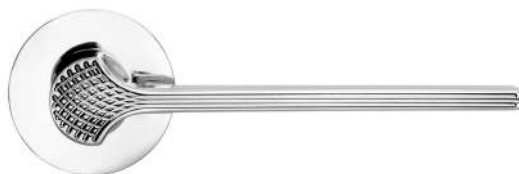

Ginkgo Biloba, la versione della maniglia Ginkgo con l'incisione in superficie, è un ulteriore rimando metaforico alle venature della foglia.

Ginkgo Biloba, the version of the Ginkgo handle with the decorative surface engraving, is a further metaphorical reminder of the veins of the leaf.

ginkgo biloba

design:
Giulio lacchetti

made in italy



GB40
PVD-BG | forte®

182-

dnd22-23

Ottone stampato a caldo
Hot stamped brass



OC
Power cromo lucido
Power polished chrome



PCS
Power cromo satinato
Power satin chrome



ONV
Nickel lucido
Polished nickel



ONO
Nero
Black



PGS | forte®
Grafite satinato
Satin graphite



PVD-BG | forte®
Oro antico lucido
Antique bright gold



PVD-SG | forte®
Oro antico satinato
Antique satin gold



**Good Design Awards
2017**

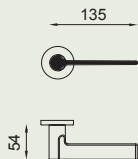

VIS GB12

FINE GB40

U GB80



VIS GB22V

U GB22TS

U GB22U

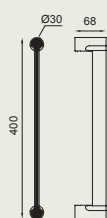

GB27 - singolo

GB28 - set

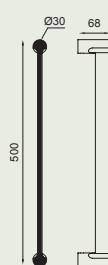

GB29 - singolo

GB30 - set

timeless



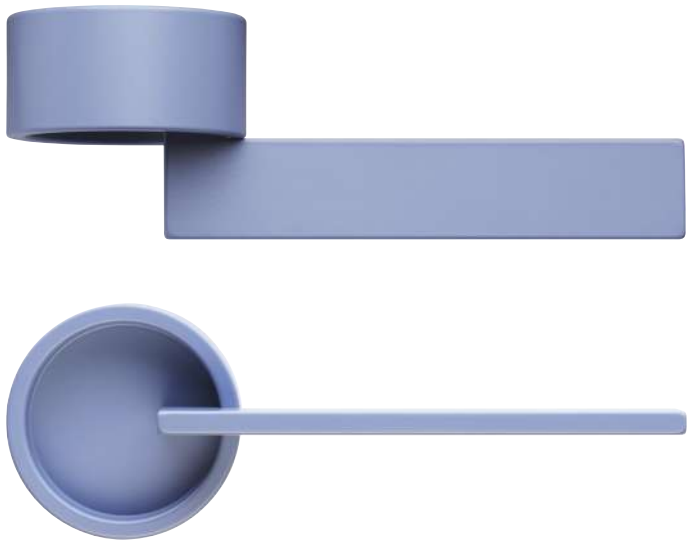

Due segni grafici
essenziali, una linea
e un cerchio che
si intersecano in
maniera centrale e
simmetrica.

*Two essential graphic
signs, a line and
a circle that intersect
in a central and
symmetrical way.*

timeless

design:
Marco Pisati

made in italy



TL01
AVP

186-

dnd22-23

Alluminio
Aluminium



ASV
Silver
Silver



ARO
Oro satinato
Satin gold



ABR
Bronzo
Bronze



ABN
Bianco
White



ANE
Nero
Black



ABT new
Turchese
Turquoise



AGO new
Giallo oliva
Yellow olive



AVP new
Violetto pastello
Pastel violet



ABC new
Blu colomba
Blue dove

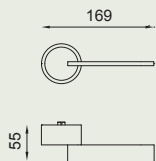

FINE TL01



Pomolo
Knob

FINE TL40 - set
TL39 - singolo



Pomolino per mobili
Knob furniture

FINE TL70

isabella





Un cilindro e lievi
modanature, tra forme
classiche e volumi
moderni.

*A cylinder and slight
moldings, between
classical forms and
modern volumes.*

isabella

design:
Marco Pisati

made in italy



IS13
OC

190-

dnd22-23

Ottone stampato a caldo
Hot stamped brass



OGH
Bronzo satinato opaco
Matt satin bronze



OC
Power cromo lucido
Power polished chrome



ONV
Nickel lucido
Polished nickel



PGS | forte®
Grafite satinato
Satin graphite



PVD-BG | forte®
Oro antico lucido
Antique bright gold



PVD-SG | forte®
Oro antico satinato
Antique satin gold

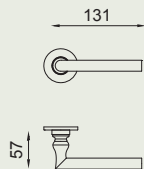

- R** IS13
- FINE** IS40
- U** IS80

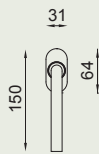

- VIS** IS22V
- U** IS22TS
- U** IS22U

lucrezia





Rimandi rinascimentali nel bel modellato dello stelo, a cui si aggiunge il disegno dell'impugnatura: una forma rettangolare alleggerita da un'elegante modanatura a caratterizzarne il bordo.

Renaissance references in the fine shaping of the stem, joined by the design of the grip: a rectangular form lightened by elegant shaped borders.

lucrezia

design:
Marco Pisati

made in italy



LT13
PVD-BG | forte®

Ottone forgiato
Forged brass



OGH
Bronzo satinato opaco
Matt satin bronze



ONV
Nickel lucido
Polished nickel



PGS | forte®
Grafite satinato
Satin graphite



PVD-BG | forte®
Oro antico lucido
Antique bright gold



PVD-SG | forte®
Oro antico satinato
Antique satin gold

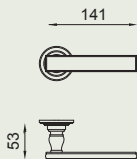

FINE LT40

R LT13



VIS LT30V

🔒 LT30TS

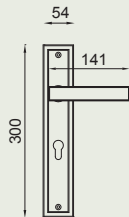

LT10

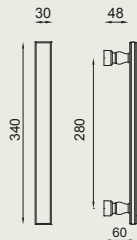

LT27*

* Altre misure disponibili
su richiesta.
*Other lengths available
on request.*

lucrezia 02

design:
Marco Pisati

made in italy



LT41
ONV

196-

dnd/22-23

Ottone forgiato
Forged brass



OGH
Bronzo satinato opaco
Matt satin bronze



ONV
Nickel lucido
Polished nickel



PGS | forte®
Grafite satinato
Satin graphite



PVD-BG | forte®
Oro antico lucido
Antique bright gold



PVD-SG | forte®
Oro antico satinato
Antique satin gold

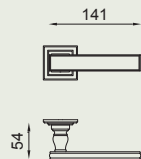

FINE LT41

R LT14

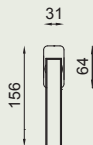

VIS LT31V

🔒 LT31TS

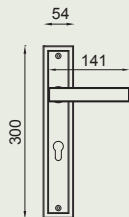

LT10

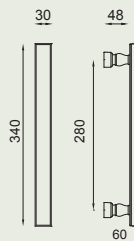

LT27*

* Altre misure disponibili
su richiesta.
*Other lengths available
on request.*

ginevra

design: Dnd
technical division

made in italy



G19
PVD-SG | forte®

198-

dnd22-23

Ottone forgiato
Forged brass



OGH
Bronzo satinato opaco
Matt satin bronze



ONV
Nickel lucido
Polished nickel



PGS | forte®
Grafite satinato
Satin graphite



PVD-BG | forte®
Oro antico lucido
Antique bright gold



PVD-SG | forte®
Oro antico satinato
Antique satin gold

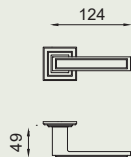

R GI19

FINE GI41

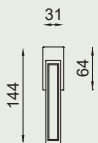

R GI22V

🔒 GI22TS

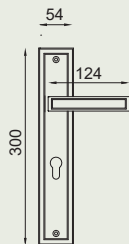

GI10

C-1918





Una maniglia – e una serie – d'autore caratterizzata dalla sapiente unione di acciaio e rame. Un progetto inedito, riscoperto e prodotto da Dnd con grande orgoglio.

A signature handle – and series – based on the felicitous combination of steel and copper. An original project, rediscovered and produced with great pride by Dnd.

C-1918

design:
Achille Castiglioni
Gianfranco Cavaglia

made in italy



CC12
L316 + R

202-

dnd22-23

Acciaio inox AISI 316 + rame
AISI Stainless steel 316 + copper



S316 + R
 AISI 316 satinato
 + inserto rame PVD
AISI 316 satin
 + PVD copper insert



L316 + R
 AISI 316 lucido
 + inserto rame PVD
AISI 316 polished
 + PVD copper insert



S316 + N
 AISI 316 satinato
 + inserto rame nero
AISI 316 satin
 + copper black insert



L316 + N
 AISI 316 lucido
 + inserto rame nero
AISI 316 polished
 + copper black insert

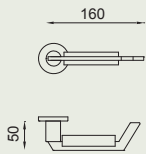

VIS CC12

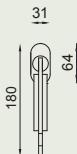

CC22

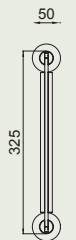

CC25



CC27

intake





Disegnata per il Museo Casa Enzo Ferrari di Modena, solida nella materia e plastica nella forma, è un omaggio al car design più attento.

Designed for the Enzo Ferrari Museum in Modena, solid in terms of material, sculptural in terms of form, in a tribute to the finest automotive design.

intake

design:
Andrea Morgante

made in italy



IN14
ONO

206-

dnd22-23

Ottone stampato a caldo
Hot stamped brass



OC
Power cromo lucido
Power polished chrome



OBN
Bianco
White



ONO
Nero
Black

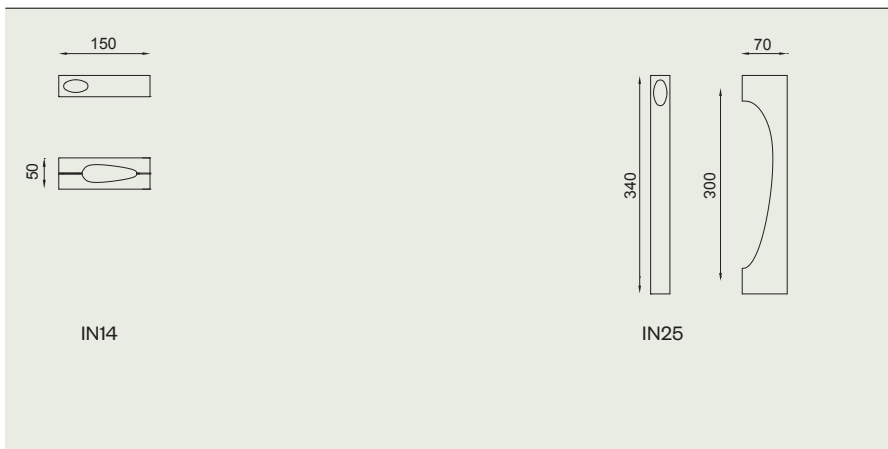

luxury

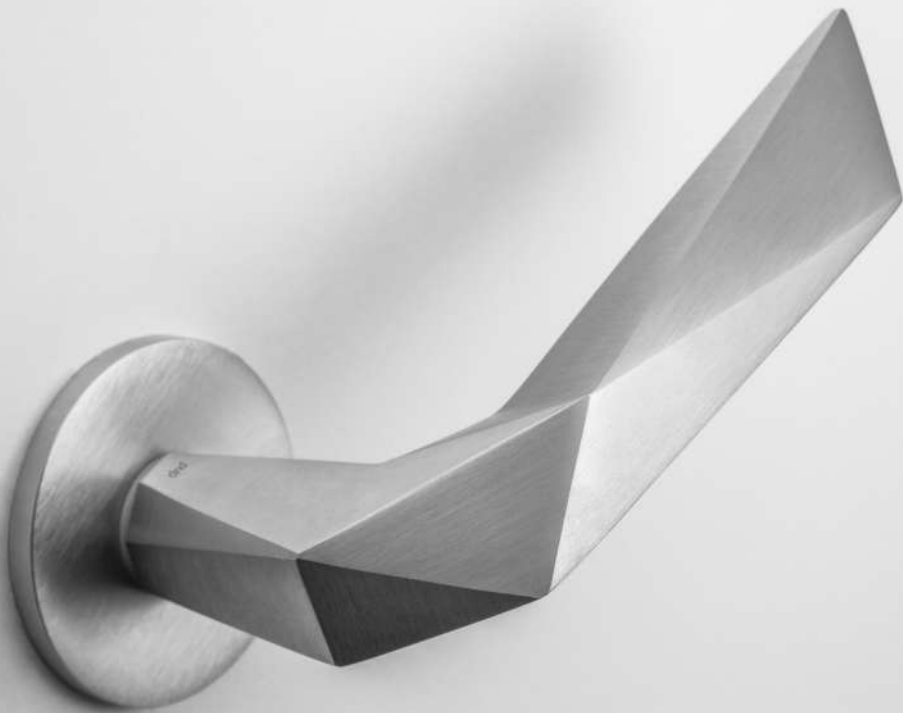



Geometrie sfaccettate e tagli netti nella materia rimandano a celebri episodi dell'architettura contemporanea.

Faceted geometry and clean cuts in the material evoke famous episodes of contemporary architecture.

luxury

design:
Mauro Ronchi

made in italy

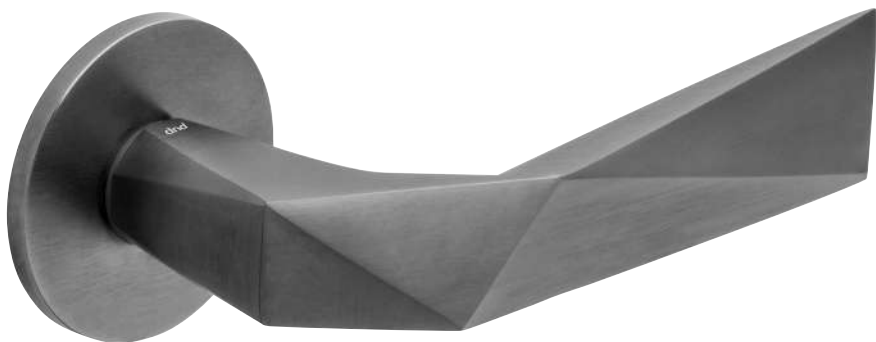

LU40
PGS|forte®

210-

dnd22-23

Ottone stampato a caldo
Hot stamped brass



OGH
Bronzo satinato opaco
Matt satin bronze



OC
Power cromo lucido
Power polished chrome



PCS
Power cromo satinato
Power satin chrome



ONO
Nero
Black



PGS | forte®
Grafite satinato
Satin graphite



PVD-BG | forte®
Oro antico lucido
Antique bright gold



PVD-SG | forte®
Oro antico satinato
Antique satin gold



PVD-SCB | forte®
Rame satinato
Satin copper

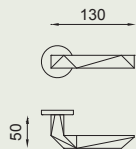

VIS LU12

52 LU16

FINE LU40

U LU80



VIS LU22V

U LU22TS

U LU22U

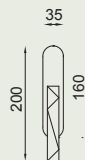

LU20C

LU21M

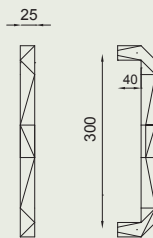

LU27

luxury 02

design:
Mauro Ronchi

made in italy

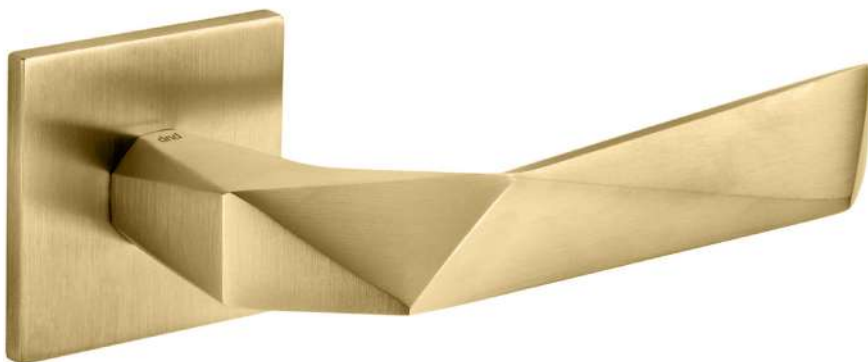

LU41
PVD-SG | forte®

Ottone stampato a caldo
Hot stamped brass



OGH
Bronzo satinato opaco
Matt satin bronze



OC
Power cromo lucido
Power polished chrome



PCS
Power cromo satinato
Power satin chrome



ONO
Nero
Black

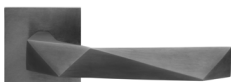

PGS | forte®
Grafite satinato
Satin graphite



PVD-BG | forte®
Oro antico lucido
Antique bright gold



PVD-SG | forte®
Oro antico satinato
Antique satin gold



PVD-SCB | forte®
Rame satinato
Satin copper

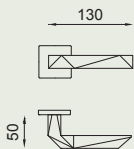

VIS LU14

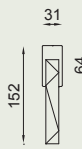

R LU25

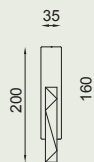

LU23C

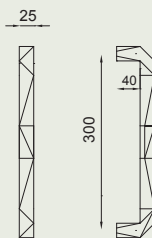

LU27

FINE LU41

VIS LU25V

LU24M

52 LU18

🔒 LU25TS

aretè



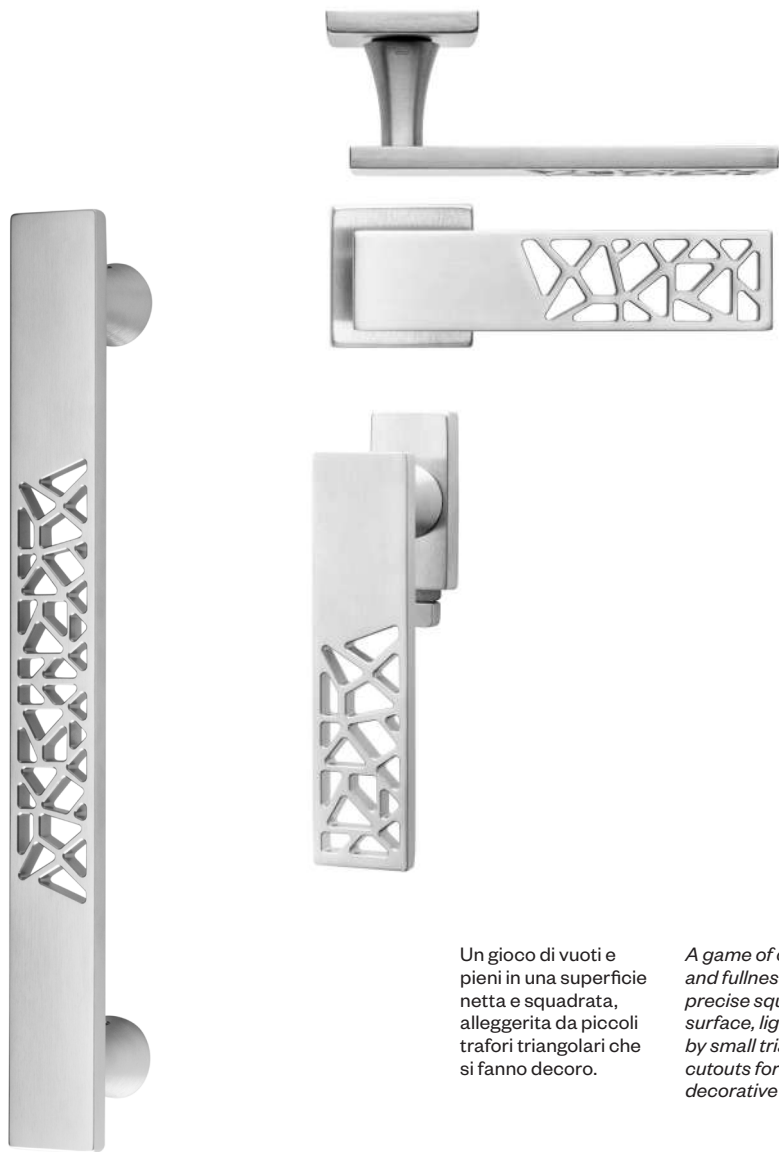

Un gioco di vuoti e pieni in una superficie netta e squadrata, alleggerita da piccoli trafori triangolari che si fanno decoro.

A game of openness and fullness in a precise squared surface, lightened by small triangular cutouts for a decorative touch.

aretè

design:
Mauro Ronchi

made in italy

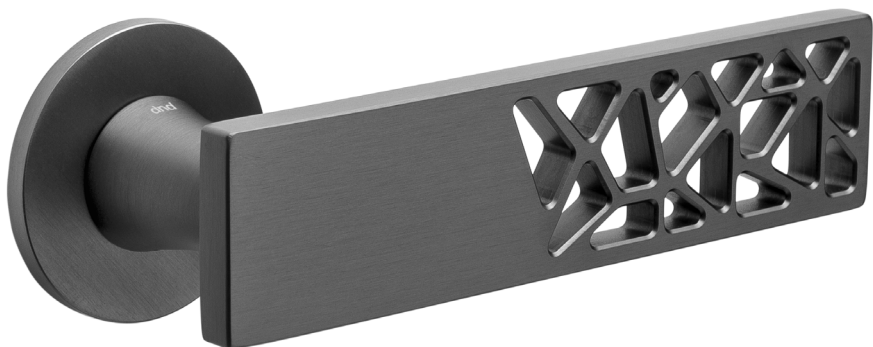

AT40
PGS|forte®

216-

dnd22-23

Ottone forgiato
Forged brass



AB
Bronzato
Antique bronze



OGH
Bronzo satinato opaco
Matt satin bronze



OC
Power cromo lucido
Power polished chrome



PCS
Power cromo satinato
Power satin chrome



PGS | forte®
Grafito satinato
Satin graphite



PVD-SG | forte®
Oro antico satinato
Antique satin gold



PVX | forte®
Inox satinato
Satin steel

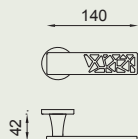

VIS AT12

FINE AT40

62 AT16

U AT80

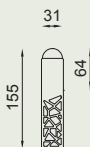

VIS AT22V

🔒 AT22TS

U AT22U

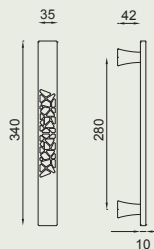

AT27* - singolo

AT28* - set

* Altre misure disponibili
su richiesta.
*Other lengths available
on request.*

aretè 02

design:
Mauro Ronchi

made in italy



AT41
OC

218-

dnd/22-23

Ottone forgiato
Forged brass



AB
Bronzato
Antique bronze



OGH
Bronzo satinato opaco
Matt satin bronze



OC
Power cromo lucido
Power polished chrome



PCS
Power cromo satinato
Power satin chrome



PGS | forte®
Grafite satinato
Satin graphite



PVD-SG | forte®
Oro antico satinato
Antique satin gold



PVX | forte®
Inox satinato
Satin steel

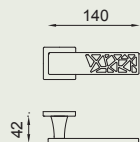

VIS AT14

FINE AT41

52 AT18

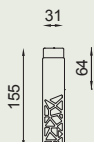

R AT25

VIS AT25V

🔒 AT25TS

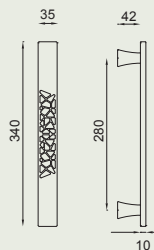

AT27* - singolo

AT28* - set

* Altre misure disponibili
su richiesta.
*Other lengths available
on request.*

aretè L





Il nitore di una geometria classica dal sapore contemporaneo: una maniglia che parla di sofisticata semplicità.

The clarity of classical geometry with a contemporary mood: a handle that speaks of sophisticated simplicity.

aretè L

design:
Mauro Ronchi

made in italy



AL40
OGH

222-

dnd22-23

Ottone forgiato
Forged brass



AB
Bronzato
Antique bronze



OGH
Bronzo satinato opaco
Matt satin bronze



OC
Power cromo lucido
Power polished chrome



PCS
Power cromo satinato
Power satin chrome



PGS | forte®
Grafite satinato
Satin graphite



PVD-SG | forte®
Oro antico satinato
Antique satin gold



PVX | forte®
Inox satinato
Satin steel

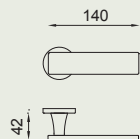

VIS AL12

52 AL16

FINE AL40

U AL80

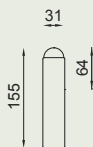

VIS AL22V

U AL22TS

U AL22U

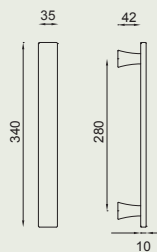

AL27* - singolo
AL28* - set

* Altre misure disponibili
su richiesta.
*Other lengths available
on request.*

aretè L 02

design:
Mauro Ronchi

made in italy



AL14
PCS

224-

dnd22-23

Ottone forgiato
Forged brass



AB
Bronzato
Antique bronze



OGH
Bronzo satinato opaco
Matt satin bronze



OC
Power cromo lucido
Power polished chrome



PCS
Power cromo satinato
Power satin chrome



PGS | forte®
Grafito satinato
Satin graphite



PVD-SG | forte®
Oro antico satinato
Antique satin gold



PVX | forte®
Inox satinato
Satin steel

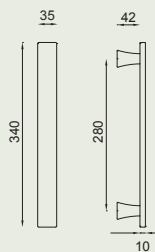
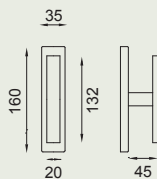
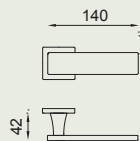

VIS AL14

R AL25

ED26C

AL27* - singolo

FINE AL41

VIS AL25V

ED26M

AL28* - set

52 AL18

🔒 AL25TS

* Altre misure disponibili
su richiesta.
*Other lengths available
on request.*

cloe



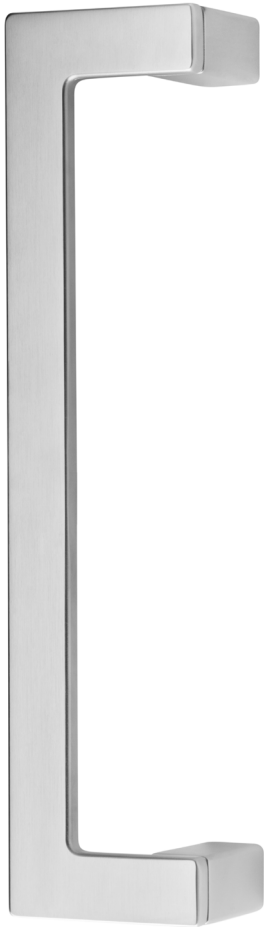

Un triangolo scolpito e rigoroso, geometrie nitide per una maniglia dedicata ad ambienti minimali ed essenziali.

A rigorously sculpted triangle, a clear geometric form in a handle designed for essential, minimal spaces.

cloe

**design: Dnd
technical division**

made in italy



CL40
PGS|forte®

228-

dnd22-23

Ottone stampato a caldo
Hot stamped brass



OC
Power cromo lucido
Power polished chrome



PCS
Power cromo satinato
Power satin chrome



PGS | forte®
Grafite satinato
Satin graphite



PVD-BG | forte®
Oro antico lucido
Antique bright gold



PVD-SG | forte®
Oro antico satinato
Antique satin gold

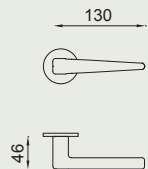

VIS CL12

FINE CL40

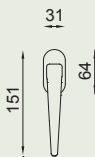

VIS CL22V

🔒 CL22TS



CL27 - 300 mm

CL29 - 500 mm

cloe 02

design: Dnd
technical division

made in italy



CL41
PVD-BG | forte®

230-

dnd/22-23

Ottone stampato a caldo
Hot stamped brass



OC
Power cromo lucido
Power polished chrome



PCS
Power cromo satinato
Power satin chrome



PGS | forte®
Grafite satinato
Satin graphite



PVD-BG | forte®
Oro antico lucido
Antique bright gold



PVD-SG | forte®
Oro antico satinato
Antique satin gold

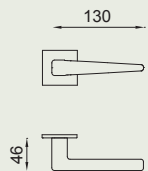

VIS CL14

FINE CL41

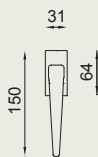

VIS CL25V

🔒 CL25TS

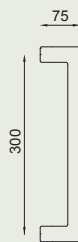

CL27 - 300 mm

CL29 - 500 mm

change B 02

design:
Sandro Santantonio

made in italy

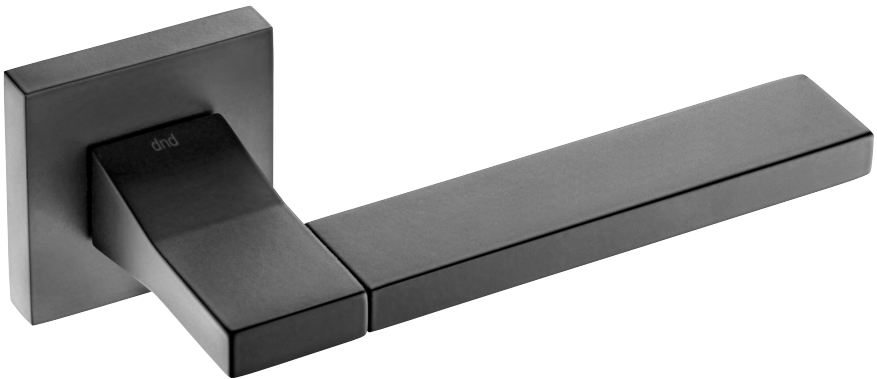

CB18
ONO

232-

dnd22-23

Ottone stampato a caldo
Hot stamped brass



PCS new
Power cromo satinato
Power satin chrome



CCS
Cromo - Power cromo satinato
Chrome - Power satin chrome



OBN
Bianco
White



ONO
Nero
Black



V702
Marrone scuro
Dark brown

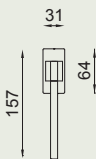
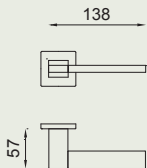

VIS CB14

52 CB18

S CB63

R CB25

🔒 CB25TS

edra 02



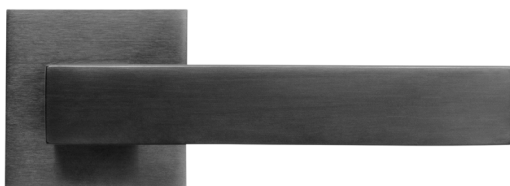

La forza di una forma
archetipica: l'idea
stessa di maniglia
si concretizza in
geometrie e volumi di
essenziale purezza.

*The force of
archetypal form: the
idea of the handle
itself embodied by
geometric lines and
volumes of essential
purity.*

edra 02

design:
Mauro Ronchi

made in italy

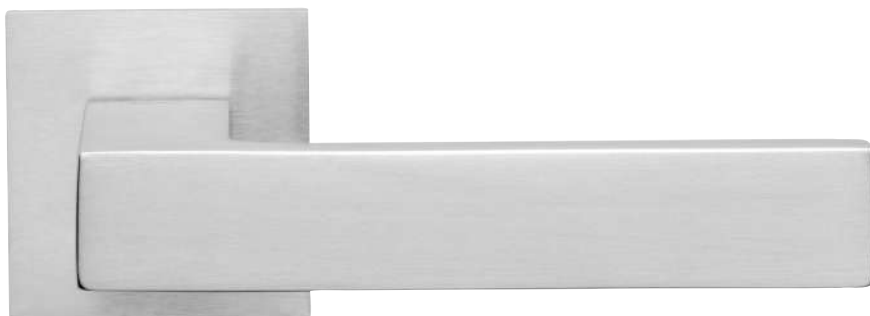

ED41
PCS

236-

dnd22-23

Ottone stampato a caldo
Hot stamped brass



OGH
Bronzo satinato opaco
Matt satin bronze



OC
Power cromo lucido
Power polished chrome



PCS
Power cromo satinato
Power satin chrome



ONO
Nero
Black



ONS
Nickel satinato
Satin nickel

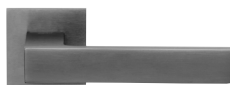

PGS | forte®
Grafite satinato
Satin graphite



PVX | forte®
Inox satinato
Satin steel



PVD-SG | forte®
Oro antico satinato
Antique satin gold



PVD-SCB | forte®
Rame satinato
Satin copper

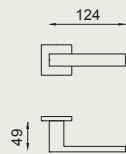

VIS ED14

FINE ED41

52 ED18

R ED63



R ED25

VIS ED25V

🔒 ED25TS

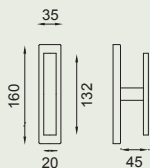

ED26C

ED26M

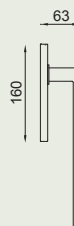

ED60



L025

fluke





Una forma dinamica che nasce dall'incontro di due volumi troncoconici contrapposti: il segno forte di un design riconoscibile e riconosciuto.

A dynamic form that arises from the meeting of two opposing cones: the vivid impact of a recognizable design.

fluke

design:
Karim Rashid

made in italy



FK14
PCS

240-

dnd22-23

Ottone stampato a caldo
Hot stamped brass



OC
Power cromo lucido
Power polished chrome



PCS
Power cromo satinato
Power satin chrome

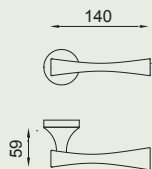

FINE FK40

R FK14

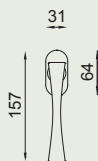

VIS FK22V

LOCK FK22TS

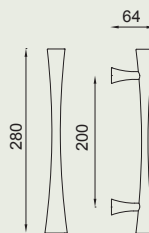

FK27

luce p **NEW**





Una leva dalle geometrie solide e pulite, disegnate e costruite con attenzione intorno a un angolo di 90 gradi. Presa ergonomica e appeal contemporaneo, con la luce che enfatizza i profili.

A lever with solid, clean geometries, carefully designed and constructed around a 90-degree angle. Ergonomic grip and contemporary appeal, with light emphasising the profiles.

luce p

design:
Dnd technical
division

made in italy



LP12
ZOS

244-

dnd22-23



ZOS
Ottonato satinato
Satin brass color



ZGH
Bronzo satinato opaco
Matt satin bronze



ZC
Cromo lucido
Polished chrome



ZCS
Cromo satinato
Satin chrome



ZNS
Nickel satinato
Satin nickel



ZNE
Nero
Black



ZBN
Bianco
White



ZAN
Antracite
Anthracite

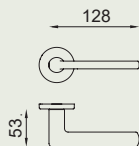

VIS LP12

FINE LP40

S LP62

U LP80

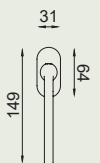

VIS LP22V

U LP22TS

U LP22U

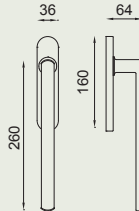

LC50



LC26 - singolo

LC28 - set

luce p 02

design:
Dnd technical
division

made in italy



LP14
ZNE

246-

dnd22-23



ZOS
Ottonato satinato
Satin brass color



ZGH
Bronzo satinato opaco
Matt satin bronze



ZC
Cromo lucido
Polished chrome



ZCS
Cromo satinato
Satin chrome



ZNS
Nickel satinato
Satin nickel



ZNE
Nero
Black



ZBN
Bianco
White



ZAN
Antracite
Anthracite

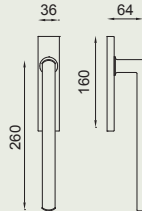
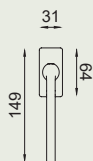
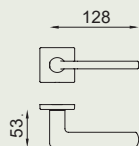

VIS LP14

VIS LP25V

LC60

LC26 - singolo

FINE LP41

 LP25TS

LC28 - set

S LP63

luce





La maniglia come fatto scultoreo, dove la luce evidenzia morbidezze e taglia i volumi in modo netto per restituirci l'idea stessa di un concetto plastico fuori dal tempo.

The handle as sculpture, where light brings out softness and volumes with clarity, conveying the idea of a timeless shaped object.

luce

**design: Dnd
technical division**

made in italy



LC12
ZNE

250-

dnd22-23

Zama
Zamak



ZOS
Ottonato satinato
Satin brass color



ZGH
Bronzo satinato opaco
Matt satin bronze



ZC
Cromo lucido
Polished chrome



ZNS
Nickel satinato
Satin nickel



ZCS
Cromo satinato
Satin chrome



ZNE
Nero
Black



ZBN
Bianco
White



ZAN
Antracite
Anthracite

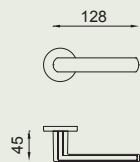

VIS LC12

FINE LC40

S LC62

U LC80



VIS LC30V

LC30TS

U LC30U

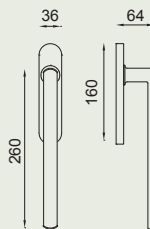

LC50



LC26 - singolo

LC28 - set

luce 02

design: Dnd
technical division

made in italy

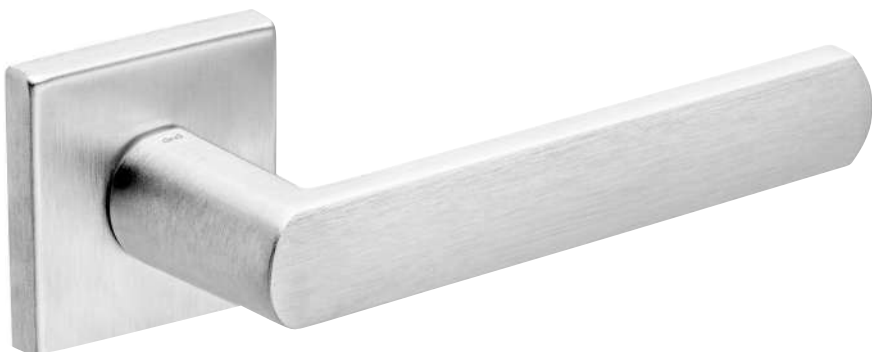

LC14
ZOS

252-

dnd/22-23

Zama
Zamak



ZOS
Ottonato satinato
Satin brass color



ZGH
Bronzo satinato opaco
Matt satin bronze



ZC
Cromo lucido
Polished chrome



ZNS
Nickel satinato
Satin nickel



ZCS
Cromo satinato
Satin chrome



ZNE
Nero
Black



ZBN
Bianco
White



ZAN
Antracite
Anthracite

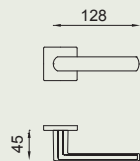

VIS LC14

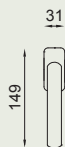

VIS LC31V

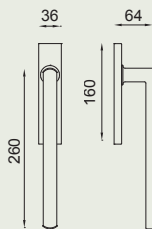

LC60



LC26 - singolo

FINE LC41

LC LC31TS

LC28 - set

S LC63

short





Linee morbide dall'appeal immediato. Una maniglia dal design compatto ed equilibrato, molto apprezzata per la sua versatilità di applicazione in termini di stile e finiture.

The immediate appeal of soft lines. A compact and balanced design defines this handle, very appreciated thanks to its versatility, both style and finishes.

short

design:
Karim Rashid

made in italy



SH40
OC

256-

dnd22-23

Ottone stampato a caldo
Hot stamped brass



AB
Bronzato
Antique bronze



OC
Power cromo lucido
Power polished chrome



PCS
Power cromo satinato
Power satin chrome



ONO
Nero
Black

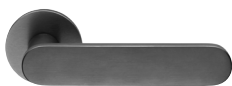

PGS | forte®
Grafite satinato
Satin graphite



PVD-SG | forte®
Oro antico satinato
Antique satin gold



PVD-SCB | forte®
Rame satinato
Satin copper

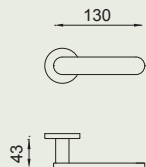

- VIS** SH12
- FINE** SH40
- U** SH80

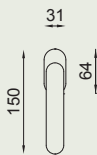

- VIS** SH22V
- 🔒** SH22TS
- U** SH22U

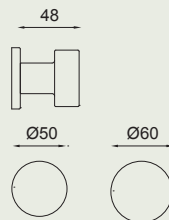

- VIS** RO43 - 50 mm
- RO39 - 60 mm

esa due





L'accostamento
di due diversi
materiali in un gioco
di sintesi formale e
compositiva.

*The combination of
two different materials
in a game of formal
and compositional
synthesis.*

esa due

**design: Dnd
technical division**

made in italy



**EU41
ONE**

260-

dnd22-23

Alluminio e zama
Aluminium and zamak



CCS

Cromo - Power cromo satinato
Chrome - Power satin chrome



CBI

Cromo - bianco
Chrome - white



CNE

Cromo - nero
Chrome - Black

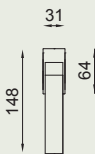
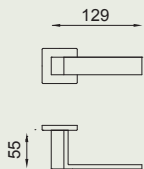

VIS EU14

VIS EU25V

FINE EU41

 EU25TS

esa

design:
Mauro Ronchi

made in italy



ES14
SBI

262-

dnd22-23

Alluminio e zama
Aluminium and zamak



CCS
Cromo - Power cromo satinato
Chrome - Power satin chrome



CBI
Cromo - bianco
Chrome - white



CNE
Cromo - nero
Chrome - Black



SBI new
Cromo satinato - bianco
Satin chrome - white



SNE new
Cromo satinato - nero
Satin chrome - black



ZNE new
Nero
Black

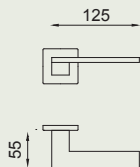

VIS ES14

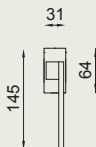

VIS ES25V

 ES25TS

holly

**design: Dnd
technical division**

made in italy

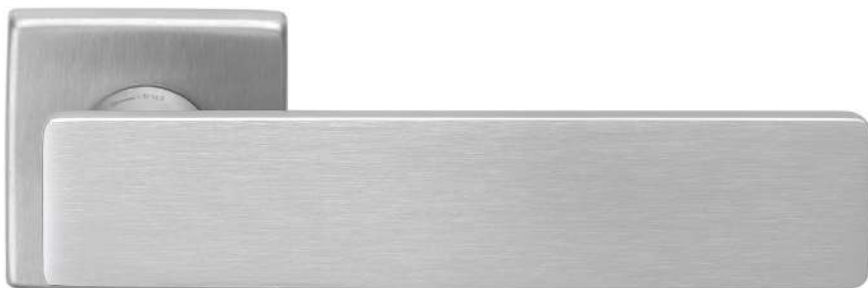

HO14
ZOS

264-

dnd22-23

Zama
Zamak



ZCS
Cromo satinato
Satin chrome



ZNE
Nero
Black



ZBN
Bianco
White

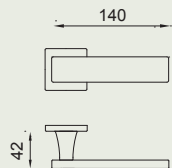

VIS HO14



VIS HO25V

 HO25TS

minima

design: Dnd
technical division

made in italy



MN12
ZONE

266-

dnd22-23

Zama
Zamak



ZCCS

Cromo lucido + cromo satinato
Polished chrome + satin chrome



ZCBI

Cromo lucido + bianco
Polished chrome + white



ZCNE

Cromo lucido + nero
Polished chrome + black

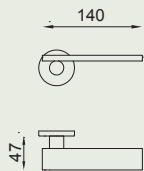

VIS MN12

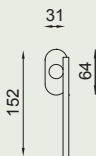

VIS MN22V

LOCK MN22TS

chop

design:
Didier Schweizer

made in italy



GP12
ZNE

268-

dnd22-23

Zama
Zamak



ZOS
Ottonato satinato
Satin brass color



ZGH
Bronzo satinato opaco
Matt satin bronze



ZC
Cromo lucido
Polished chrome



ZCS
Cromo satinato
Satin chrome



ZNE
Nero
Black



ZAN
Antracite
Anthracite

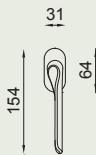
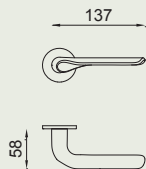

VIS CP12

U CP80

VIS CP22V

U CP22TS

U CP22U

fold

design:
Mario Padiglione

made in italy

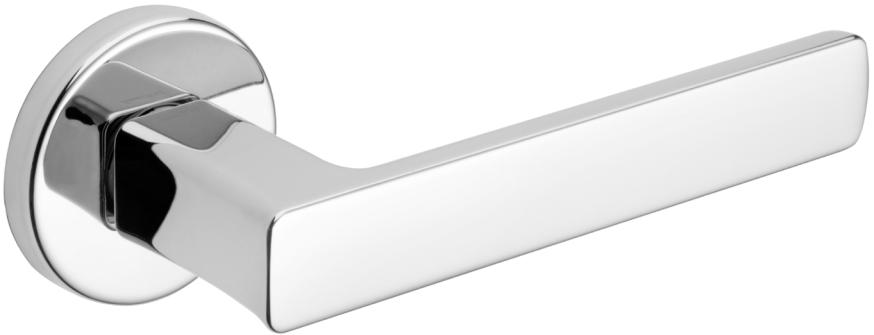

FO12
ZC

270-

dnd22-23

Zama
Zamak



ZC
Cromo lucido
Polished chrome



ZCS
Cromo satinato
Satin chrome



ZNE
Nero
Black



ZAN
Antracite
Anthracite

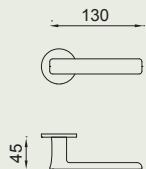

VIS FO12

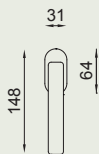

VIS FO22V

 FO22TS

fold 02

design:
Mario Padiglione

made in italy



FO14
ZAN

272-

dnd22-23

Zama
Zamak



ZC
Cromo lucido
Polished chrome



ZCS
Cromo satinato
Satin chrome



ZNE
Nero
Black



ZAN
Antracite
Anthracite

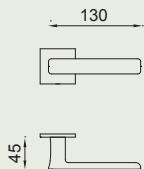

VIS FO14

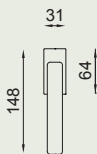

VIS FO25V

 FO25TS

joy

design:
Nicola Novelletto

made in italy



JO12
ZNE

274-

dnd22-23

Zama
Zamak



ZC
Cromo lucido
Polished chrome



ZCS
Cromo satinato
Satin chrome



ZNS
Nickel satinato
Satin nickel



ZNE
Nero
Black



ZAN
Antracite
Anthracite

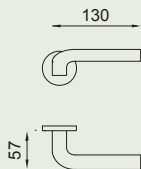

VIS JO12



VIS JO22V

 JO22TS

joy 02

design:
Nicola Novelletto

made in italy



JO14
ZOS

276-

dnd22-23

Zama
Zamak



ZC
Cromo lucido
Polished chrome



ZCS
Cromo satinato
Satin chrome



ZNS
Nickel satinato
Satin nickel



ZNE
Nero
Black



ZAN
Antracite
Anthracite

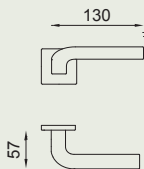

VIS JO14



VIS JO25V

 JO25TS

sochic

**design: Dnd
technical division**

made in italy



SC14
ZNE

278-

dnd22-23

Zama
Zamak



ZC
Cromo lucido
Polished chrome



ZOR
Placcato oro 24 k
Gold plated 24 k



ZNE
Nero
Black



sochic 02 - ZC
Cromo lucido
Polished chrome



sochic 02 - ZOR
Placcato oro 24 k
Gold plated 24 k



sochic 02 - ZNE
Nero
Black

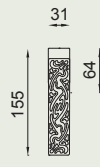
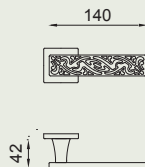
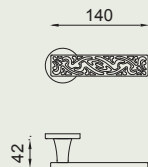

VIS SC12

U SC80

U SC22TS

VIS SC22V

U SC22U

VIS SC14

VIS SC25V

U SC25TS

sochic L

design: Dnd
technical division

made in italy

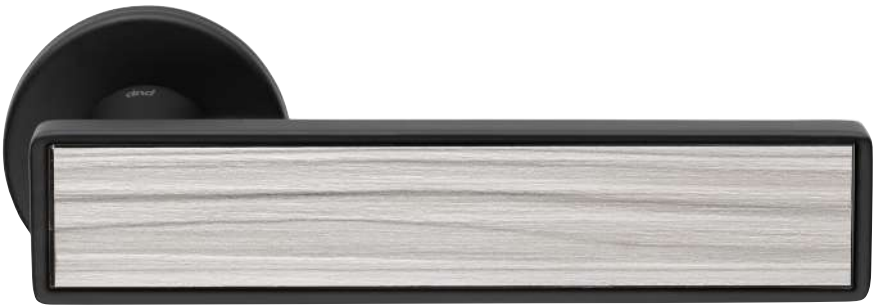

SL12
NLS

280-

dnd22-23

Zama
Zamak



NLS

Nero + inserto
larice sabbia
Black + sand
Larchwood insert



NPB

Nero + inserto
palissandro bianco
Black + white
Rosewood insert



sochic L 02 - SPL

Cromo satinato
+ inserto palissandro scuro
Satin chrome
+ dark Rosewood insert



sochic L 02 - SRT

Cromo satinato
+ inserto rovere tanché
Satin chrome
+ tanché Oakwood insert

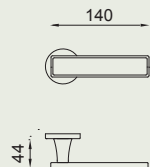

VIS SL12

FINE SL40

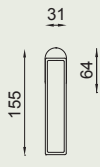

VIS SL22V

LOCK SL22TS

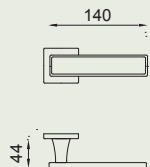

VIS SL14

FINE SL41

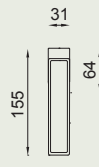

VIS SL25V

LOCK SL25TS

art

design:
Mauro Ronchi

made in italy



AR40
OC

282-

dnd22-23

Ottone stampato a caldo
Hot stamped brass



OGH
Bronzo satinato opaco
Matt satin bronze



OC
Power cromo lucido
Power polished chrome

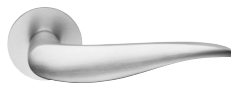

PCS
Power cromo satinato
Power satin chrome



ONS
Nickel satinato
Satin nickel



PVD | forte®
Ottone lucido
Polished brass

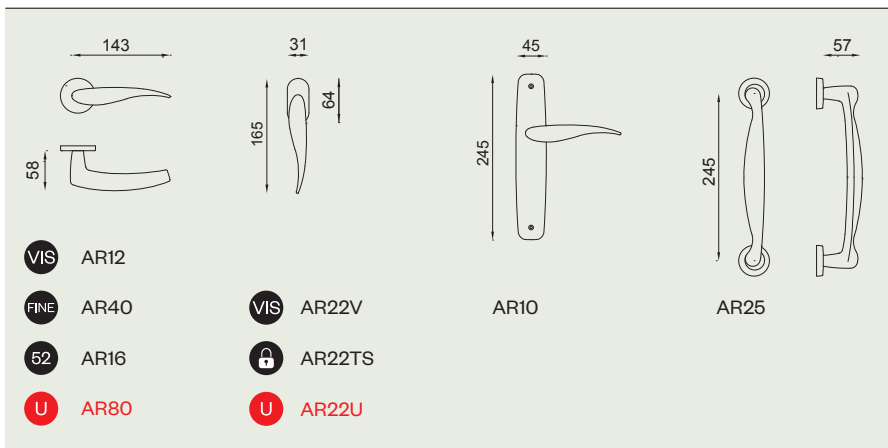

linear

design:
Mauro Ronchi

made in italy



LI40
PVD-SG | forte®

284-

dnd22-23

Ottone stampato a caldo
Hot stamped brass



OGH
Bronzo satinato opaco
Matt satin bronze



OC
Power cromo lucido
Power polished chrome



PCS
Power cromo satinato
Power satin chrome



PVD-BG | forte®
Oro antico lucido
Antique bright gold



PVD-SG | forte®
Oro antico satinato
Antique satin gold

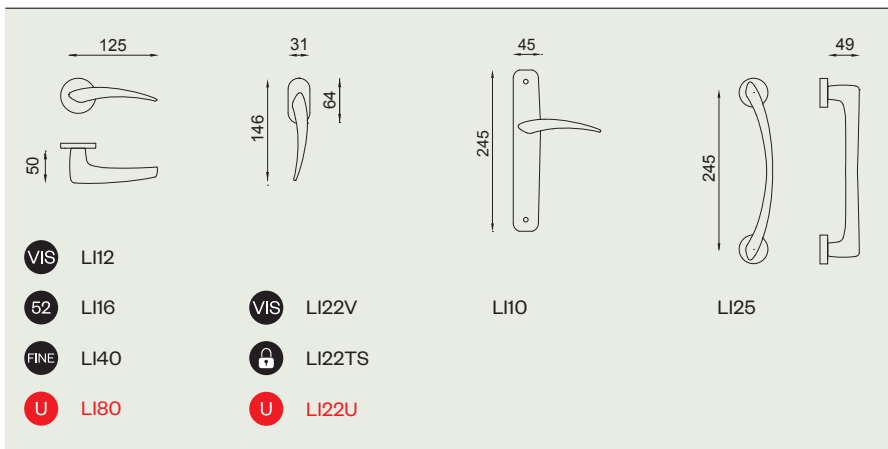

dolce

design:
Mauro Ronchi

made in italy



DO40
OGH

286-

dnd22-23

Ottone stampato a caldo
Hot stamped brass



OGH
Bronzo satinato opaco
Matt satin bronze



OC
Power cromo lucido
Power polished chrome



PCS
Power cromo satinato
Power satin chrome



ONS
Nickel satinato
Satin nickel

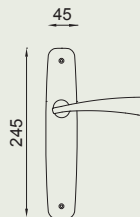
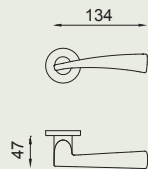

VIS DO12

FINE DO40

52 DO16

VIS DO22V

🔒 DO22TS

DO10

blip

design:
Karim Rashid

made in italy



BL16
OC

288-

dnd/22-23

Ottone
Solid brass



OC
Power cromo lucido
Power polished chrome



PCS
Power cromo satinato
Power satin chrome



ONO
Nero
Black

145



64



VIS BL12

52 BL16

twist

design:
Karim Rashid

made in italy



TW14
OC

290-

dnd22-23

Ottone stampato a caldo
Hot stamped brass



OC
Power cromo lucido
Power polished chrome



PCS
Power cromo satinato
Power satin chrome



ONS
Nickel satinato
Satin nickel



twist 02 - OC
Power cromo lucido
Power polished chrome



twist 02 - PCS
Power cromo satinato
Power satin chrome



twist 02 - ONS
Nickel satinato
Satin nickel

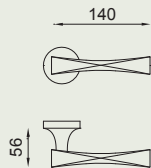

VIS TW12

R TW14

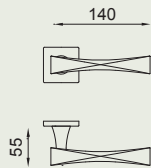

VIS TW13

52 TW18

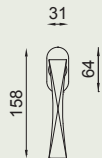

VIS TW22V

🔒 TW22TS

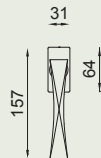

VIS TW25V

🔒 TW25TS

sike

design:
Karim Rashid

made in italy



SK14
OC

292-

dnd/22-23

Ottone stampato a caldo
Hot stamped brass



OGH

Bronzo satinato opaco
Matt satin bronze



OC

Power cromo lucido
Power polished chrome



PCS

Power cromo satinato
Power satin chrome



sike 02 - OGH

Bronzo satinato opaco
Matt satin bronze



sike 02 - OC

Power cromo lucido
Power polished chrome



sike 02 - PCS

Power cromo satinato
Power satin chrome



Good Design Awards
2006

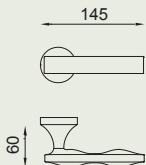

VIS SK12

R SK14

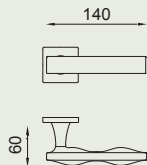

VIS SK13

52 SK18

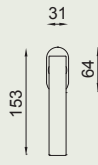

VIS SK22V

LOCK SK22TS

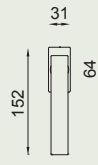

R SK25

LOCK SK25TS

project

design: Dnd
technical division

made in italy



PR12
OS

294-

dnd22-23

Ottone stampato a caldo
Hot stamped brass



OLV
Lucido
Polished



OS
Satinato
Satin



AB
Bronzato
Antique bronze



OC
Power cromo lucido
Power polished chrome



PCS
Power cromo satinato
Power satin chrome



ONS
Nickel satinato
Satin nickel



ONO
Nero
Black



V702
Marrone scuro
Dark brown

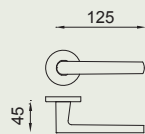

VIS PR12

52 PR16

FINE PR40

S PR62

U PR80

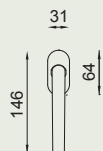

VIS PR22V

S PR22TS

U PR22U



PR35

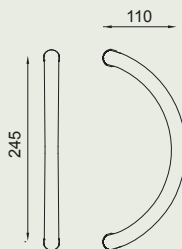

PR27 - singolo

PR29 - singolo

PR26 - set

PR28 - set

project 02

design: Dnd
technical division

made in italy

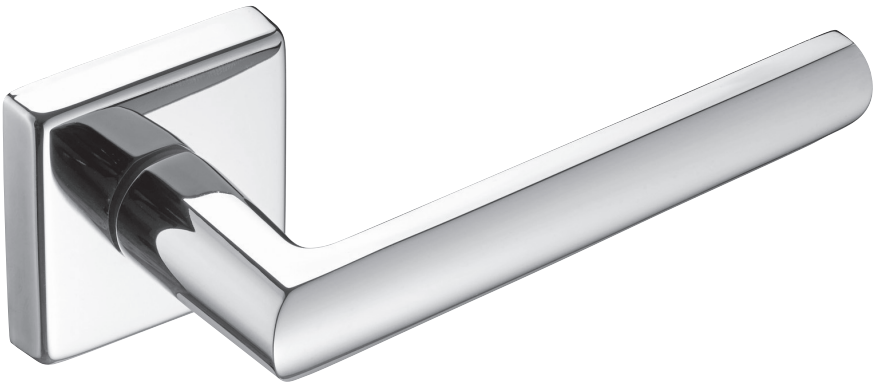

PR14
OC

296-

dnd22-23

Ottone stampato a caldo
Hot stamped brass



AB
Bronzato
Antique bronze



OC
Power cromo lucido
Power polished chrome



PCS
Power cromo satinato
Power satin chrome



ONS
Nickel satinato
Satin nickel



ONO
Nero
Black



V702
Marrone scuro
Dark brown

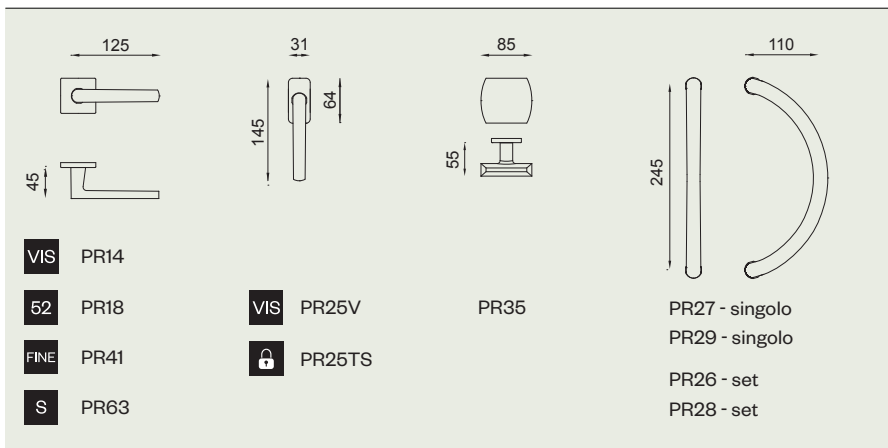

project zancata

design: Dnd
technical division

made in italy



PO12
OC

298-

dnd/22-23

Ottone
Solid brass



OC
Power cromolo lucido
Power polished chrome



PCS
Power cromolo satinato
Power satin chrome



ONS
Nickel satinato
Satin nickel



PVD | forte®
Ottone lucido
Polished brass



project z. 02 - OC
Power cromolo lucido
Power polished chrome



project z. 02 - PCS
Power cromolo satinato
Power satin chrome



project z. 02 - ONS
Nickel satinato
Satin nickel



**project z. 02
PVD | forte®**
Ottone lucido
Polished brass

94



94



55



55



VIS PO12

52 PO16

VIS PO14

52 PO18

havana

design:
Studio Hot Lab

made in italy



HV12
PVD-BG | forte®+VE

300-

dnd22-23

Ottone stampato a caldo e pelle di prima qualità "pieno fiore"
Hot stamped brass and high quality leather



OLV + PA
 Ottone lucido + Papaya
Polished brass + Papaya



OC + NA
 Power cromo lucido + Navy
Power polished chrome + Navy



PCS + PA
 Power cromo satinato + Papaya
Power satin chrome + Papaya



PCS + NA
 Power cromo satinato + Navy
Power satin chrome + Navy



PVD-BG | forte® + VE new
 Oro antico lucido + Verde
Antique bright gold + Green



PVD-SG | forte® + VE new
 Oro antico satinato + Verde
Antique satin gold + Green

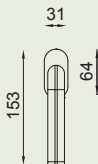
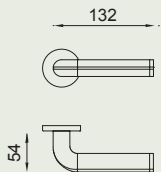

VIS HV12

FINE HV40

VIS HV22V

🔒 HV22TS

vita

design:
Mauro Ronchi

made in italy



VI12
PVD | forte®

302-

dnd22-23

Ottone stampato a caldo
Hot stamped brass



OC
Power cromo lucido
Power polished chrome



PCS
Power cromo satinato
Power satin chrome



ONS
Nickel satinato
Satin nickel



PGS | forte®
Grafite satinato
Satin graphite



PVD | forte®
Ottone lucido
Polished brass



PVX | forte®
Inox satinato
Satin steel

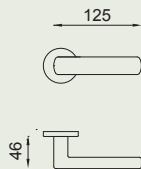

VIS VI12

62 VI16

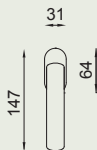

VIS VI22V

🔒 VI22TS

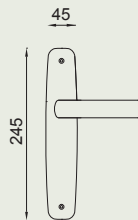

VI10

vita 02

design:
Mauro Ronchi

made in italy



v118
OC

304-

dnd22-23

Ottone stampato a caldo
Hot stamped brass



OC
Power cromo lucido
Power polished chrome



PCS
Power cromo satinato
Power satin chrome



ONS
Nickel satinato
Satin nickel



PGS | forte®
Grafite satinato
Satin graphite



PVX | forte®
Inox satinato
Satin steel

Fino esaurimento scorte (rosetta 52)

While still in stock (52 rose)

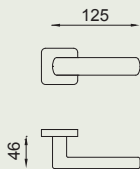

VIS VI14

VIS VI25V

52 VI18

 VI25TS

fluò

design:
Mauro Ronchi

made in italy



FL16
OLV

306-

dnd22-23

Ottone stampato a caldo
Hot stamped brass



OLV
Lucido
Polished



OC
Power cromo lucido
Power polished chrome



PCS
Power cromo satinato
Power satin chrome

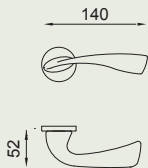

VIS FL12

52 FL16



VIS FL22V

🔒 FL22TS

go

design:
Mauro Ronchi

made in italy



GO16
OC

308-

dnd22-23

Ottone stampato a caldo
Hot stamped brass



OC
Power cromo lucido
Power polished chrome



PCS
Power cromo satinato
Power satin chrome

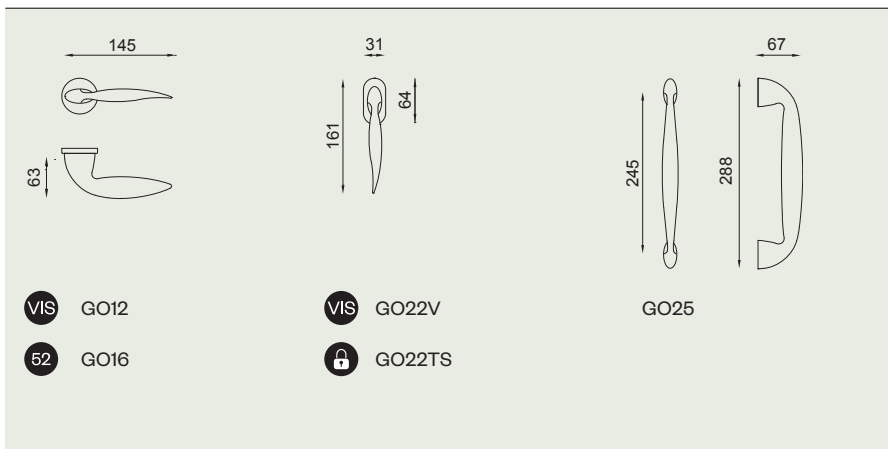

mix

design: Dnd
technical division

made in italy



M112
OC+R

310-

dnd22-23

Ottone, zama e acciaio
Brass, zamak and stainless steel



OC + R

Cromo lucido + rete
Polished chrome + screen



OCS + R

Cromo satinato + rete
Satin chrome + screen



CNE

Cromo lucido - nero
Polished chrome - black



CSNE

Cromo satinato - nero
Satin chrome - black

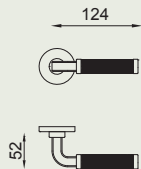

VIS MI12

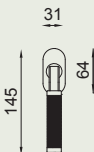

VIS MI22V

 MI22TS

stick 02

design:
Novelletto - Greco

made in italy

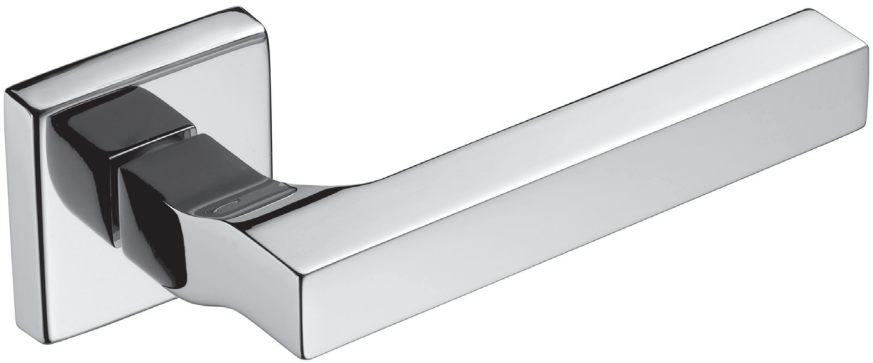

861/14
ZC

312-

dnd/22-23

Zama
Zamak



ZC
Cromo lucido
Polished chrome



ZCS
Cromo satinato
Satin chrome

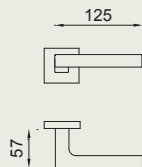

VIS 861/14

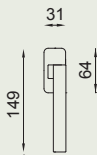

VIS 866V

 866TS

quattro 02 Z

Zama / Zamak

design: Dnd
technical division

made in italy



VIS 264/14-Z
ZC



link

Ottone stampato a caldo / Hot stamped brass

design:
Mauro Ronchi

made in italy



VIS 653/12
OC



nova

Ottone stampato a caldo / Hot stamped brass

design:
Mauro Ronchi

made in italy



VIS 663/12
OCS



tipo

Zama / Zamak

design:
Pietro Silva

made in italy



VIS 172/12-Z
ZC

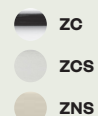

S40

Acciaio inox AISI 316 / *Stainless steel AISI 316*

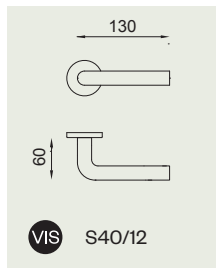

S50

Acciaio inox AISI 316 / *Stainless steel AISI 316*

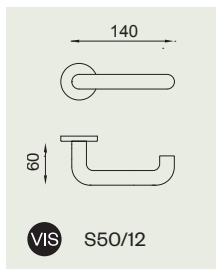

S60

Acciaio inox AISI 316 / *Stainless steel AISI 316*

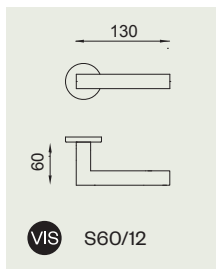

maniglie

– classic
handles

classic

fiorenza

design: Dnd
technical division

made in italy



519
ORO

318-

dnd/22-23

Ottone stampato a caldo
Hot stamped brass



OGH
Bronzo satinato opaco
Matt satin bronze



ONV
Nickel lucido
Polished nickel



OROF
Oro francese antico
French antique gold



ORO
Placcato oro 24k
Gold plated 24k



VIS 523/12

R 523



VIS 521V

🔒 521TS

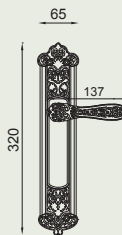

519

fiore

design: Dnd
technical division

made in italy



525
OGH

320-

dnd/22-23

Ottone stampato a caldo
Hot stamped brass



OGH
Bronzo satinato opaco
Matt satin bronze



ONV
Nickel lucido
Polished nickel



OROF
Oro francese antico
French antique gold



ORO
Placcato oro 24k
Gold plated 24k

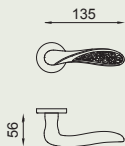

VIS 522/12

R 522



VIS 526V

🔒 526TS

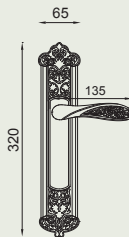

525

fedora

**design: Dnd
technical division**

made in italy



530/12
AB

322-

dnd22-23

Ottone stampato a caldo
Hot stamped brass



AB
Bronzato
Antique bronze



OGH
Bronzo satinato opaco
Matt satin bronze



PCS
Power cromo satinato
Power satin chrome



PVD-BG | forte®
Oro antico lucido
Antique bright gold



PVD-SG | forte®
Oro antico satinato
Antique satin gold

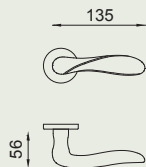

VIS 530/12

R 528

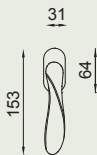

VIS 529V

🔒 529/TS

lirica

design: Dnd
technical division

made in italy



806/12
ONV

324-

dnd22-23

Ottone
Solid brass



OLV
Lucido
Polished



AF
Anticato
Antique finish



BSS
Bronzo scuro sfumato
Shaded dark bronze



OCS
Cromo satinato
Satin chrome



ONV
Nickel lucido
Polished nickel



FAN
Ferro anticato
Antique iron

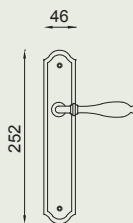
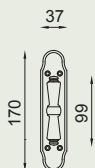
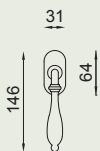
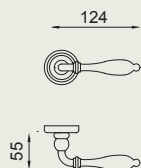

- VIS** 806/12
- B** 801/B
- V** 803

- VIS** 805V
- 🔒** 805TS

- 394
- 395

- 800

classic

design: Dnd
technical division

made in italy



571/12
OLV

326-

dnd22-23

Ottone
Solid brass



OLV
Lucido
Polished



OS
Satinato
Satin



AB
Bronzato
Antique bronze



OGH
Bronzo satinato opaco
Matt satin bronze

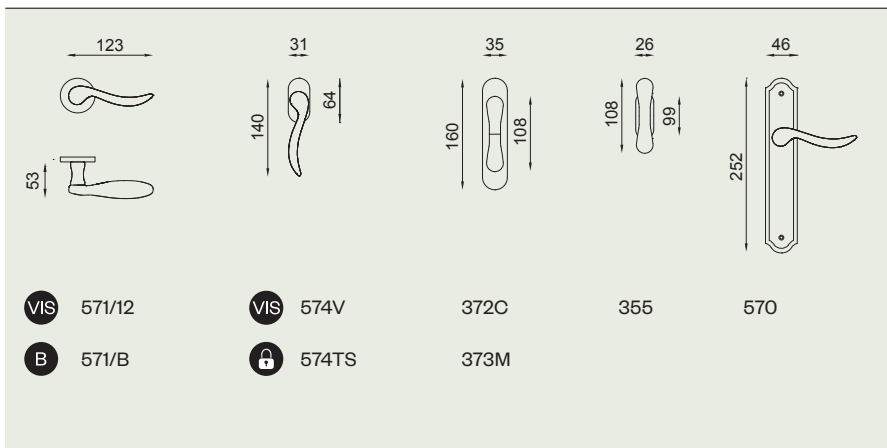

ardea

design:
Mauro Ronchi

made in italy



AD12
OLV

328-

dnd22-23

Ottone stampato a caldo
Hot stamped brass



OLV
Lucido
Polished



OGH
Bronzo satinato opaco
Matt satin bronze



ONV
Nickel lucido
Polished nickel



OLV
Lucido
Polished



ONV
Nickel lucido
Polished nickel



VIS AD12

R AD13

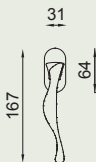

VIS AD22V

🔒 AD22TS

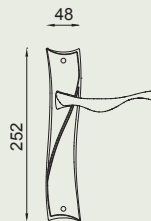

AD10

cassia

design:
Mauro Ronchi

made in italy



CA13
OLV

330-

dnd22-23

Ottone stampato a caldo
Hot stamped brass



OLV
Lucido
Polished



OGH
Bronzo satinato opaco
Matt satin bronze

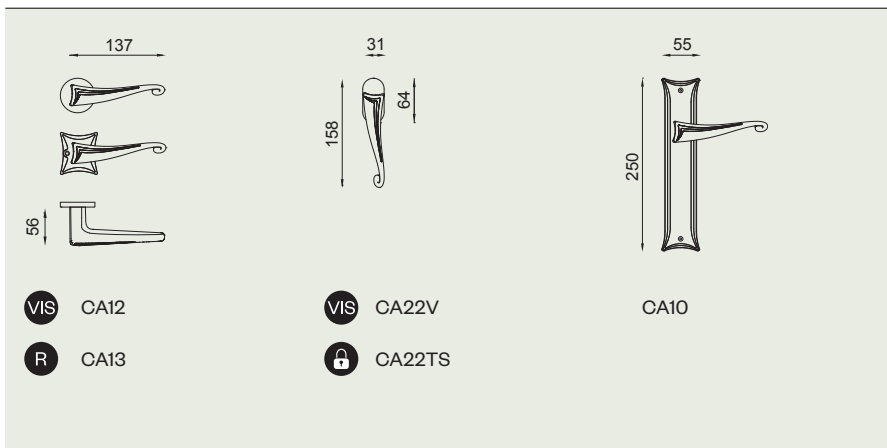

beverly

design:
Mauro Ronchi

made in italy



141/12
OLV

332-

dnd/22-23

Ottone stampato a caldo
Hot stamped brass



OLV
Lucido
Polished



OGH
Bronzo satinato opaco
Matt satin bronze

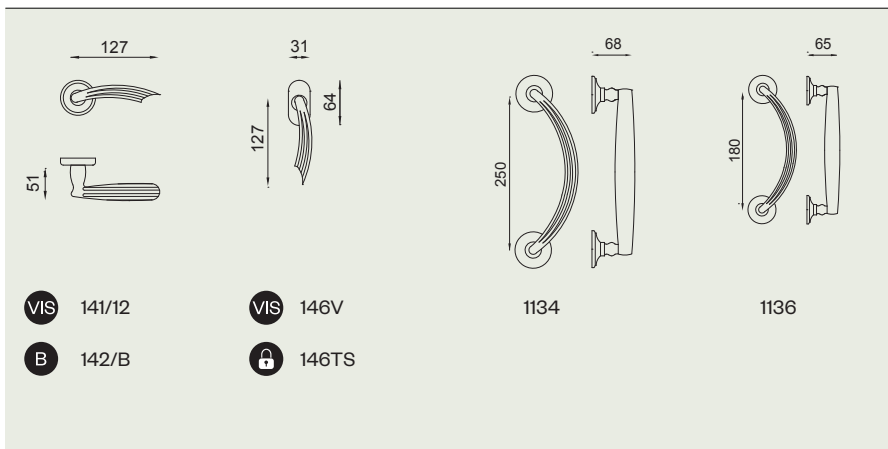

latina

design:
Mauro Ronchi

made in italy



823/12
OLV

334-

dnd22-23

Ottone stampato a caldo
Hot stamped brass



OLV
Lucido
Polished



OGH
Bronzo satinato opaco
Matt satin bronze



BSS
Bronzo scuro sfumato
Shaded dark bronze



VIS 823/12

R 824



VIS 829V

🔒 829TS

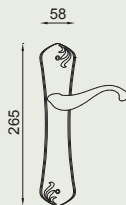

820



110

lady

**design: Dnd
technical division**

made in italy



568/B
OLV

336-

dnd22-23

Ottone stampato a caldo
Hot stamped brass



OLV
Lucido
Polished



OGH
Bronzo satinato opaco
Matt satin bronze



BSS
Bronzo scuro sfumato
Shaded dark bronze



OC
Cromo lucido
Polished chrome



OCS
Cromo satinato
Satin chrome



VIS 568/12

B 568/B



VIS 565V

🔒 565TS

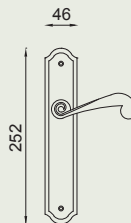

567

appia

design:
Mauro Ronchi

made in italy



833/12
BSS

338-

dnd22-23

Ottone stampato a caldo
Hot stamped brass



OLV
Lucido
Polished



OGH
Bronzo satinato opaco
Matt satin bronze



BSS
Bronzo scuro sfumato
Shaded dark bronze



VIS 833/12

R 834



VIS 839V

🔒 839TS

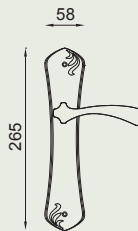

830

airone

Ottone / Solid brass

design:
Mauro Ronchi

made in italy



VIS 603/12
OLV

- OLV
- OGC
- OS
- OC
- OCS

beauty

Ottone / Solid brass

design: **Dnd**
technical division

made in italy



VIS 775/B
OLV

- OLV
- OGH
- AF
- OCS
- FAN

bruxelles

Ottone / Solid brass

design: **Dnd**
technical division

made in italy



VIS 362/12
FAN

- OLV
- OGH
- AF
- OCS
- FAN

daniela

Ottone / Solid brass



vis 391/12
OLV

design: Dnd
technical division

made in italy

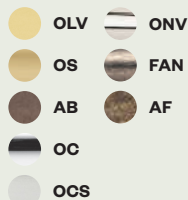

daniela porcellana

Ottone / Solid brass



vis 391/12
ONV + P1

design: Dnd
technical division

made in italy



P1= porcellana bianca /
white porcelain
P6= porcellana avorio /
ivory porcelain

lorena

Ottone / Solid brass



vis 251/12
OLV

design: Dnd
technical division

made in italy



combinazioni particolari

—

combinations

Kit hotel maniglia-pomolo / *Knob-handle hotel kit*



**Principali soluzioni /
Main solutions**

Maniglia / handle
Pomolo / knob

**ARETÈ L 02
RING**

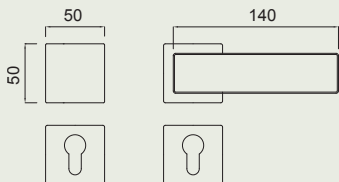

Maniglia / handle
Pomolo / knob

**CHANGE B 02
RING**

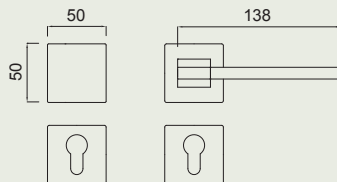

Maniglia / handle
Pomolo / knob

**EDRA 02
RING**

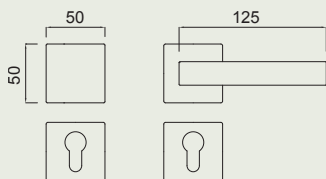

Maniglia / handle
Pomolo / knob

**LUXURY 02
RING**

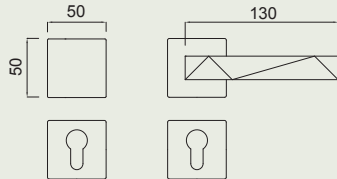

Maniglia / handle
Pomolo / knob

**QUATTRO 02
QUADRO**

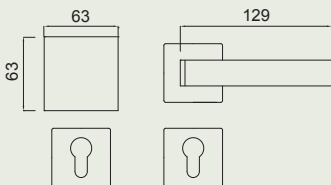

Kit hotel maniglia-pomolo / *Knob-handle hotel kit*

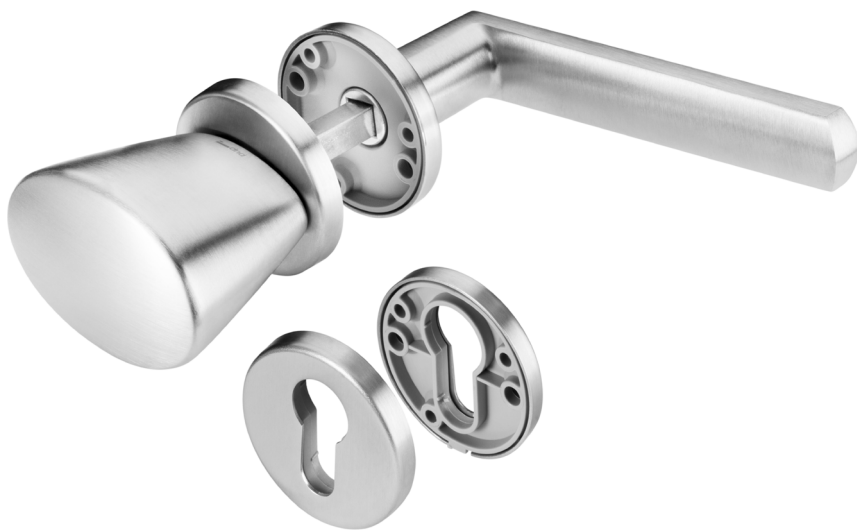

**Principali soluzioni /
Main solutions**

Maniglia / handle
Pomolo / knob

TIMELESS
TIMELESS

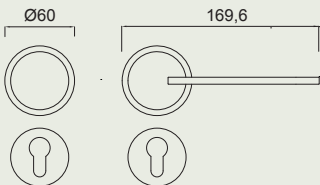

Maniglia / handle
Pomolo / knob

LUCE
RONDÒ

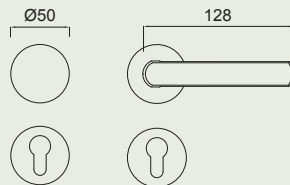

Maniglia / handle
Pomolo / knob

CHOP
RONDÒ

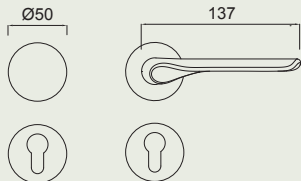

Maniglia / handle
Pomolo / knob

SAFETY
RONDÒ

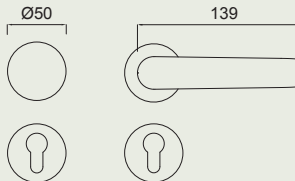

Maniglia / handle
Pomolo / knob

SHORT
RONDÒ

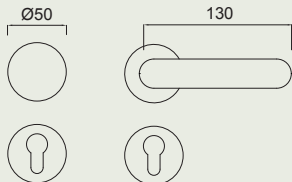

Maniglia / handle
Pomolo / knob

ART
RONDÒ

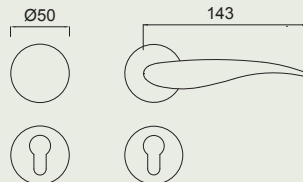

maniglie

– windows

per finestre

handles

Per tutti i modelli di maniglie è disponibile il sistema per finestra (dk).
A seguire alcuni esempi.

*Window handles (dk) are available for all our door handle models.
In the following pages some examples.*

aretè

Ottone forgiato
Forged brass



design:
Mauro Ronchi

made in italy

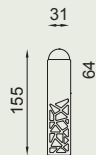

- AB
- OGH
- OC
- PCS
- PGS | forte®
- PVX | forte®
- PVD-SG | forte®

VIS AT22V

AT22TS

aretè 02

Ottone forgiato
Forged brass



design:
Mauro Ronchi

made in italy

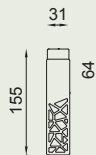

- AB
- OGH
- OC
- PCS
- PGS | forte®
- PVX | forte®
- PVD-SG | forte®

AT25

VIS AT25V

AT25TS

C-1918

Acciaio inox AISI 316 + rame
AISI Stainless steel 316 + copper



design:
Achille Castiglioni
Gianfranco Cavaglia

made in italy

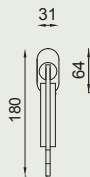

-  S316 + R
-  L316 + R
-  S316 + N
-  L316 + N

CC22

cloe 02

Ottone stampato a caldo
Hot stamped brass



design: Dnd
technical division

made in italy

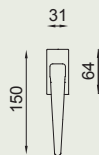

-  OC
-  PCS
-  PGS | forte®
-  PVD-BG | forte®
-  PVD-SG | forte®

 CL25V

 CL25TS

change B02

Ottone stampato a caldo
Hot stamped brass

design:
Sandro Santantonio

made in italy

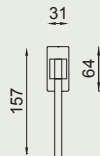

- CCS
- OBN
- ONO
- V702

- R CB25
- VIS CB25V
- CB25TS

edra 02

Ottone stampato a caldo
Hot stamped brass

design:
Mauro Ronchi

made in italy

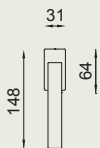

- OGH
- OC
- PCS
- ONO
- ONS
- PGS | forte®
- PVX | forte®
- PVD-SG | forte®
- PVD-SCB | forte®

- R ED25
- VIS ED25V
- ED25TS

esa due

Alluminio e zama
Aluminium and zamak

design: Dnd
technical division

made in italy

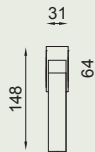

VIS EU25V

LOCK EU25TS

fluke

Ottone stampato a caldo
Hot stamped brass

design:
Karim Rashid

made in italy

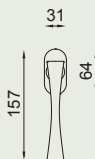

VIS FK22V

LOCK FK22TS

luxury 02

Ottone stampato a caldo
Hot stamped brass

design:
Mauro Ronchi

made in italy

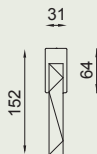

R LU25
VIS LU25V
🔒 LU25TS



ginkgo

Ottone stampato a caldo
Hot stamped brass

design:
Giulio Iacchetti

made in italy

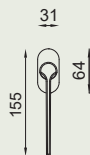

VIS GK22V
🔒 GK22TS



ginkgo biloba

Ottone stampato a caldo
Hot stamped brass

design:
Giulio Iacchetti

made in italy

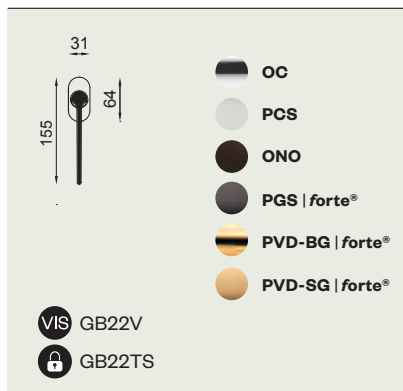

isabella

Ottone stampato a caldo
Hot stamped brass

design:
Marco Pisati

made in italy

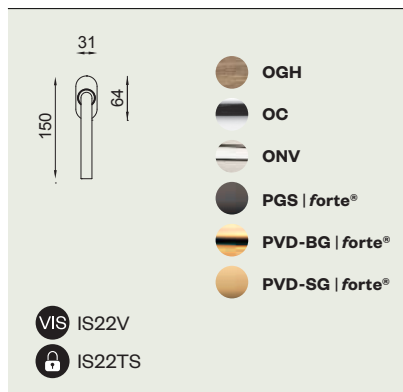

lucrezia

Ottone stampato a caldo
Hot stamped brass

design:
Marco Pisati

made in italy

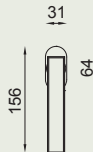

- OGH
- ONV
- PGS | forte®
- PVD-BG | forte®
- PVD-SG | forte®

VIS LT30V

LT30TS

luce

Zama
Zamak

design: Dnd
technical division

made in italy

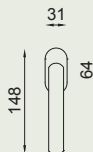

- ZGH
- ZC
- ZCS
- ZNS
- ZNE
- ZAN

VIS LC30V

LC30TS

luce 02

Zama
Zamak

design: Dnd
technical division

made in italy

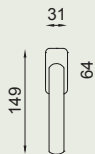

- ZGH
- ZC
- ZCS
- ZNS
- ZNE
- ZAN

VIS LC31V
LOCK LC31TS

short

Ottone stampato a caldo
Hot stamped brass

design:
Karim Rashid

made in italy

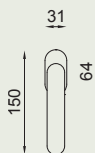

- AB
- OC
- PCS
- ONO
- PGS | forte®
- PVD-SG | forte®
- PVD-SCB | forte®

VIS SH22V
LOCK SH22TS

maniglioni

—

pull handles

pod

NEW

Ottone stampato a caldo
Hot stamped brass

design:
Holscher Design

made in italy



OLV
Lucido
Polished



OC
Power cromo lucido
Power polished chrome



PCS
Power cromo satinato
Power satin chrome



ONO
Nero
Black



PVD-BG | forte®
Oro antico lucido
Antique bright gold



PVD-SG | forte®
Oro antico satinato
Antique satin gold



PGS | forte®
Grafite satinato
Satin graphite

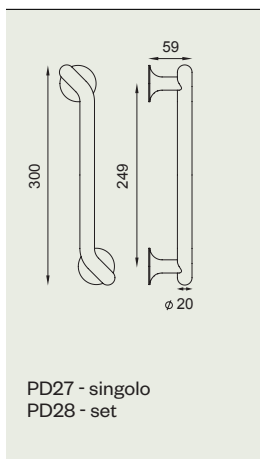
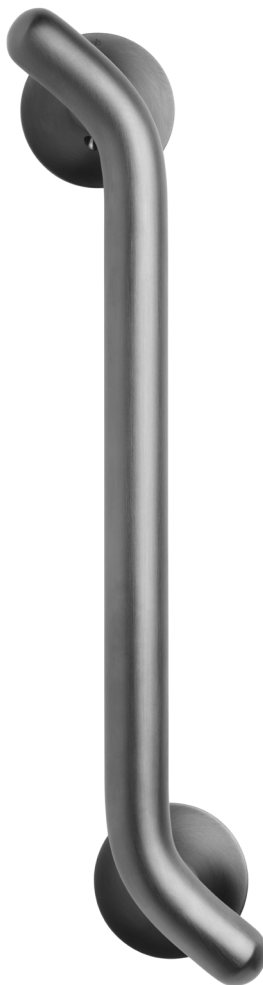

360-

dnd22-23

zeppelin

NEW

design:
Jaime Hayon

Ottone forgiato
Forged brass

made in italy



ONV
Nickel lucido
Polished nickel



OVE
Verde
Green



ONO
Nero
Black



PVD-BG | forte®
Oro antico lucido
Antique bright gold



PVD-SG | forte®
Oro antico satinato
Antique satin gold



PVD-SCB | forte®
Rame satinato
Satin copper



PGS | forte®
Grafite satinato
Satin graphite

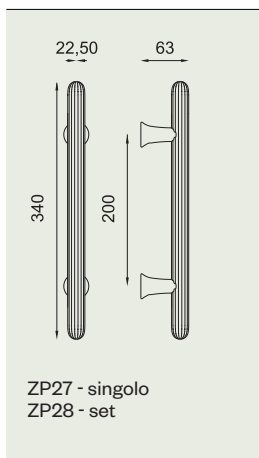

(IN)finito

NEW

design:
Alfonso Femia

Ottone
Solid brass

made in italy



OLV
Lucido
Polished



AB
Bronzato
Antique bronze



SO
Sabbato opaco
Matt sandblasted



PCS
Power cromo satinato
Power satin chrome



ONO
Nero
Black

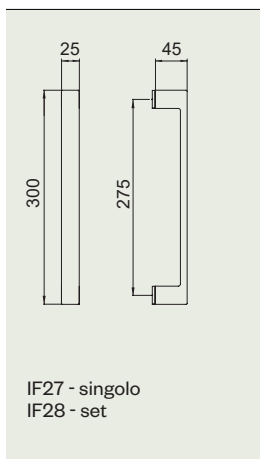

362-

dnd/22-23

(IN)finito NEW

Ottone
Solid brass

design:
Alfonso Femia

made in italy



OLV
Lucido
Polished



AB
Bronzato
Antique bronze



SO
Sabbiato opaco
Matt sandblasted



PCS
Power cromo satinato
Power satin chrome



ONO
Nero
Black

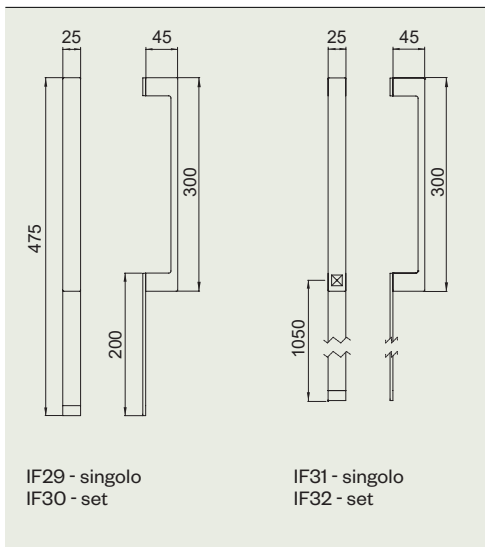

eleonora

NEW

design:
Marco Pisati

Ottone forgiato
Forged brass

made in italy



OGH
Bronzo satinato opaco
Matt satin bronze



ONV
Nickel lucido
Polished nickel



PVD-BG | forte®
Oro antico lucido
Antique bright gold



PVD-SG | forte®
Oro antico satinato
Antique satin gold



PGS | forte®
Grafite satinato
Satin graphite

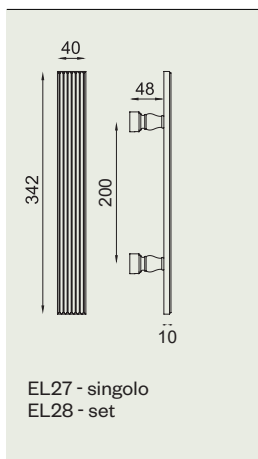

364-

dnd22-23

eleonora NEW

Ottone forgiato
Forged brass

design:
Marco Pisati

made in italy



OGH

Bronzo satinato opaco
Matt satin bronze



ONV

Nickel lucido
Polished nickel



PVD-BG | forte®

Oro antico lucido
Antique bright gold



PVD-SG | forte®

Oro antico satinato
Antique satin gold



PGS | forte®

Grafite satinato
Satin graphite

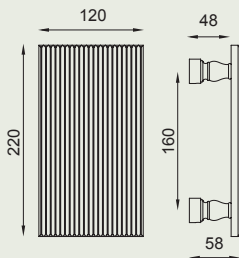
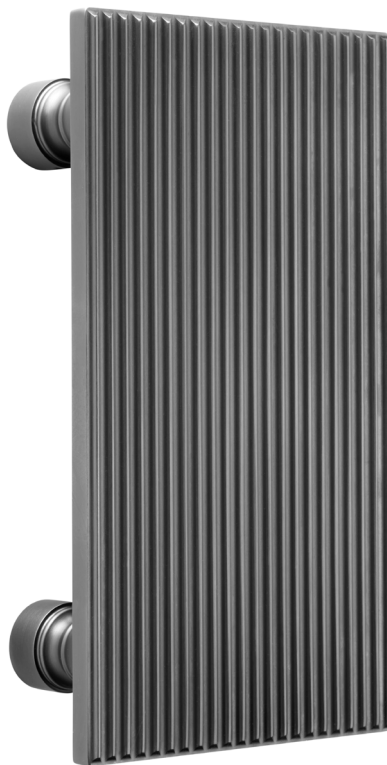

EL29 - singolo
EL30 - set

ginkgo

Ottone forgiato
Forged brass

design:
Giulio lacchetti

made in italy

PCS
Power cromo satinato
Power satin chrome

ONV
Nickel lucido
Polished nickel

ONO
Nero
Black

PGS | forte®
Grafite satinato
Satin graphite

PVD-BG | forte®
Oro antico lucido
Antique bright gold

PVD-SG | forte®
Oro antico satinato
Antique satin gold

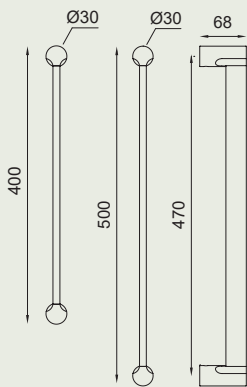

* GK27 - singolo (400 mm)

* GK28 - set (400 mm)

* GK29 - singolo (500 mm)

* GK30 - set (500 mm)

* Altre misure disponibili
su richiesta.
*Other lengths available
on request.*

ginkgo biloba

design:
Giulio lacchetti

Ottone forgiato
Forged brass

made in italy

 **PCS**
Power cromo satinato
Power satin chrome

 **ONV**
Nickel lucido
Polished nickel

 **ONO**
Nero
Black

 **PGS | forte®**
Grafite satinato
Satin graphite

 **PVD-BG | forte®**
Oro antico lucido
Antique bright gold

 **PVD-SG | forte®**
Oro antico satinato
Antique satin gold

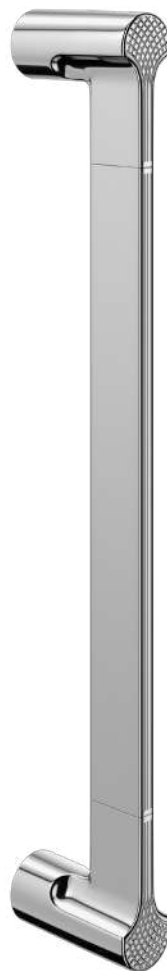
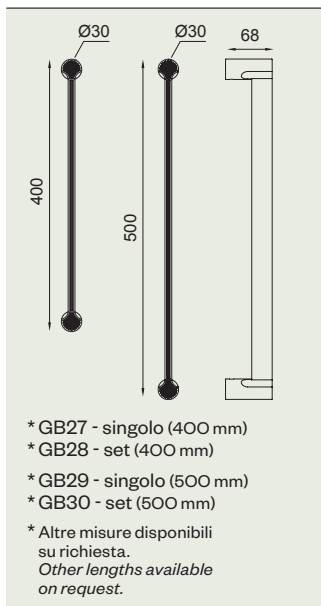

lucrezia

Ottone forgiato
Forged brass

design:
Marco Pisati

made in italy



OGH
Bronzo satinato opaco
Matt satin bronze



ONV
Nickel lucido
Polished nickel



PGS | forte®
Grafite satinato
Satin graphite



PVD-BG | forte®
Oro antico lucido
Antique bright gold



PVD-SG | forte®
Oro antico satinato
Antique satin gold

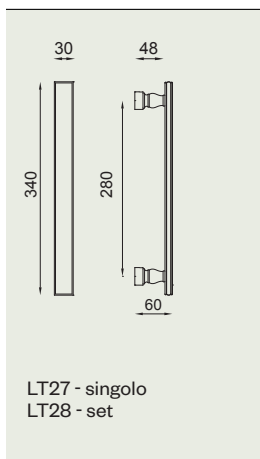

368-

dnd22-23

luxury

design:
Mauro Ronchi

Ottone stampato a caldo
Hot stamped brass

made in italy



OGH

Bronzo satinato opaco
Matt satin bronze



OC

Power cromo lucido
Power polished chrome



PCS

Power cromo satinato
Power satin chrome



ONO

Nero
Black



PGS | forte®

Grafite satinato
Satin graphite



PVD-BG | forte®

Oro antico lucido
Antique bright gold



PVD-SG | forte®

Oro antico satinato
Antique satin gold



PVD-SCB | forte®

Rame satinato
Satin copper

25

40



300



LU27 - singolo
LU28 - set



aretè

Ottone forgiato
Forged brass

design:
Mauro Ronchi

made in italy



AB
Bronzato
Antique bronze



OGH
Bronzo satinato opaco
Matt satin bronze



OC
Power cromo lucido
Power polished chrome



PCS
Power cromo satinato
Power satin chrome



PGS | forte®
Grafite satinato
Satin graphite



PVX | forte®
Inox satinato
Satin steel



PVD-SG | forte®
Oro antico satinato
Antique satin gold

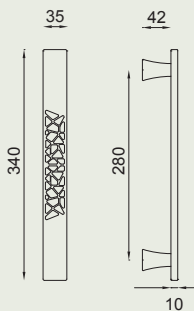

* AT27 - singolo

* AT28 - set

* Altre misure disponibili
su richiesta.
*Other lengths available
on request.*

aretè L

design:
Mauro Ronchi

Ottone forgiato
Forged brass

made in italy



AB
Bronzato
Antique bronze



OGH
Bronzo satinato opaco
Matt satin bronze



OC
Power cromo lucido
Power polished chrome



PCS
Power cromo satinato
Power satin chrome



PGS | forte®
Grafite satinato
Satin graphite



PVX | forte®
Inox satinato
Satin steel



PVD-SG | forte®
Oro antico satinato
Antique satin gold

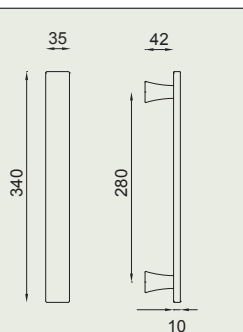

* AL27 - singolo

* AL28 - set

* Altre misure disponibili
su richiesta.
*Other lengths available
on request.*



C-1918

Acciaio inox AISI 316 + rame
AISI Stainless steel 316 + copper

design:
Achille Castiglioni
Gianfranco Cavaglia

made in italy



S316 + R

AISI 316 satinato
+ inserto rame PVD
AISI 316 satin
+ PVD copper insert



L316 + R

AISI 316 lucido
+ inserto rame PVD
AISI 316 polished
+ PVD copper insert



S316 + N

AISI 316 satinato
+ inserto rame nero
AISI 316 satin
+ black copper insert



L316 + N

AISI 316 lucido
+ inserto rame nero
AISI 316 polished
+ black copper insert

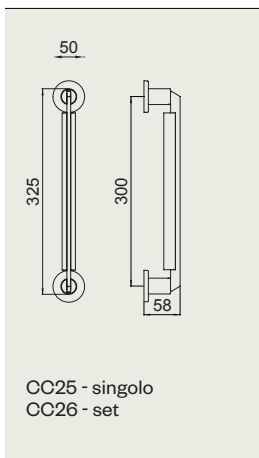

CC25 - singolo
CC26 - set

372-

dnd22-23

C-1918 zancato

design:
Achille Castiglioni
Gianfranco Cavaglia

Acciaio inox AISI 316 + rame
AISI Stainless steel 316 + copper

made in italy



S316 + R

AISI 316 satinato
+ inserto rame PVD
AISI 316 satin
+ PVD copper insert



L316 + R

AISI 316 lucido
+ inserto rame PVD
AISI 316 polished
+ PVD copper insert



S316 + N

AISI 316 satinato
+ inserto rame nero
AISI 316 satin
+ black copper insert



L316 + N

AISI 316 lucido
+ inserto rame nero
AISI 316 polished
+ black copper insert

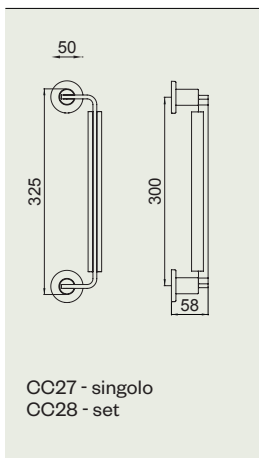

logo

Ottone stampato a caldo
Hot stamped brass

design:
Mauro Ronchi

made in italy



OC

Power cromo lucido
Power polished chrome



PCS

Power cromo satinato
Power satin chrome



ONS

Nickel satinato
Satin nickel



PVX | forte®

Inox satinato
Satin steel

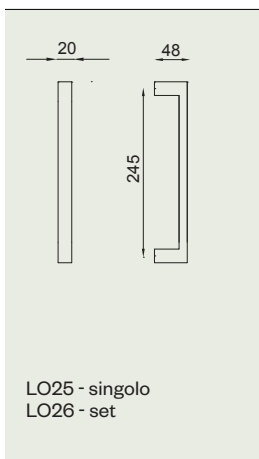

374-

dnd22-23

logo B

Ottone stampato a caldo
Hot stamped brass

design:
Mauro Ronchi

made in italy



CCS

Cromo - Power cromo satinato

Chrome - Power satin chrome

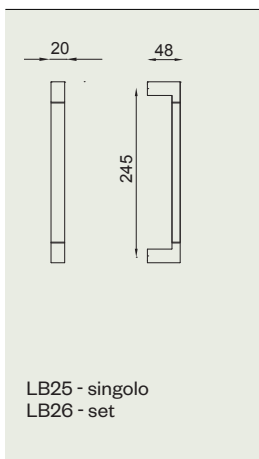

linear

Ottone stampato a caldo
Hot stamped brass

design:
Mauro Ronchi

made in italy



OGH

Bronzo satinato opaco
Matt satin bronze



OC

Power cromo lucido
Power polished chrome



PCS

Power cromo satinato
Power satin chrome



PVD-BG | forte®

Oro antico lucido
Antique bright gold



PVD-SG | forte®

Oro antico satinato
Antique satin gold

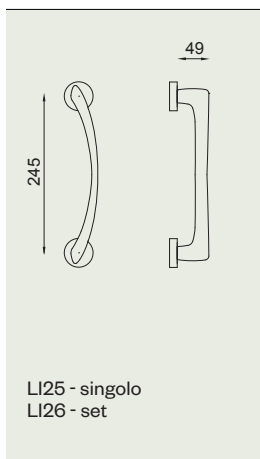

376-

dnd22-23

linear

Ottone stampato a caldo
Hot stamped brass

design:
Mauro Ronchi

made in italy



OGH

Bronzo satinato opaco
Matt satin bronze



OC

Power cromo lucido
Power polished chrome



PCS

Power cromo satinato
Power satin chrome



PVD-BG | forte®

Oro antico lucido
Antique bright gold



PVD-SG | forte®

Oro antico satinato
Antique satin gold

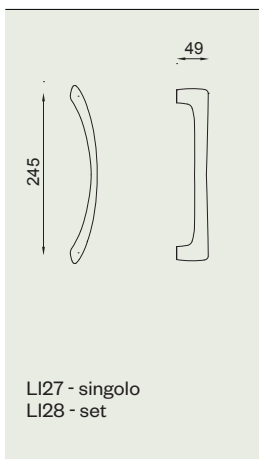

project

Ottone stampato a caldo
Hot stamped brass

design: Dnd
technical division

made in italy

-  **AB**
Bronzato
Antique bronze
-  **OC**
Power cromo lucido
Power polished chrome
-  **PCS**
Power cromo satinato
Power satin chrome
-  **ONS**
Nickel satinato
Satin nickel
-  **ONO**
Nero
Black

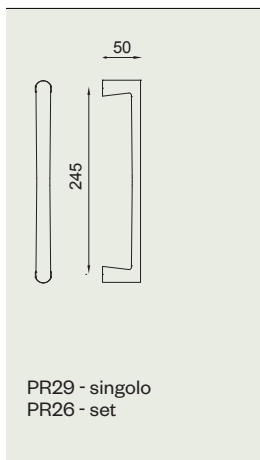

378-

dnd22-23

project spostato

design: Dnd
technical division

Ottone stampato a caldo
Hot stamped brass

made in italy

-  **AB**
Bronzato
Antique bronze
-  **OC**
Power cromo lucido
Power polished chrome
-  **PCS**
Power cromo satinato
Power satin chrome
-  **ONS**
Nickel satinato
Satin nickel
-  **ONO**
Nero
Black

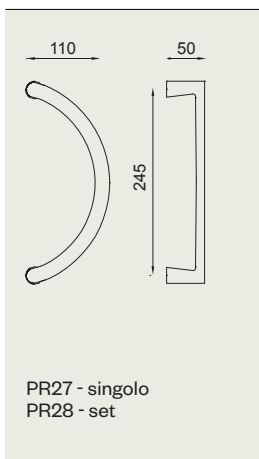

art

Ottone stampato a caldo
Hot stamped brass

design:
Mauro Ronchi

made in italy



OGH

Bronzo satinato opaco
Matt satin bronze



OC

Power cromo lucido
Power polished chrome



PCS

Power cromo satinato
Power satin chrome

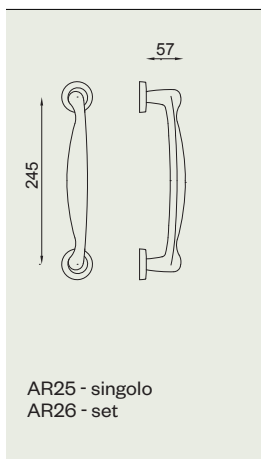

380-

dnd22-23

go

Ottone stampato a caldo
Hot stamped brass

design:
Mauro Ronchi

made in italy



OC
Power cromo lucido
Power polished chrome



PCS
Power cromo satinato
Power satin chrome

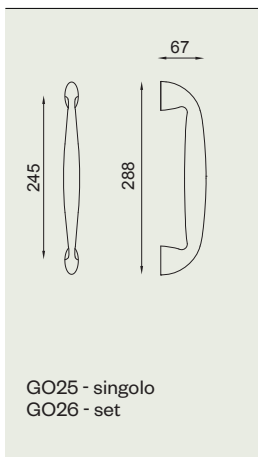

intake

Ottone forgiato
Forged brass

design:
Andrea Morgante

made in italy



OC

Power cromo lucido
Power polished chrome

**Altre finiture disponibili
su richiesta.**

*Other finishes available on
demand.*

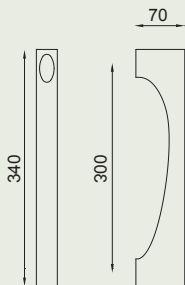

IN25 - singolo
IN26 - set



382-

dnd22-23

fluke

Ottone stampato a caldo
Hot stamped brass

design:
Karim Rashid

made in italy



OC
Power cromo lucido
Power polished chrome



PCS
Power cromo satinato
Power satin chrome

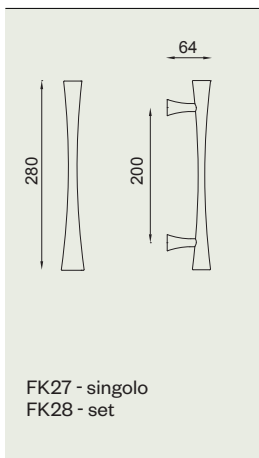

domus

Ottone
Brass

design: Dnd
technical division

made in italy



OLV
Lucido
Polished



OGH
Bronzo satinato opaco
Matt satin bronze



PCS
Power cromo satinato
Power satin chrome

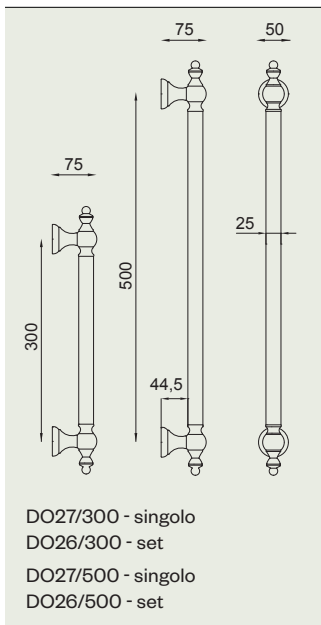

cloe

Ottone forgiato
Forged brass

**design: Dnd
technical division**

made in italy



OC
Power cromo lucido
Power polished chrome



PCS
Power cromo satinato
Power satin chrome



PGS | forte®
Grafite satinato
Satin graphite

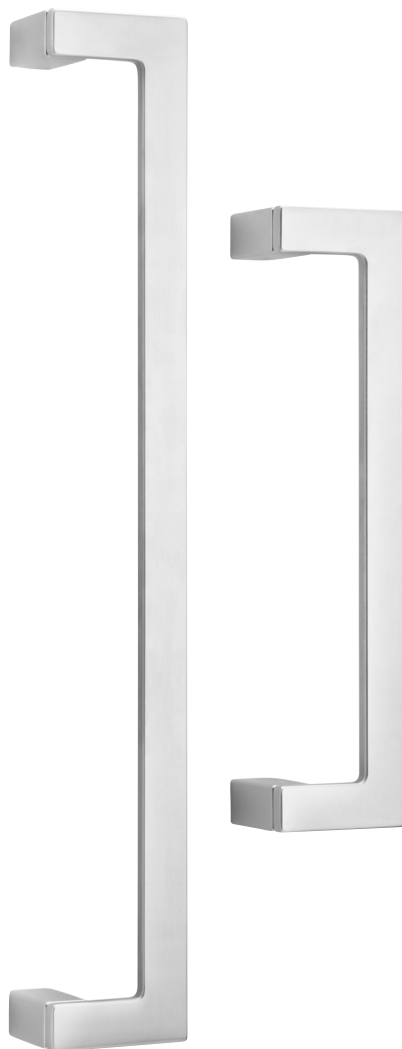
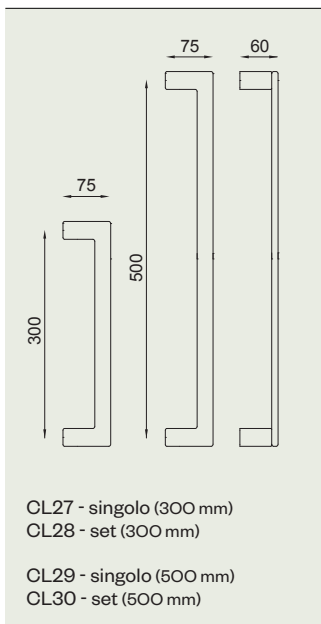

tube round

design: Dnd
technical division

Ottone
Brass

made in italy

-  **PCS**
Power cromo satinato
Power satin chrome
-  **ONO**
Nero
Black
-  **PGS | forte® ***
Grafite satinato
Satin graphite
-  **PVD-SG | forte® ***
Oro antico satinato
Antique satin gold

* **Finitura disponibile
solo per art. TR400 e TR401**
*Finish available only on
art. TR400 and TR401*

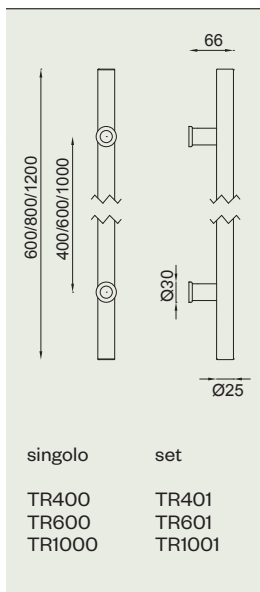

386-

dnd22-23

solid square

design: Dnd
technical division

Ottone forgiato
Forged brass

made in italy

-  **OC**
Power cromo lucido
Power polished chrome
-  **PCS**
Power cromo satinato
Power satin chrome
-  **ONO**
Nero
Black
-  **PGS | forte®***
Grafite satinato
Satin graphite

*** Finitura disponibile
solo per art. SQ400 e SQ401**
*Finish available only on
art. SQ400 and SQ401*

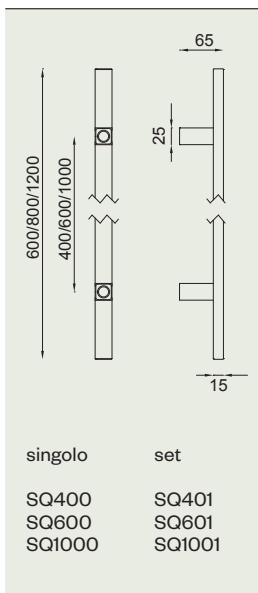

only

Ottone
Solid brass

**design: Dnd
technical division**

made in italy



OLV
Lucido
Polished



AF
Anticato
Antique finish



OGH
Bronzo satinato opaco
Matt satin bronze



OCS
Cromo satinato
Satin chrome

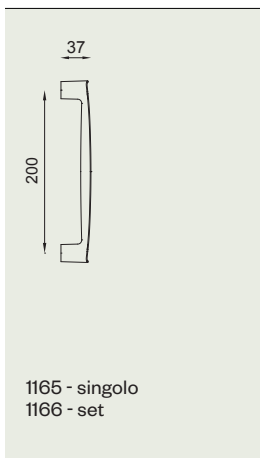

388-

dnd22-23

luce

Zama
Zamak

design: Dnd
technical division

made in italy



ZC
Cromo lucido
Polished chrome



ZCS
Cromo satinato
Satin chrome



ZNE
Nero
Black

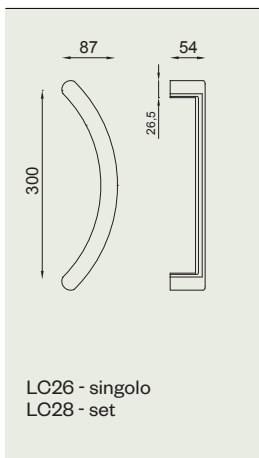

beverly

Ottone stampato a caldo
Hot stamped brass

design: Dnd
technical division

made in italy



OLV
Lucido
Polished



OGH
Bronzo satinato opaco
Matt satin bronze

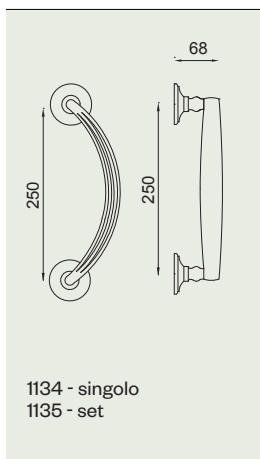

390-

dnd22-23

beverly corto

design: Dnd
technical division

Ottone stampato a caldo
Hot stamped brass

made in italy



OLV
Lucido
Polished



OGH
Bronzo satinato opaco
Matt satin bronze

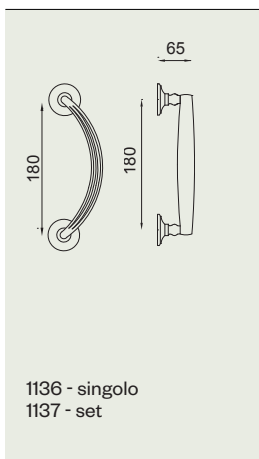

daniela

Ottone
Solid brass

design: Dnd
technical division

made in italy



OLV
Lucido
Polished



AB
Bronzato
Antique bronze



AF
Anticato
Antique finish



FAN
Ferro anticato
Antique iron



ONV
Nickel lucido
Polished nickel

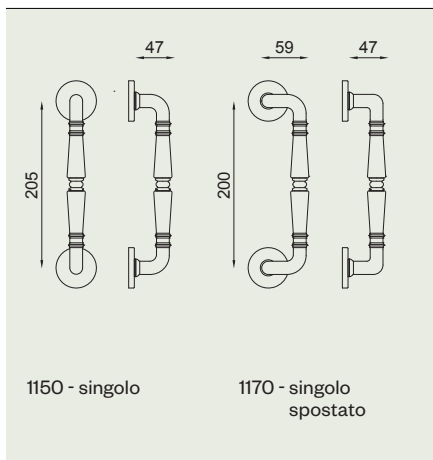

392-

dnd22-23

latina

Ottone stampato a caldo
Hot stamped brass

design:
Mauro Ronchi

made in italy



OGH
Bronzo satinato opaco
Matt satin bronze



BSS
Bronzo scuro sfumato
Shaded dark bronze



PVD | forte®
Ottone lucido
Polished brass

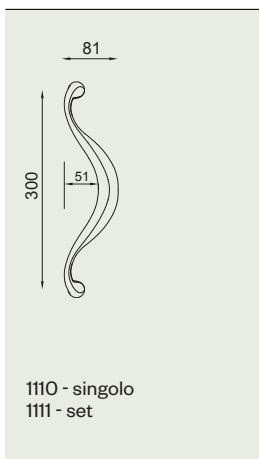

maniglioni

- pull handles
for lift

per alzante
scorrevole

sliding
system

edra

Ottone stampato a caldo
Hot stamped brass

design:
Mauro Ronchi

made in italy

 **OGH**
Bronzo satinato opaco
Matt satin bronze

 **OC**
Power cromo lucido
Power polished chrome

 **PCS**
Power cromo satinato
Power satin chrome

 **ONO**
Nero
Black

 **ONS**
Nickel satinato
Satin nickel

 **PGS | forte®**
Grafite satinato
Satin graphite

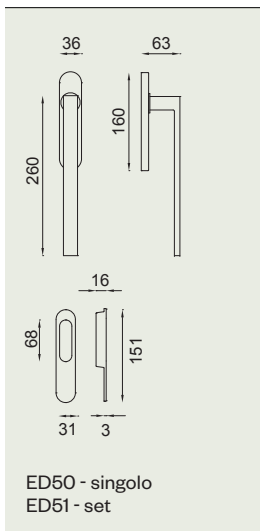

396-

dnd22-23

edra corto

design:
Mauro Ronchi

Ottone stampato a caldo
Hot stamped brass

made in italy



OC
Power cromo lucido
Power polished chrome



PCS
Power cromo satinato
Power satin chrome

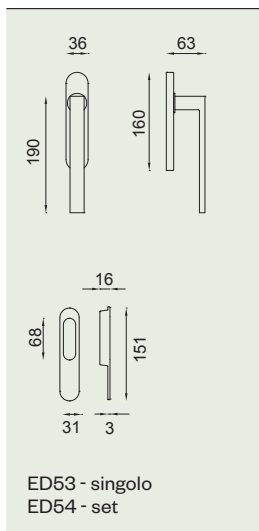

edra 02

design:
Mauro Ronchi

Ottone stampato a caldo
Hot stamped brass

made in italy

 **OGH**
Bronzo satinato opaco
Matt satin bronze

 **OC**
Power cromo lucido
Power polished chrome

 **PCS**
Power cromo satinato
Power satin chrome

 **ONO**
Nero
Black

 **ONS**
Nickel satinato
Satin nickel

 **PGS | forte®**
Grafite satinato
Satin graphite

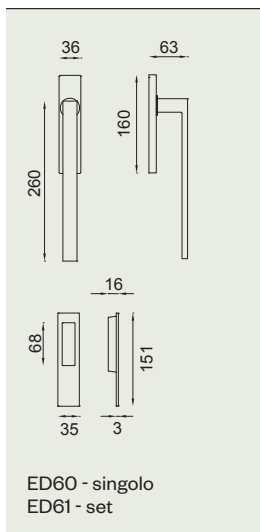

398-

dnd/22-23

edra 02 corto

design:
Mauro Ronchi

Ottone stampato a caldo
Hot stamped brass

made in italy



OC
Power cromo lucido
Power polished chrome



PCS
Power cromo satinato
Power satin chrome

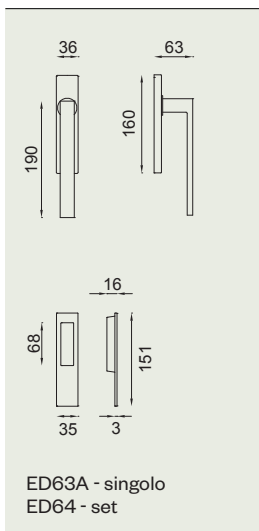

luce

Zama
Zamak

design: Dnd
technical division

made in italy

 **ZGH**
Bronzo satinato opaco
Matt satin bronze

 **ZC**
Cromo lucido
Polished chrome

 **ZCS**
Cromo satinato
Satin chrome

 **ZNE**
Nero
Black

 **ZNS**
Nickel satinato
Satin nickel

 **ZAN**
Antracite
Anthracite

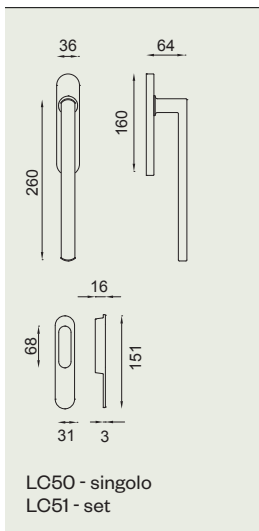

400-

dnd22-23

luce 02

design: Dnd
technical division

Zama
Zamak

made in italy



ZGH
Bronzo satinato opaco
Matt satin bronze



ZC
Cromo lucido
Polished chrome



ZCS
Cromo satinato
Satin chrome



ZNE
Nero
Black



ZNS
Nickel satinato
Satin nickel



ZAN
Antracite
Anthracite

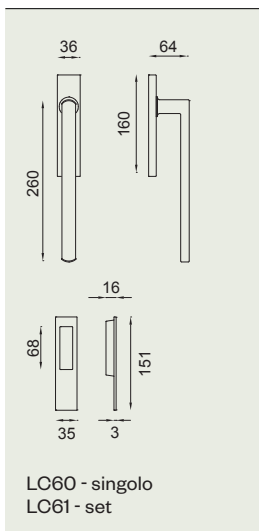

slide

Ottone stampato a caldo
Hot stamped brass

design:
Mauro Ronchi

made in italy



OLV
Lucido
Polished



OC
Power cromo lucido
Power polished chrome



PCS
Power cromo satinato
Power satin chrome



ONS
Nickel satinato
Satin nickel

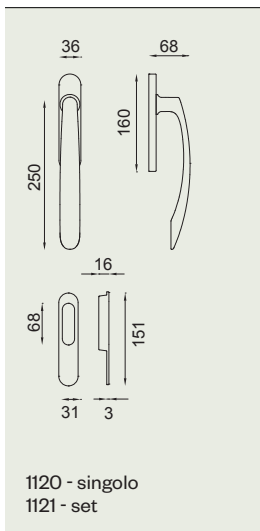

402-

dnd22-23

slide corto

design:
Mauro Ronchi

Ottone stampato a caldo
Hot stamped brass

made in italy



OLV
Lucido
Polished



OC
Power cromo lucido
Power polished chrome



PCS
Power cromo satinato
Power satin chrome

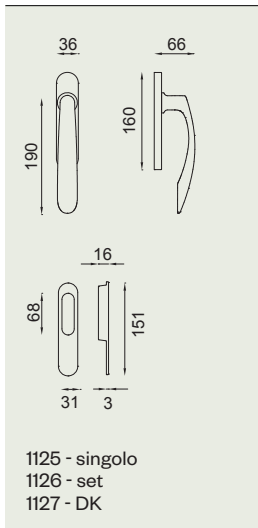

liter

Ottone
Brass

design: Dnd
technical division

made in italy



OLV
Lucido
Polished



OCS
Cromo satinato
Satin chrome

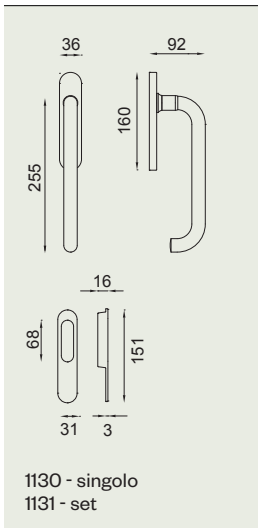

404-

dnd22-23

placche incasso

Ottone stampato a caldo
Hot stamped brass



OLV
Lucido
Polished



OGH
Bronzo satinato opaco
Matt satin bronze



OC
Power cromo lucido
Power polished chrome



PCS
Power cromo satinato
Power satin chrome



ONS
Nickel satinato
Satin nickel



PGS | forte®
Grafite satinato
Satin graphite



TAN
Antracite
Anthracite

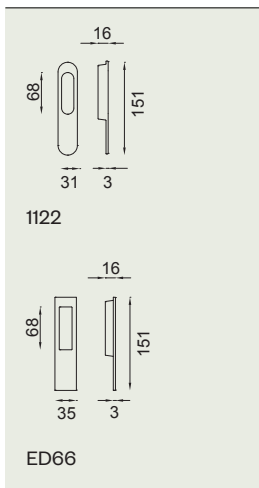

– knobs

pomoli

lucrezia

Ottone forgiato
Forged brass

design:
Marco Pisati

made in italy

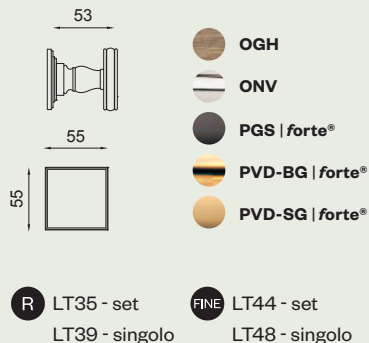

lucrezia 02

Ottone forgiato
Forged brass

design:
Marco Pisati

made in italy

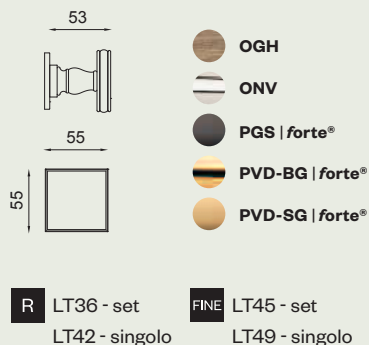

lucrezia 03

Ottone forgiato
Forged brass

design:
Marco Pisati

made in italy

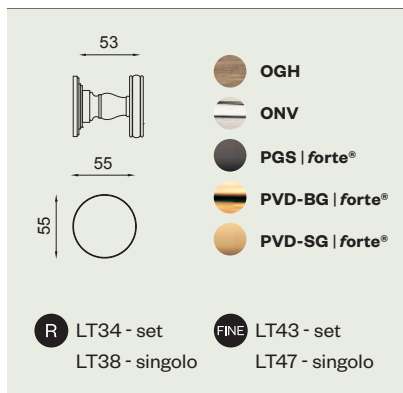

ring

Ottone forgiato
Forged brass

design: **Dnd**
technical division

made in italy

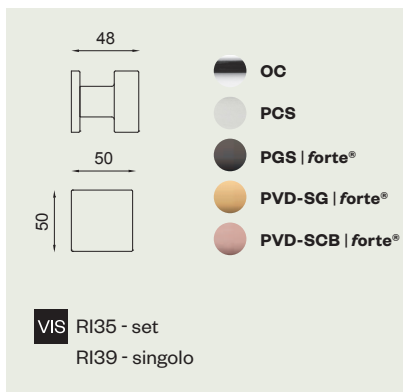

rondò

Ottone forgiato
Forged brass

design: Dnd
technical division

made in italy

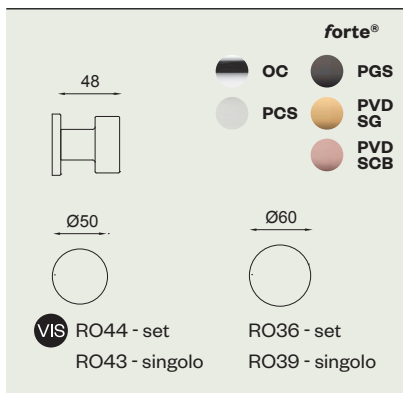

easy

Ottone
Solid brass

design: Dnd
technical division

made in italy



timeless

Alluminio
Aluminium

design:
Marco Pisati

made in italy

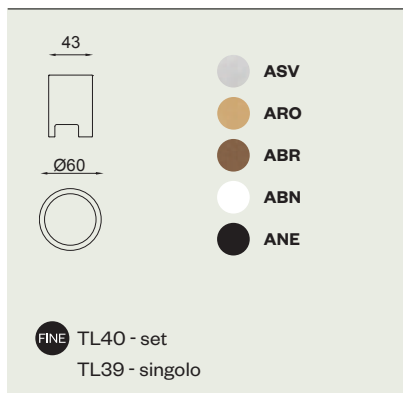

project

Ottone
Solid brass

design: **Dnd**
technical division

made in italy

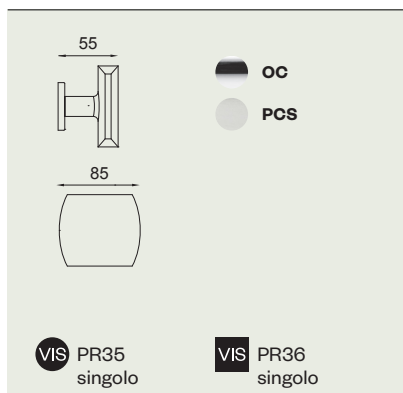

quadro

Ottone
Solid brass

design: Dnd
technical division

made in italy

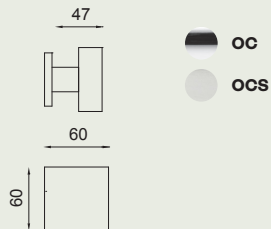

VIS 1575 - singolo

sfera

Ottone
Solid brass

design: Dnd
technical division

made in italy



1570 - singolo

fiorenza

Ottone stampato a caldo
Hot stamped brass

design: Dnd
technical division

made in italy

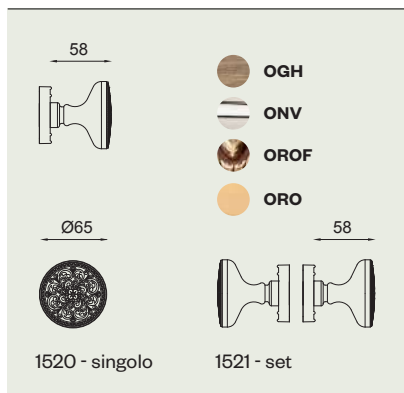

ovale centrale

Ottone
Solid brass

design: Dnd
technical division

made in italy

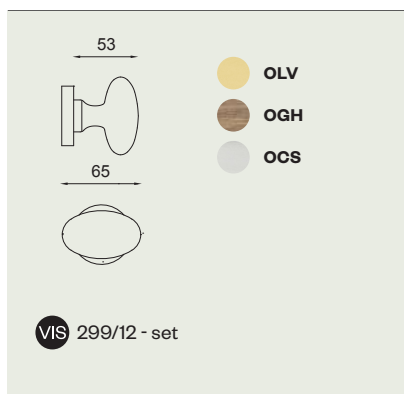

pomolini per mobili *furniture knobs*



Alluminio
Aluminium

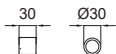

timeless

design: Marco Pisati

TL70
mm. 30



ASV



ARO



ABR



ABN



ANE



Ottone
Solid brass

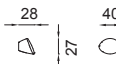

AR40
ART



Ottone
Solid brass

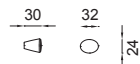

FL40
FLUÒ



Ottone
Solid brass



GO40
GO



OLV



OC



PCS

accessori per mobili lucrezia *lucrezia furniture accessories*

Ottone forgiato
Forged brass

design:
Marco Pisati

made in italy

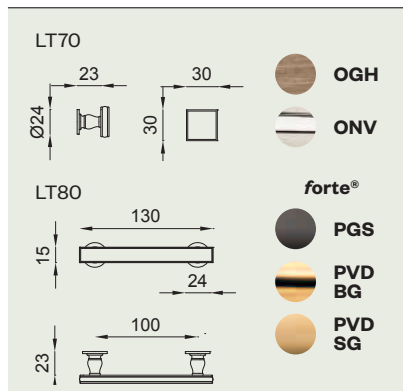

maniglie

– sliding
door

per porte
scorrevoli

handles

ginkgo tonda

Ottone e zama
Brass and zamak

design:
Giulio Iacchetti

made in italy

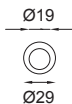
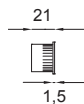

2191
frontale per scorrevole
*sliding door flush
pull hole*

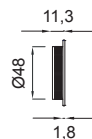

SD500
rosetta incasso
sliding door handle

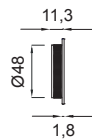

SD500P
rosetta incasso
foro chiave
*sliding door handle
key hole*



SD501
set rosette incasso
con frontale
*sliding door handle set
with flush pull hole*



SD503
set rosette incasso con
nottolino q. 8 mm. con
frontale
*sliding door handle set
with turn and release
8 mm square
spindle and flush
pull hole*

ginkgo tonda

design:
Giulio Iacchetti

Ottone e zama
Brass and zamak

made in italy



SD505

set rosette incasso foro chiave con
frontale + serratura

*sliding door handle set key hole with
flush pull hole + lock*

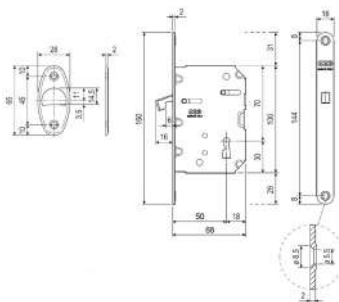
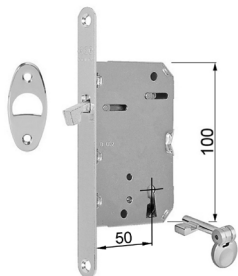

SE107

OC

OCS

ONO



SD506

set rosette incasso con nottolino \varnothing 8 mm
con frontale + serratura

*sliding door handle set with turn and
release 8 mm square spindle with flush
pull hole + lock*

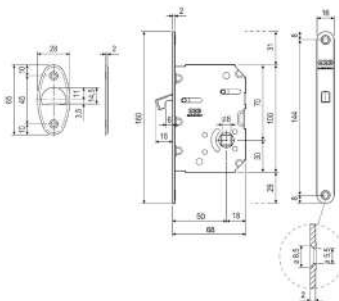
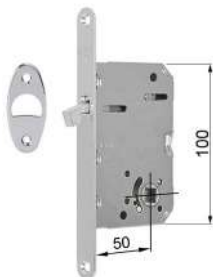

SE108

ginkgo quadra

design:
Giulio Iacchetti

Ottone e zama
Brass and zamak

made in italy

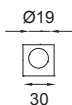

2189
frontale per scorrevole
*sliding door flush
pull hole*

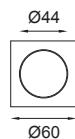
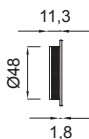

SD520
rosetta incasso
sliding door handle

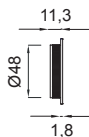



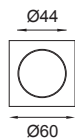



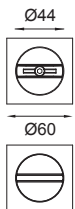

SD520P
rosetta incasso
foro chiave
*sliding door handle
key hole*

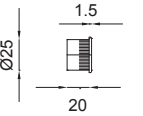

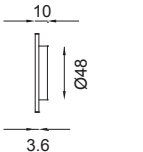
SD521
set rosette incasso
con frontale
*sliding door handle set
with flush pull hole*

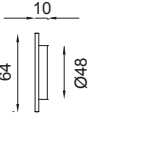

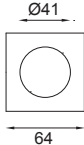
SD523
set rosette incasso con
nottolino q.8 mm. con
frontale
*sliding door handle set
with turn and release
8 mm square
spindle and flush
pull hole*

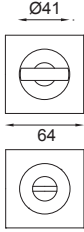
		<p>2189 frontale per scorrevole <i>sliding door flush pull hole</i></p>
		<p>SD220 rosetta incasso <i>sliding door handle</i></p>
		<p>SD221 rosetta incasso foro chiave <i>sliding door handle key hole</i></p>
		<p>SD222 set rosette incasso con frontale <i>sliding door handle set with flush pull hole</i></p>
		<p>SD224 set rosette incasso con nottolino q. 8 mm con frontale <i>sliding door handle set with turn and release 8 mm square spindle and flush pull hole</i></p>

-  **AB**
-  **OGH**
-  **OC**
-  **PCS**
-  **OBN**
-  **ONO**
-  **ONS**

forte®

-  **PVD BG**
-  **PVD SG**
-  **PVD SCB**
-  **PVD**
-  **PGS**
-  **PVX**



SD225

set rosette incasso foro chiave con
frontale + serratura

*sliding door handle set key hole with
flush pull hole + lock*

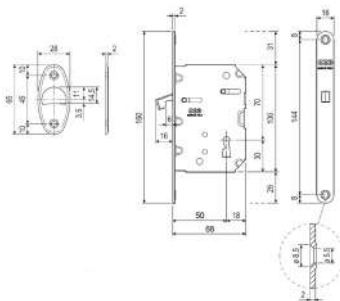
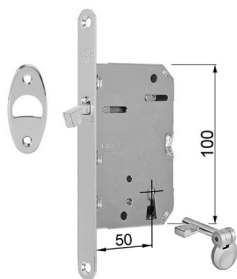

SE107



SD226

set rosette incasso con nottolino q.8 mm
con frontale + serratura

*sliding door handle set with turn and
release 8 mm square spindle with flush
pull hole + lock*

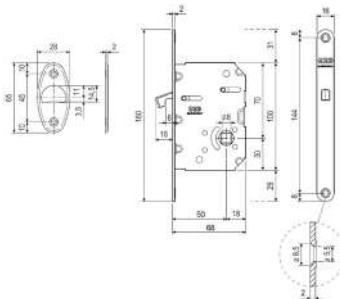
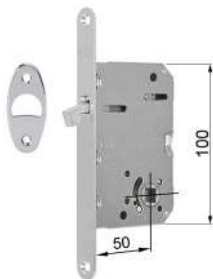

SE108



forte®











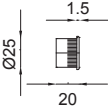
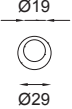

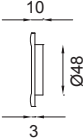



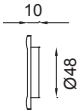





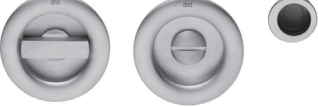
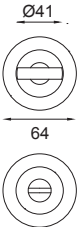

rondò

Ottone
Solid brass

design: Dnd
technical division

made in italy

			2191 frontale per scorrevole <i>sliding door flush pull hole</i>	
			SD200 rosetta incasso <i>sliding door handle</i>	 OLV
			SD201 rosetta incasso foro chiave <i>sliding door handle key hole</i>	 AB  OGH  OC  PCS
			SD202 set rosette incasso con frontale <i>sliding door handle set with flush pull hole</i>	 OBN  ONO  ONS
			SD204 set rosette incasso con nottolino q. 8 mm con frontale <i>sliding door handle set with turn and release 8 mm square spindle and flush pull hole</i>	forte®  PVD BG  PVD SG  PVD SCB  PVD  PGS  PVX

quadra

Ottone
Solid brass

design: Dnd
technical division

made in italy

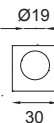
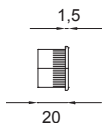

2189
frontale per scorrevole
*sliding door flush
pull hole*

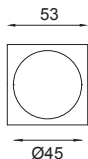
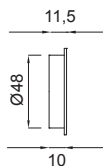

2185
rosetta incasso
sliding door handle

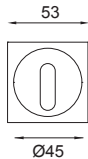
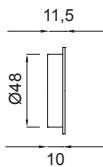

2185/F
rosetta incasso
foro chiave
*sliding door handle
key hole*

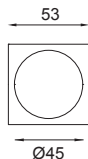
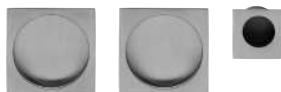

2185/S1
set rosette incasso
con frontale
*sliding door handle set
with flush pull hole*

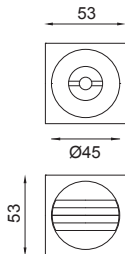

2186/S
set rosette incasso con
nottolino q. 8 mm con
frontale
*sliding door handle set
with turn and release
8 mm square
spindle and flush
pull hole*



OC



OCS

quadra

design: Dnd
technical division

Ottone
Solid brass

made in italy



2185/SE107

set rosette incasso foro chiave
con frontale + serratura

*sliding door handle set key hole with
flush pull hole + lock*

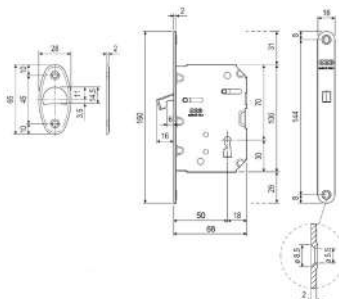
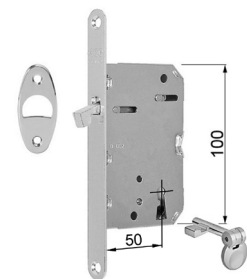

SE107



OC



OCS



2186/SE108

set rosette incasso con nottolino q.8 mm
con frontale + serratura

*sliding door handle set with turn and
release 8 mm square spindle with flush
pull hole + lock*

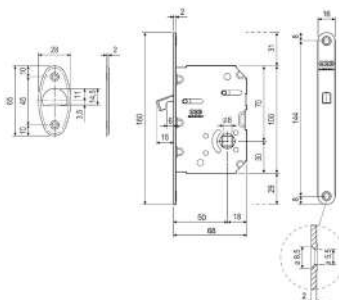
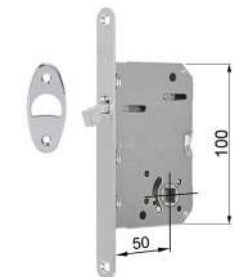











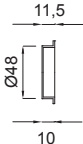
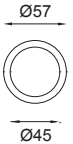

SE108

tonda

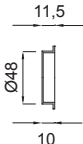
Ottone
Solid brass

design: Dnd
technical division

made in italy

			<p>2191 frontale per scorrevole <i>sliding door flush pull hole</i></p>
			<p>2193 rosetta incasso <i>sliding door handle</i></p>
			<p>2193/F rosetta incasso foro chiave <i>sliding door handle key hole</i></p>
			<p>2193/S1 set rosette incasso con frontale <i>sliding door handle set with flush pull hole</i></p>
			<p>2194/S set rosette incasso con nottolino q. 8 mm con frontale <i>sliding door handle set with turn and release 8 mm square spindle and flush pull hole</i></p>

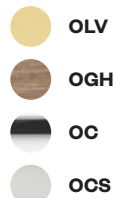





rettangolare

design: Dnd
technical division

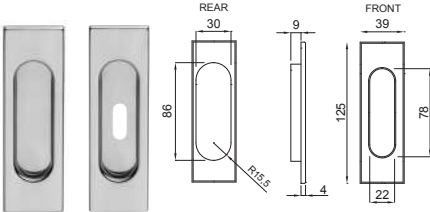
Ottone
Brass

made in italy

	<p>2187 placchetta incasso coprivate <i>sliding door handle concealed fixing</i></p> <p>2187/F placchetta incasso coprivate con foro chiave <i>sliding door handle key hole concealed fixing</i></p>
	<p>2187/S1 set placchette incasso con frontale <i>sliding door handle set with flush pull hole</i></p>
	<p>2187/SE107 set placchette incasso foro chiave con frontale + serratura <i>sliding door handle set key hole with flush pull hole + lock</i></p>
	<p>2187/S set placchette incasso con nottolino q. 8 mm e frontale <i>sliding door handle set with turn and release 8 mm square spindle and flush pull hole</i></p>
	<p>2187/SE108 set placchette incasso con nottolino q.8 mm con frontale e serratura <i>sliding door handle set with turn and release 8 mm sq. spindle with flush pull hole + lock</i></p>



Ottone
Brass

made in italy

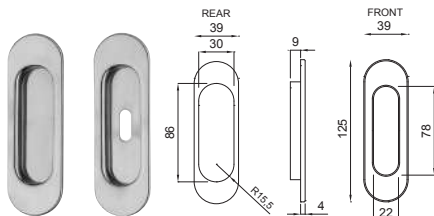

2197
placchetta incasso coprivite
sliding door handle
concealed fixing

2197/F
placchetta incasso coprivite
con foro chiave
sliding door handle key hole
concealed fixing



2197/S1
set placchette incasso con
frontale
sliding door handle set with
flush pull hole



2197/SE107
set placchette incasso foro
chiave con frontale
+ serratura
sliding door handle set
key hole with flush pull hole
+ lock



2197/S
set placchette incasso con
nottolino q. 8 mm e frontale
sliding door handle set with
turn and release 8 mm square
spindle and flush pull hole



2197/SE108
set placchette incasso con
nottolino q. 8 mm con frontale
e serratura
sliding door handle set with
turn and release 8 mm sq.
spindle with flush pull hole
+ lock



OLV



OGH



OC



OCS



ONO

articoli

—

vari

other
complements

nottolino dnd *dnd turn & release*

design:
Mauro Ronchi

ottone
solid brass

finiture / finishes:
OLV OS AB OGH OC
PCS ONV ONS
forte®
PVD PVX PGS
PVD-BG PVD-SG

made in italy



NODN1
nottolino Dnd
Dnd turn & release



VIS **RDN08+A**
set nottolino su rosetta
turn & release set on rose
50x7mm - VIS

52 **RDN03+A**
set nottolino su rosetta
turn & release set on rose
52x10mm - 52



FINE **RDN44+A**
set nottolino su rosetta
turn & release set on rose
50x4mm - FINE

FINE **RDN45+A**
set nottolino su rosetta quadra
turn & release set on square rose
50x4mm - FINE



VIS

RDN09+A

set nottolino su rosetta quadra
turn & release set on square rose
50x7mm - VIS

52

RDN05+A

set nottolino su rosetta quadra
smussata / *turn & release set on*
chamfered square rose
52x10mm - 52



R

RDN18+A

set nottolino su rosetta
turn & release set on rose
45x50mm - ARDEA

R

RDN19+A

set nottolino su rosetta
turn & release set on rose
50x60mm - CASSIA

nottolino short

short turn & release

design:
Dnd technical division

ottone
solid brass

finiture / finishes:
OLV OS AB OGH OC
PCS ONV ONS

forte®
PVD PVX PGS PVD-BG
PVD-SG PVD-SCB

made in italy



NODN20

nottolino Short
Short turn & release



VIS

RDN25+A

set nottolino su rosetta
turn & release set on rose
50x7mm - VIS

52

RDN27+A

set nottolino su rosetta
turn & release set on rose
52x10mm - 52



FINE

RDN20+A

set nottolino su rosetta
turn & release set on rose
50x4mm - FINE

VIS

RDN26+A

set nottolino su rosetta quadra
turn & release set on square rose
50x7mm - VIS



52

RDN28+A

set nottolino su rosetta quadra
turn & release set on square rose
52x10mm - 52

FINE

RDN21+A

set nottolino su rosetta quadra
turn & release set on square rose
50x4mm - FINE

nottolino logo *logo turn & release*

design:
Mauro Ronchi

ottone
solid brass

finiture / finishes:
OLV OS AB OGH OC
PCS ONV ONS
forte[®]
PVD PVX PGS PVD-BG
PVD-SG PVD-SCB

made in italy



NODN10
nottolino logo
logo turn & release



VIS **RDN12+A / RDN 12X+A (Inox)**
set nottolino su rosetta
turn & release set on rose
50x7mm - VIS

52 **RDN13+A**
set nottolino su rosetta
turn & release set on rose
52x10mm - 52



FINE **RDN40+A**
set nottolino su rosetta
turn & release set on rose
50x4mm - FINE



VIS

RDN14+A

set nottolino su rosetta quadra
turn & release set on square rose
50x7mm - VIS

52

RDN15+A

set nottolino su rosetta quadra
turn & release set on square rose
52x10mm - 52



FINE

RDN41+A

set nottolino su rosetta quadra
turn & release set on square rose
50x4mm - FINE

nottolino lucrezia

lucrezia turn & release

design:
Marco Pisati

ottone
solid brass

finiture / finishes:
OGH ONV
forte®
PGS PVD-BG PVD-SG

made in italy



NODN30

nottolino lucrezia
lucrezia turn & release



R **RDN30+A**
set nottolino su rosetta
turn & release set on rose
53x8mm - LUCREZIA

FINE **RDN31+A**
set nottolino su rosetta
turn & release set on rose
50x4mm - FINE



R **RDN33+A**
set nottolino su rosetta quadra
turn & release set on square rose
53x8mm - LUCREZIA

FINE **RDN32+A**
set nottolino su rosetta quadra
turn & release set on square rose
50x4mm - FINE

nottolino timeless

timeless turn & release

design:
Marco Pisati

Alluminio
Aluminium

finiture / finishes:
ASV ARO ABR ABN ANE
ABT AGO AVP ABC

made in italy



NODN50

nottolino timeless
timeless turn & release



FINE

RDN50+A

set nottolino su rosetta
turn & release set on rose
50x4mm - FINE

nottolino (IN)finito (IN)finito turn & release

design:
Alfonso Femia

ottone
solid brass

finiture / finishes:
OLV AB SO PCS ONO

made in italy



NODN66

nottolino (IN)finito
(IN)finito turn & release



R

RDN66+A
set nottolino su rosetta
minimale (IN)finito
*turn & release set on
minimal (IN)finito rose*
25x50mm - (IN)finito

FINE

RDN75+A
set nottolino su rosetta
turn & release set on rose
50x4mm - FINE



FINE

RDN76+A
set nottolino su rosetta quadra
turn & release set on square rose
50x4mm - FINE

nottolino DUE

DUE turn & release

design:
Stefano Boeri
Architetti

ottone
solid brass

finiture / finishes:
PCS ONO
forte® PGS PVD-SG

made in italy



NODN65
nottolino DUE
DUE turn & release

FINE

RDN68+A
set nottolino su rosetta
turn & release set on rose
50x4mm - FINE



FINE

RDN69+A
set nottolino su rosetta quadra
turn & release set on square rose
45mm

45

RDN74+A
set nottolino su rosetta quadra
turn & release set on square rose
45mm



R

RDN80+A
set nottolino su rosetta
turn & release set on rose
53x8mm - LUCREZIA

R

RDN81+A
set nottolino su rosetta quadra
turn & release set on square rose
53x8mm - LUCREZIA

nottolino tedesco

tedesco turn & release

design:
Dnd technical division

ottone
solid brass

finiture / finishes:
OLV OS AB OGC AF OGH
OC OCS ONS FAN ONV

made in italy



2279

nottolino tedesco
tedesco turn & release



VIS

2402+A

set nottolino su rosetta
turn & release set on rose
50x7mm - VIS

FINE

2291+A

set nottolino su rosetta
turn & release set on rose
50x4mm - FINE



B

2286+A

set nottolino su rosetta
turn & release set on rose
50mm - B

V

2280+A

set nottolino su rosetta
turn & release set on rose
40x60mm - V



R

2315+A

set nottolino su rosetta
turn & release set on rose
55mm - FIRENZA



R

2300+A

set nottolino su rosetta
turn & release set on rose
63x52mm - LATINA

OLV
OGH
ORO
OROF
ONV



52

2452+A

set nottolino su rosetta
turn & release set on rose
52x10mm - 52

nottolino blend

blend turn & release

design:
Dnd technical division

ottone
solid brass

finiture / finishes:
OLV OS AB OGC
AF OC OCS ONS FAN ONV
forte®
PGS PVD-BG PVD-SG

made in italy



2281
nottolino blend
blend turn & release



VIS **2403+A**
set nottolino su rosetta
turn & release set on rose
50mm - VIS

VIS **2405+A**
set nottolino su rosetta quadra
turn & release set on square rose
50mm - VIS



V **2288+A**
set nottolino su rosetta
turn & release set on rose
40x60mm - V

B **2284+A**
set nottolino su rosetta
turn & release set on rose
50mm - B



FINE

2406+A

set nottolino su rosetta
turn & release set on rose
50x4mm - FINE

FINE

2407+A

set nottolino su rosetta quadra
turn & release set on square rose
50x4mm - FINE



R

2408+A

set nottolino su rosetta
turn & release set on rose
53x8mm - LUCREZIA

52

2409+A

set nottolino su rosetta
turn & release set on rose
52x10mm - 52



52

2412+A

set nottolino su rosetta quadra
turn & release set on square rose
52x10mm - 52

U

2413+A

set nottolino Blend
su rosetta Unico
*Blend turn & release
set on Unico rose*
30x2mm - UNICO

nottolino joy

joy turn & release

design:
Dnd technical division

zama
zamak

finiture / finishes:
ZOS ZC ZGH ZCS
ZNE ZBN ZNS ZAN

made in italy



JYDN10

nottolino joy
joy turn & release

2303+A

set nottolino su
rosetta stretta R023
turn & release set
on R023 narrow rose
30x60mm

2305+A

set nottolino su
rosetta stretta R016
turn & release set
on R016 narrow rose
30x60mm



VIS

RDN22+A

set nottolino su rosetta
turn & release set on rose
50x7mm - VIS

VIS

RDN24+A

set nottolino su rosetta quadra
turn & release set on square rose
50x7mm - VIS



FINE

RDN47+A

set nottolino su rosetta
turn & release set on rose
50x4mm - FINE

FINE

RDN48+A

set nottolino su rosetta quadra
turn & release set on square rose
50x4mm - FINE

nottolini su rosette strette *turn & releases on narrow roses*

design:
Dnd technical division

ottone
solid brass

finiture / finishes:
OLV OS AB AF OGH
OGC OC OCS PCS ONS
FAN ONV OBN ONO

made in italy

forte®
PVD PVX PGS



RDN60+A
set nottolino dnd
su rosetta stretta RO16
*dnd turn & release set
on RO16 narrow rose*
30x60mm



RDN61+A
set nottolino dnd
su rosetta stretta dnd
*dnd turn & release set
on dnd narrow rose*
30x60mm



RDN62+A
set nottolino logo
su rosetta stretta RO16
*logo turn & release set
on RO16 narrow rose*
30x60mm



RDN63+A
set nottolino logo
su rosetta stretta dnd
*logo turn & release set
on RO16 narrow dnd rose*
30x60mm



2290+A
set nottolino tedesco
su rosetta stretta RO16
*tedesco turn & release
set on RO16 narrow rose*
30x60mm



2301+A
set nottolino blend
su rosetta stretta RO16
*blend turn & release set
on RO16 narrow rose*
30x60mm



2304+A
set nottolino blend
su rosetta stretta RO23
*blend turn & release set
on RO23 narrow rose*
30x60mm



RDN34+A
set nottolino short
su rosetta stretta
*short turn & release set
on narrow rose*
30x60mm



RDN35+A
set nottolino short su
rosetta stretta
*short turn & release set
on narrow rose*
30x60mm

bocchette tonde *round escutcheons*

design:
Dnd technical division

ottone
solid brass

finiture / finishes:
OLV OS AB AF OGH OGC OC OCS
PCS ONV ONS FAN OBN ONO ORO
forte®
PVD PVX PGS PVD-BG
PVD-SG PVD-SCB

made in italy



VIS **BD12P / BD12Y**
bocchetta
escutcheon
50x7mm - VIS

45 **BD01P / BD01Y**
bocchetta
escutcheon
45x10mm - dnd



VIS **BD12XP / BD12XY (Inox)**
bocchetta
escutcheon
50x7mm - VIS

52 **BD03P / BD03Y**
bocchetta
escutcheon
52x10mm - 52



FINE

BD40P / BD40Y
bocchetta 4mm
escutcheon 4mm
50x4mm - FINE



B

BO20P / BO20Y
bocchetta bombata
rounded escutcheon
50mm - B



VIS

BD35
bocchetta cieca
blind escutcheon
50x7mm - VIS



VIS

BD36
bocchetta doppia mappa
escutcheon special key hole
50x7mm - VIS

bocchette quadre *square escutcheons*

design:
Dnd technical division

ottone
solid brass

finiture / finishes:
OLV OS AB OGH OC
PCS ONS OBN ONO
forte®
PVD PVX PGS PVD-BG
PVD-SG PVD-SCB

made in italy



VIS

BD14P / BD14Y
bocchetta quadra
square escutcheon
50x7mm - VIS

45

BD06P / BD06Y
bocchetta quadra
square escutcheon
45mm



52

BD04P / BD04Y
bocchetta quadra
square escutcheon
52x10mm - 52

52

BD05P / BD05Y
bocchetta quadra smussata
chamfered square escutcheon
52x10mm - 52



FINE

BD41P / BD41Y

bocchetta quadra 4 mm
square escutcheon 4 mm
50x4mm - FINE



VIS

BD37

bocchetta quadra cieca
blind square escutcheon
50x7mm - VIS

VIS

BD38

bocchetta quadra doppia
mappa / *square escutcheon*
special key hole
50x7mm - VIS

bocchette speciali *special escutcheons*

design:
Dnd technical division

ottone
solid brass

finiture / finishes:
OLV OS AB OGC AF OC OCS PCS
ONS FAN ONV OBN ONO
forte®
PVD PVX PGS PVD-BG
PVD-SG PVD-SCB

made in italy



S **BO16P / BO16Y**
bocchetta
escutcheon
30x60mm

S **BD61P / BD61Y**
bocchetta rettangolare dnd
dnd rectangular escutcheon
30x60mm

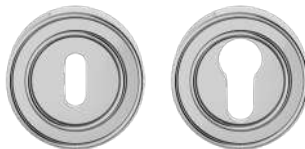

S **BO23P / BO23Y**
bocchetta
escutcheon
30x60mm

B **BF10P / BF10Y** OGH
bocchetta fiorenza ONV
fiorenza escutcheon OROF
55mm ORO

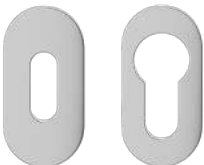

NEW

U **BD80P / BD80Y**
bocchetta UNICO
UNICO escutcheon
25x2mm

bocchette speciali *special escutcheons*

design:
Dnd technical division

ottone
solid brass

finiture / finishes:
OLV OS AF AB OGC
OGH BSS FAN ONV
forte®
PVD-BG PVD-SG PGS

made in italy



R **BD30P / BD30Y**
bocchetta cassia
cassia escutcheon
50x60mm

R **BD31P / BD31Y**
bocchetta ardea
ardea escutcheon
45x50mm



R **BO42P / BO42Y**
bocchetta latina
latina escutcheon
45x50mm

V **BO14P / BO14Y**
bocchetta ovale
oval escutcheon
40x60mm



R **BD32P / BD32Y**
bocchetta lucrezia
lucrezia escutcheon
53x8m - R

R **BD33P / BD33Y**
bocchetta lucrezia
lucrezia escutcheon
53x8m - R

fermaporta door stop

design: ottone
Dnd technical division solid brass

made in italy



2268/1
fermaporta classic a parete
classic on wall door stop
35x87



2268
fermaporta classic a
pavimento / *classic on floor*
door stop
42x96mm

OLV
OGH
OC
OCS
ORO



RI200
fermaporta ring
ring door stop
30x30mm

OLV ONS
OGH ONO
OC PGS
PCS



2265 leggero/light
2265/P pesante/heavy
fermaporta cilindro
door stop
29x45mm

OLV
OGH
OC
OCS
ONS
ONO



2264
fermaporta chiocciola
door stop
45mm

OLV ONS
OGH ONO
OC
OCS

chiavi keys

ottone stampato a caldo
hot stamped brass

finiture / finishes:

OLV OS AB OC PCS ONS OBN ONO
forte[®]
PGS PVD-BG PVD-SG PVD-SCB



DO1C
chiave dolce
dolce key



VI1C
chiave vita
vita key

cerniere – copricerniere *hinges – cover hinges*

ottone
solid brass

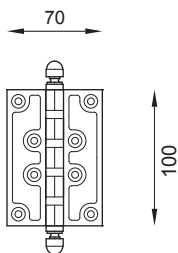

2307
cerniera classic
classic hinge

OLV
OS
AF
AB
OGC
OGH
FAN

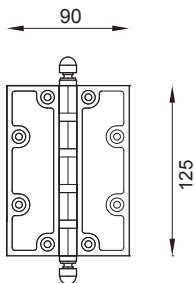

2307/1
cerniera classic
classic hinge

OLV
OS
AF
AB
OGC
OGH
FAN

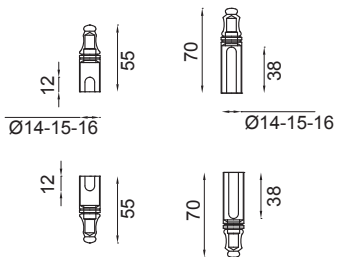

2313

set copricerniere corto con
piramide / *short cover hinges
set with pyramid*

2313/2

set copricerniere lungo con
piramide asole lunghe / *long
cover hinges set with pyramid
long holes*

OLV
OS
AF
AB
OGC
OGH
FAN

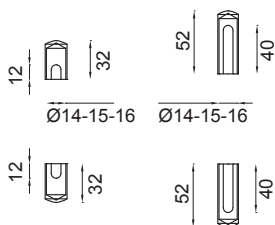

2314

set copricerniere corto piatto
flat short cover hinges set

2314/2

set copricerniere lungo con
asole lunghe e corte / *long
cover hinges set with long or
short holes*

OLV
OC
OCS
ONS

placche plates

ottone
solid brass



PL829 latina
57x265mm



PL570 classic
46x252mm



PL310 noxia
40x251mm



PL169 quadra
42x245mm



PLD01 dnd
245mm



PL279 sabina
38x236mm



PL390 daniela
40x247mm



PL580 cassia
55X250mm



PL560 ardea
48X252mm



PL520 fiorenza
65X320mm



PL550 lucrezia
53X300mm



PL400 slide
35X160mm



PL283 sabina
35X175mm



PL394 daniela
37X170mm



PL401 slide q.
35X160mm

note / notes

A large grid of graph paper, consisting of 20 columns and 25 rows of small squares, intended for taking notes.

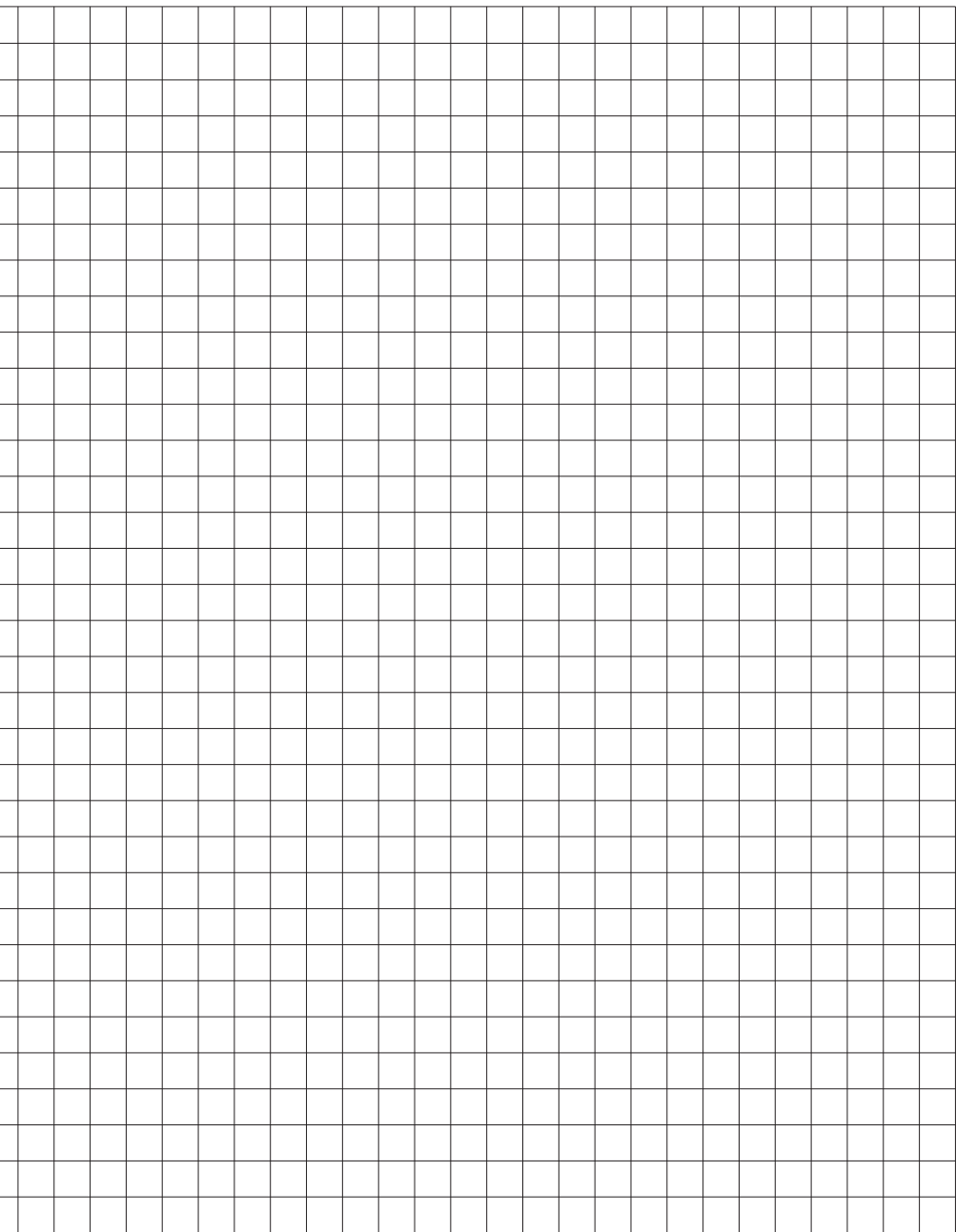

note / notes

A large grid of graph paper, consisting of 20 columns and 25 rows of small squares, occupies the majority of the page below the title.

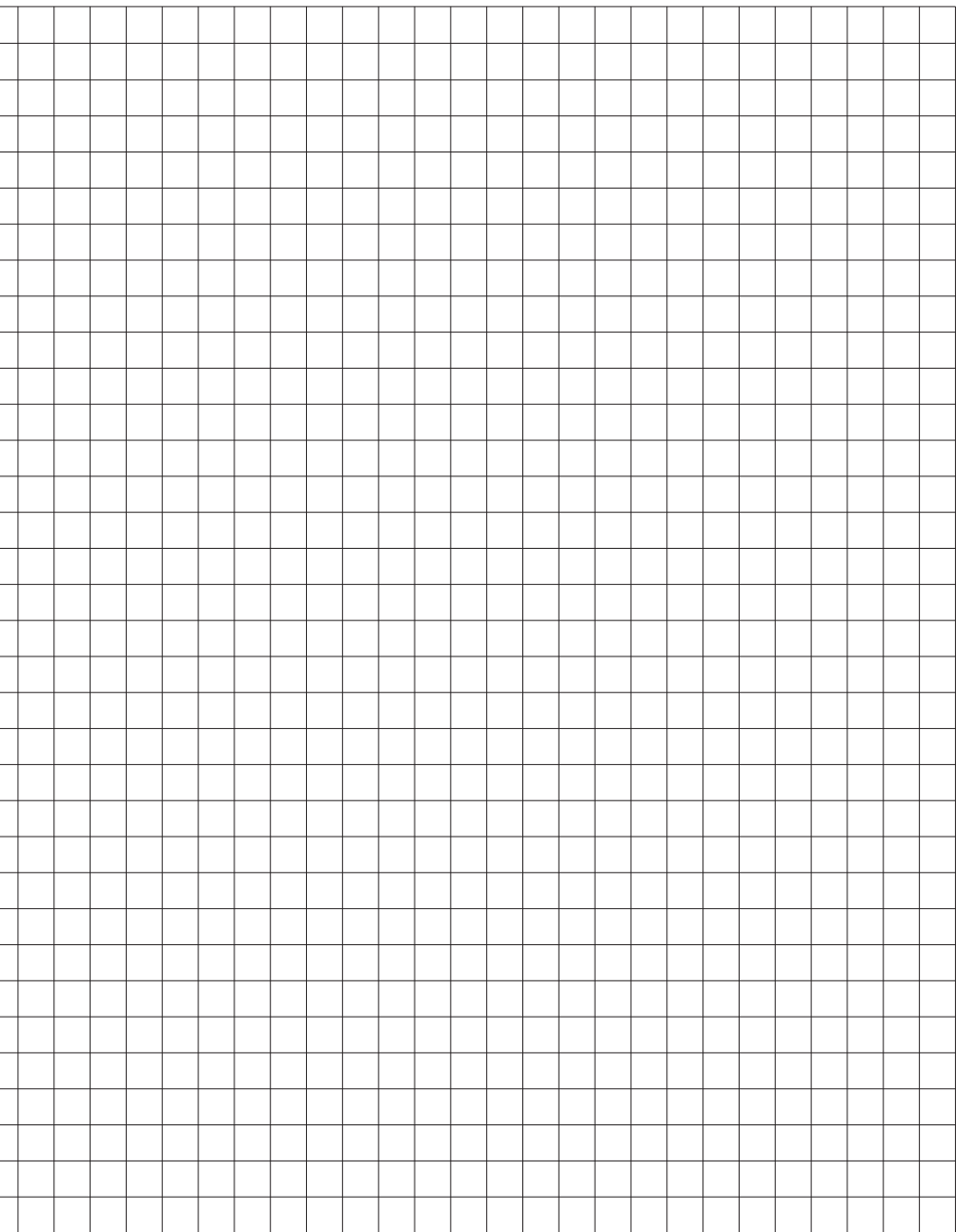

Copertina /

Cover

Leonardo Sonnoli

Irene Bacchi

- Studio Sonnoli -

Progetto grafico /

Graphic design

Lorenzo De Bon

Marco Tonet

- Webkolm -

Su progetto grafico originario /

On original graphic project

- Studio Sonnoli -

Fotografie /

Photographs

Tiziano Reguzzi

Stampa / Printing

Tipolitografia Pagani



Dnd Martinelli S.r.l.

Località Piani di Mura, 2
25070 Casto (BS) - Italia

T +39 0365 899113

info@dndhandles.it

www.dndhandles.it



© 2022 Dnd Martinelli S.r.l.

Tutti i diritti riservati

All rights reserved

dnd

handles
with care

dndhandles.it
made in italy

