



About us

VillaRe è un marchio italiano di eccellenza nella progettazione di porte.

La produzione aperta anni fa, VillaRe fornisce i suoi prodotti attraverso canali specifici, con rivenditori basati in tutto il territorio nazionale e oltre.

Il design VillaRe è apprezzato a livello internazionale e la qualità completamente italiana è un plus inimitabile.

Dalla sua nascita, il marchio VillaRe, ha sempre puntato all'innovazione come strumento di crescita considerando la porta come elemento di arredo caratterizzante in un ambiente.

L'innovazione riguarda anche le scelte produttive delle porte VillaRe, in cui viene considerato l'impatto ambientale di ogni fase e dei materiali di prima qualità utilizzati.

Dietro al marchio VillaRe ci sono professionisti e artigiani esperti nelle lavorazioni, che sanno come fare di un prodotto il meglio, sanno esaltarne i materiali e le peculiarità.

In VillaRe pensiamo in grande ogni giorno e spesso riusciamo a realizzare ciò che fino ad un attimo prima sembrava essere solo una grande idea.

Per noi una porta è molto più di un pezzo di legno o di vetro: vi aspettiamo a scoprire VillaRe.

VillaRe is an Italian high quality brand in door design.

Opened a few years ago, Villare production sells doors by nationwide retailers and further.

Our design is also appreciated in foreign countries and the Italian quality is an incomparable surplus.

Villare aims at innovation and evolution while respecting nature and choosing high quality materials. Door is interpreted like an object of design that enhances every room.

Our expert staff and our artisans can exalt all products qualities and they know how to take care of details.

We are constantly studying new solutions and we can come true what it seems only a dream.

Not just a piece of wood or glass, in our mind door is more.

We invite you to discover Villare collection.

INDICE

sistemi di apertura	<i>pag.</i>	6
caratteristiche anta	<i>pag.</i>	8
caratteristiche stipite	<i>pag.</i>	10
cerniere a scomparsa		
WOOD - laccata liscia	<i>pag.</i>	16
FILO - laccata liscia con apertura filo esterno a spingere	<i>pag.</i>	20
FIGURA - laccata con pantografatura squadrata a scalino singolo	<i>pag.</i>	24
KAPI - laccata con pantografatura squadrata a doppio scalino	<i>pag.</i>	30
VELASCA - laccata con pantografatura a scivolo	<i>pag.</i>	36
SPATIO - laccata con pantografatura sfumata	<i>pag.</i>	40
GEO - laccata con incisioni e svuotature geometriche	<i>pag.</i>	46
FLOS - laccata con pantografatura floreale	<i>pag.</i>	54
FRAME - laccata con incisione a cornice	<i>pag.</i>	60
HEX - laccata con pantografatura esagonale	<i>pag.</i>	64
TABULA - laccata con incisione personalizzata da tavola	<i>pag.</i>	68
SERVICE - laccata con incisioni di servizio	<i>pag.</i>	72
HIDE - sintetica scavata con finiture effetto legno	<i>pag.</i>	76
VELO - sintetica a tinta unita	<i>pag.</i>	86
cerniere anuba		
LAC - laccata liscia	<i>pag.</i>	98
SETAN - laccata pantografata classica	<i>pag.</i>	102
TOFI - laccata doppia pantografatura classica	<i>pag.</i>	108
RELIEF - laccata pantografata con cornici classica	<i>pag.</i>	114
LINEAR - laccata incisa	<i>pag.</i>	118
PANDORA + - sintetica scavata	<i>pag.</i>	124
PANDORA - sintetica liscia	<i>pag.</i>	132
DICIANNOVE - sintetica	<i>pag.</i>	138
LEXI - sintetica liscia - telaio tondo	<i>pag.</i>	144
sistema vetro	<i>pag.</i>	150
sistema inserti	<i>pag.</i>	152
sistema boiserie	<i>pag.</i>	156
maniglie	<i>pag.</i>	158
finiture	<i>pag.</i>	160
mani d'apertura	<i>pag.</i>	162

DISPONIBILITA'

AVAILABILITY



VillaRe, oltre a realizzare prodotti di eccellenza italiana, offre anche servizi utili che accompagnano la realizzazione delle porte e la loro vendita.

Il magazzino pronta consegna è uno di questi servizi: grazie al grande magazzino di cui VillaRe dispone, i pezzi standard sono sempre presenti e pronti per essere consegnati. In questo modo VillaRe elimina i tempi di attesa, fastidiosi quando si tratta di piccoli pezzi, ed è in grado di andare incontro alle esigenze dei suoi clienti in modo personalizzato.

In addition to produce high quality Italian doors, Viilare offers some services linked to door production and selling.

Our key is prompt delivery: thanks to our big storehouse, standard doors are always available and ready to be delivered. This way Villare eliminates all waiting time and meets every customer's requirements.

CUORE E PASSIONE

HEART AND PASSION



Oltre al magazzino, nella produzione VillaRe c'è una falegnameria interna, con artigiani esperti pronti a realizzare le modifiche necessarie, a gestire i fuori misura e a rispondere alle richieste personalizzate.

In questo modo VillaRe può seguire i suoi clienti sotto ogni aspetto e nei dettagli, offrendo un prodotto di altissima qualità con un servizio impeccabile.

Villare has an internal carpentry and our artisans are able to customize or modify doors according to every customer's needs and tastes.

This way Villare gives both a high quality product and an excellent service.

TECNOLOGIA

TECNOLOGY



La tecnologia e il futuro sono il presente che VillaRe vuole incarnare.

Cerniere a scomparsa, sistemi d'apertura, serrature magnetiche e materiali innovativi sono i capi saldi di una produzione improntata ad ottenere la miglior tecnologia possibile per renderla disponibile a chiunque.

Technology and future are the present that Villare wants to be.

Here are the keys of the new collection : concealed hinges, different door openings, magnetic locks and innovative materials.

The best technology becomes affordable for everyone.

SUPPORTO

SUPPORT



I professionisti di VillaRe sono sempre pronti a rispondere alle richieste, anche quando si tratta di trovare la soluzione migliore per una porta.

La consulenza e il supporto fanno parte dei servizi che VillaRe offre sulla sua produzione di porte: l'azienda è disponibile via telefono o email, per trasmettere anche in questo modo la filosofia e la qualità che stanno dietro al marchio VillaRe.

Our experts are always available to meet every customer's requirements and find the best solution for you.

We also provide professional advice and technical assistance by mail or by phone. This way we transmit Villare brand qualities and philosophy.

SISTEMI DI APERTURA OPENINGS SYSTEM

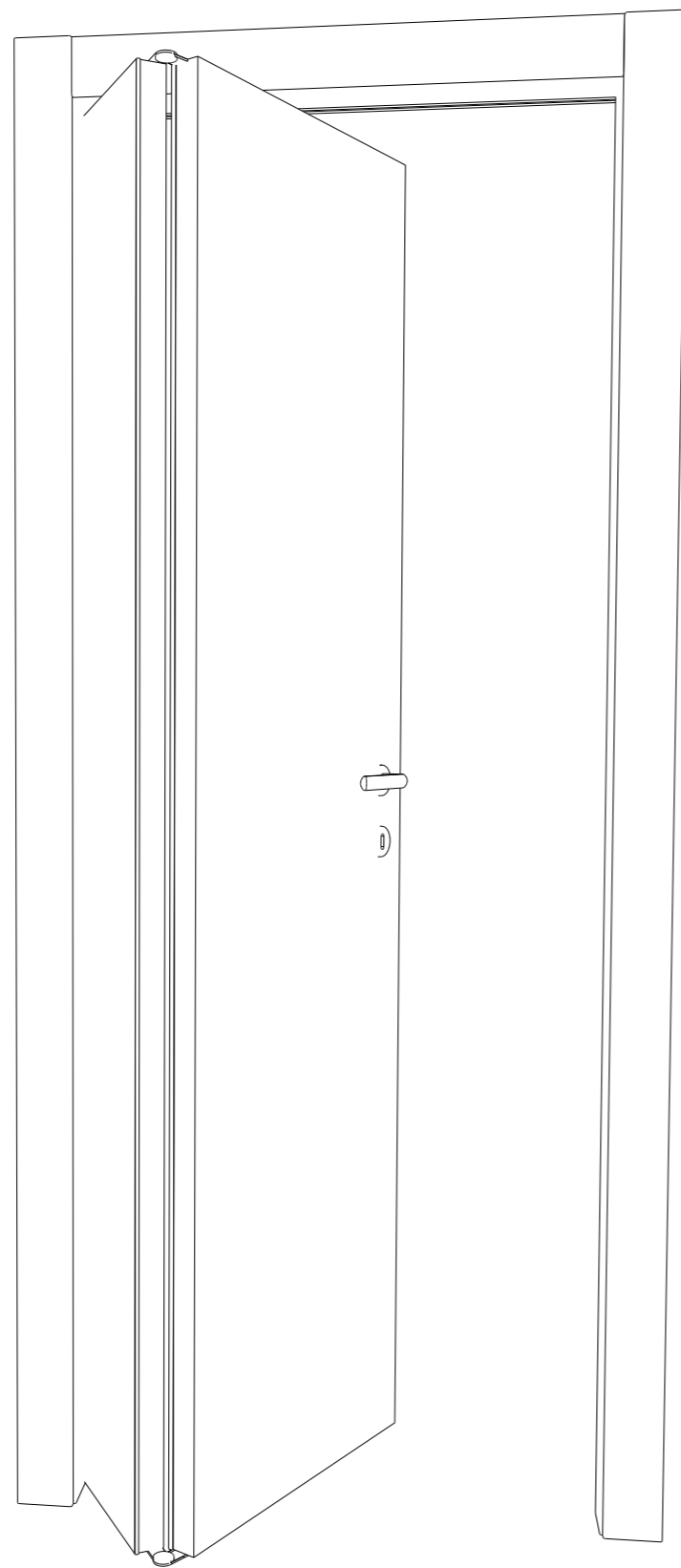

la scelta

la possibilità di scegliere un sistema di apertura adeguato alle proprie esigenze, determina la comodità nell'utilizzo della porta nella vita di tutti i giorni.

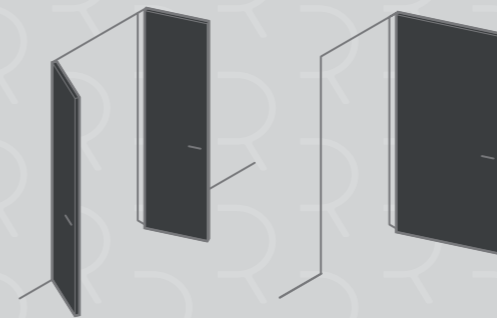

BATTENTE

- apertura tradizionale
- realizzabile ad una o due ante
- soluzione con maggiore abbattimento acustico



FILO

- apertura a filo esterno a spingere
- montaggio semplificato
- design filomuro con coprifili

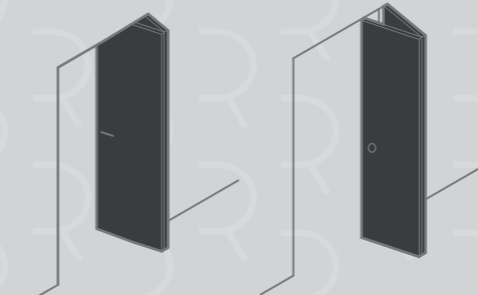

LIBRO, META' O PIEGHEVOLE

- 2 ante uguali o asimmetriche che si piegano
- ideale per chiudere spazi ridotti
- minimo ingombro



ROTOTRASLANTE

- apribile in entrambe le direzioni
- soluzione innovativa
- facilità di passaggio

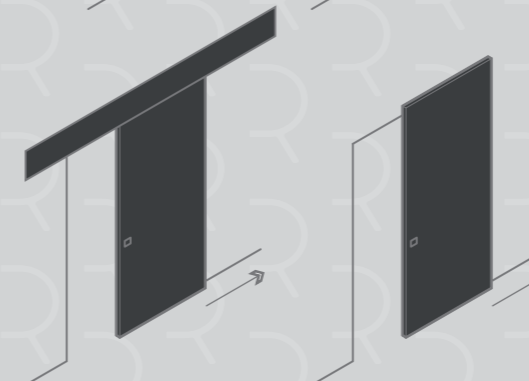

MAGIC O SCORREVOLE ESTERNO MURO

- esclude lavori di muratura
- elemento d'arredo
- disponibile a una o due ante

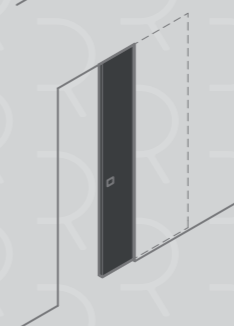

SCORREVOLE INTERNO MURO

- ideale per problemi spazio ridotto
- lascia libera la parete
- elimina l'ingombro dell'anta nella stanza

la struttura

una struttura in abete permette una migliore stabilità dell'anta, per non trovarsi brutte sorprese nell'arco della vita di una porta.

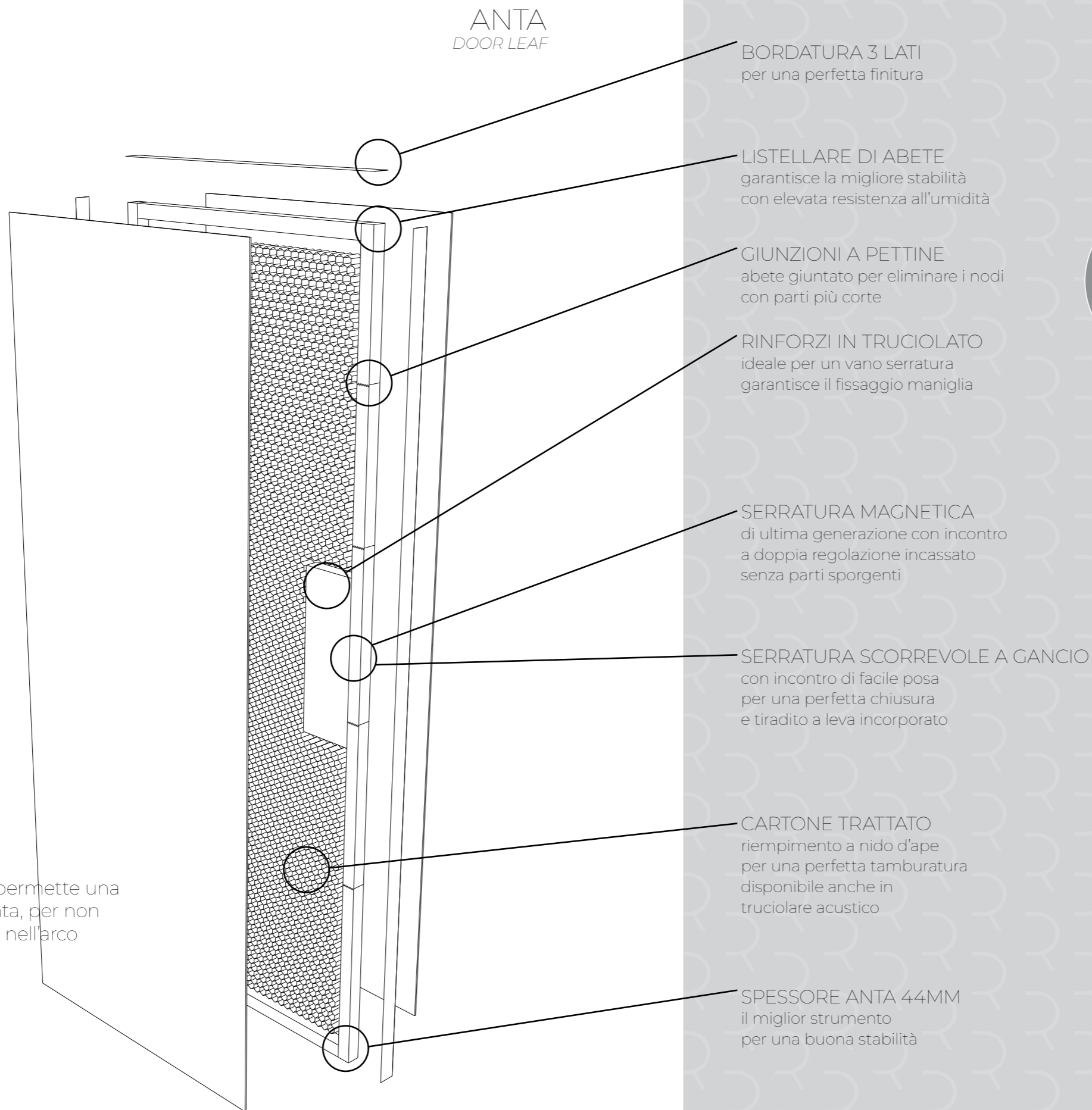

RESISTENZA ALL' UMIDITA'
struttura in abete struttura in MDF

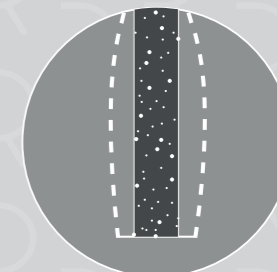

contropiastra regolabile



contropiastra



chiave patent



WC doppio quadro



yale

STIPITE DOOR JAMB

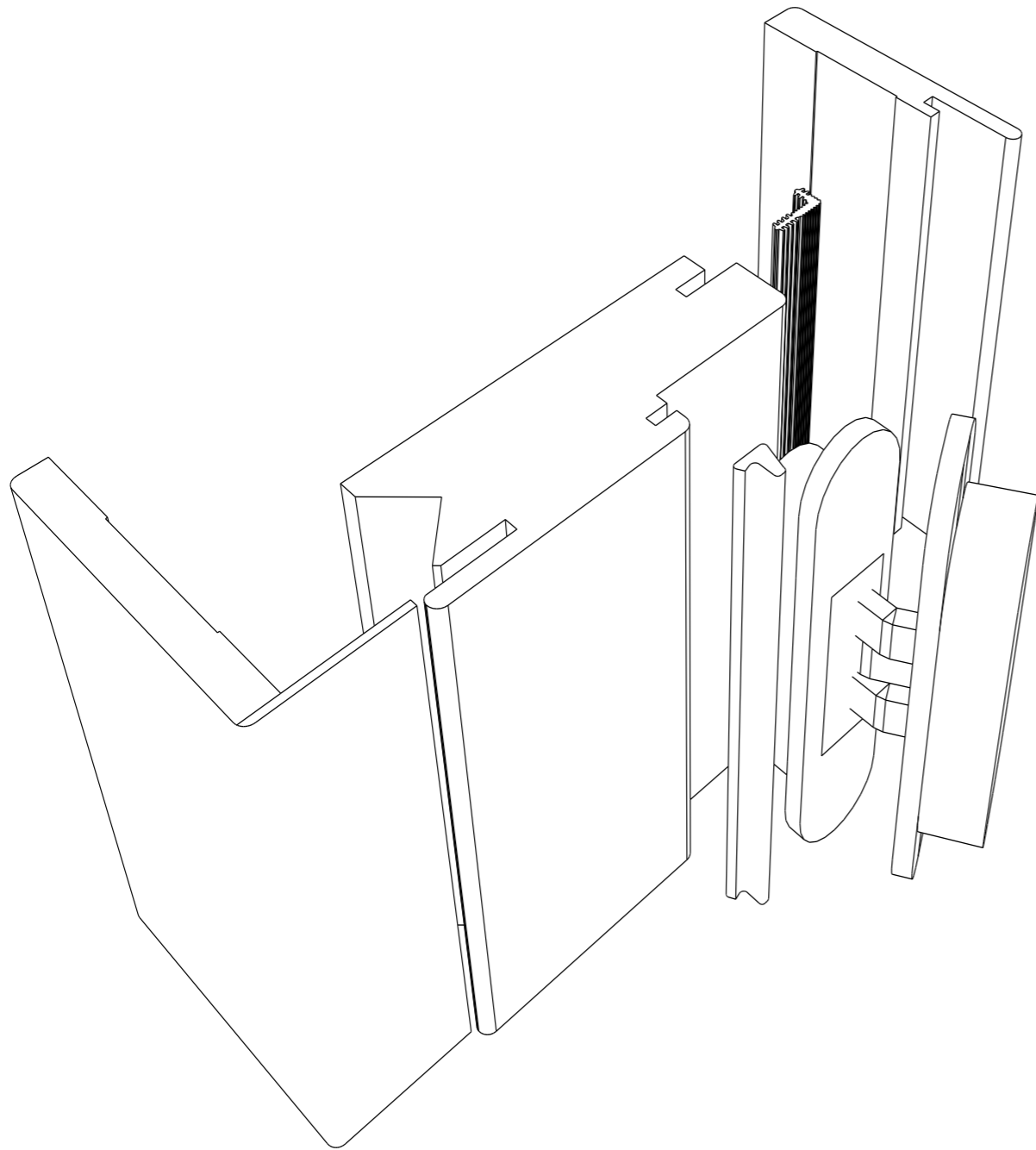

per ogni stile

la versatilità dei telai VillaRe
permette di creare ogni
stile, classico e moderno

cerniere a Scomparsa

FILO

telaio in legno raggio 3
cerniere regolabili 3D
finitura bianca o argento
apertura a 90°
complanarità esterna
anta con 3 battute
coprifili estensibili lato interno
coprifilo esterno a innesto frontale
piastra di montaggio in battuta
disponibile in laccato, sintetico opaco e
sintetico scavato

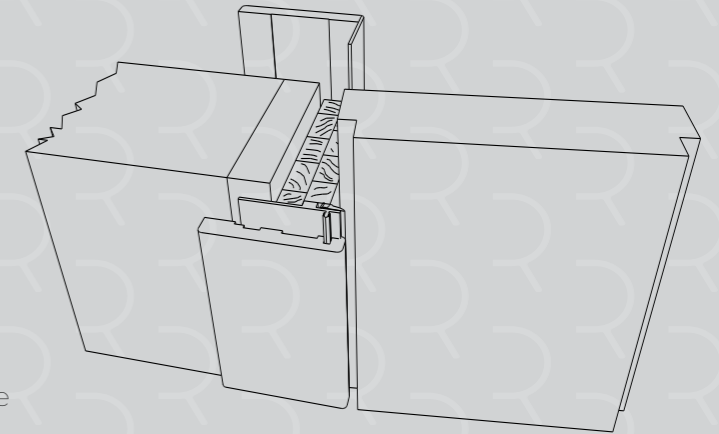

MINIMALE

telaio in legno raggio 3
cerniere regolabili 3D
finitura bianca o argento
apertura a 180°
complanarità interna
anta senza battute
reversibilità senza ribaltamento
coprifili estensibili lato esterno
coprifilo interno a innesto frontale
disponibile laccato, sintetico opaco e
sintetico scavato

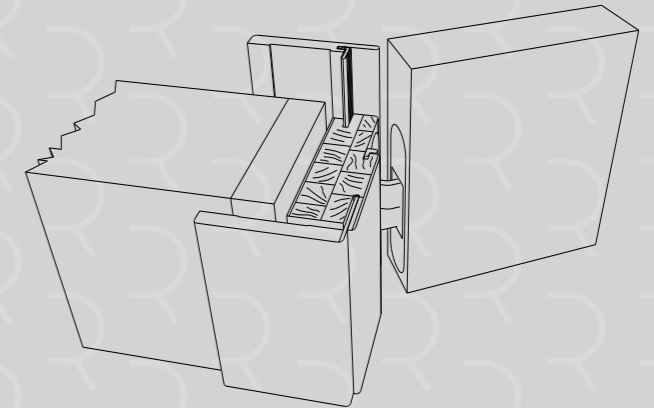

cerniere Anuba

MODERNO

telaio raggio 3
3 strati con anima in legno
cerniere 3 anuba regolabili su 2 assi
apertura 150°
finitura zincata o ottone
coprifili estensibili su 2 lati
da 85mm esterni e 65mm interni
battuta su 3 lati
disponibile laccato, sintetico opaco e
sintetico scavato

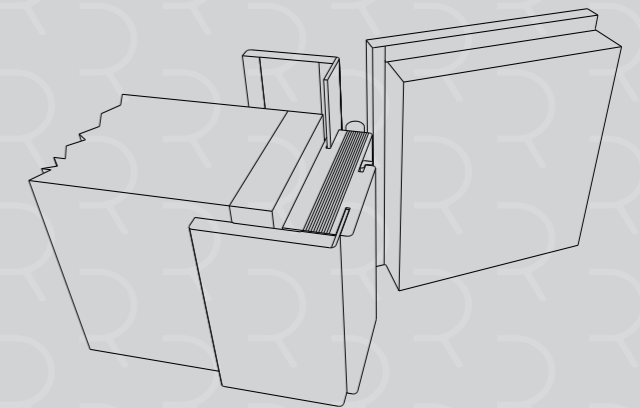

CLASSICO

telaio raggio 50
3 strati con anima in legno
cerniere 3 anuba regolabili su 2 assi
apertura 150°
finitura zincata o ottone
coprifili estensibili su 2 lati da 70mm
coprifilo trasverso piatto
battuta su 3 lati
disponibile sintetico opaco

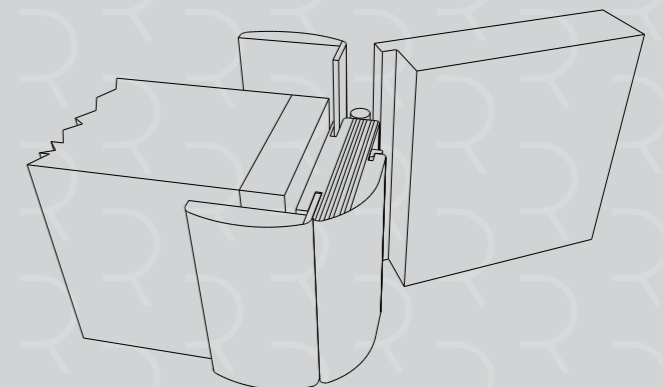

LA COLLEZIONE
COLLECTION

cerniere a Scomparsa *Hidden hinges*

caratteristiche

Porta **Reversibile** complanare interno con ferramenta cromo satinata

Anta da 44 mm **senza battuta**

Anta con telaio perimetrale in abete ed interno in nido d'ape,
disponibile a richiesta con truciolare forato

Finiture in laccato, frassino scavato, sintetiche scavate e sintetiche opaco

Serratura **magnetica** con foro chiave

Cerniere invisibili regolabili sui tre assi

Stipite in **legno piatto** con guarnizione in schiuma telata

Coprifili in multistrato da 80mm telescopici su un lato

*Reversible Door with internal co-planarity and chrome satin hardware
44 mm leaf thickness without door stop*

*Hollow core panel with finger-joint perimeter and inner honeycomb structure
also available with perforated acoustic hardboard structure*

Laquered, brushed laquered, brushed laminate and matt laminate finishes

Magnetic lock with key hole

3 dimensions adjustable hidden hinges

Solid wood jamb with foam seal

One side multilayer telescopic casing, 80mm width



TELAIO E CERNIERE FRAME AND HINGES



Cerniere a scomparsa regolabili sui 3 assi di serie, con finitura Bianca o Argento e coperture con apertura a 180°.
Hidden 3 dimensions adjustable hinges in white or silver finishing 180° opening.



Telaio in legno massiccio per stabilità e qualità. Coprifili da 8 cm, complanari nel lato interno ed estensibili nel lato esterno, per esteticità, formano il sistema perfetto per ogni tipo di muratura.
Solid wood jamb confers stability and quality. 8 cm casing, inner side coplanarity and outer side extensibility, create the perfect system for every kind of wall.

COMPLANARE E REVERSIBILE CO-PLANARITY AND REVERSIBILITY

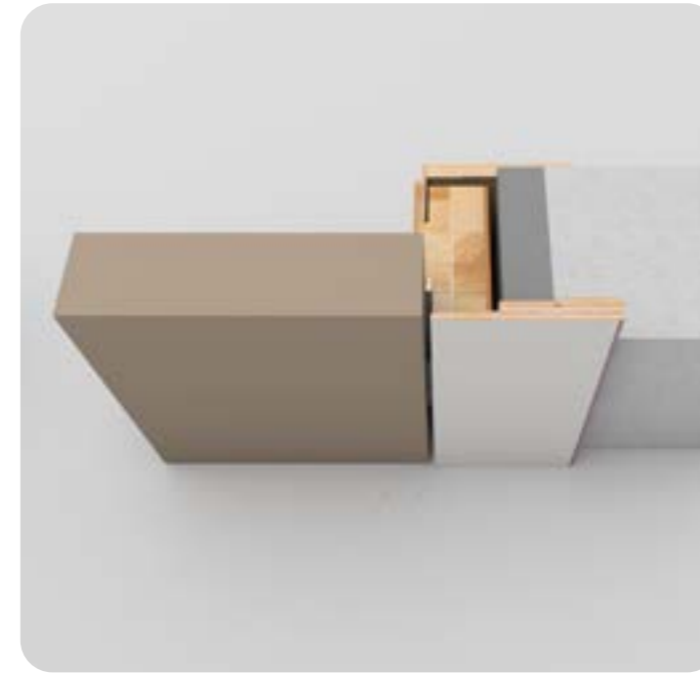

Complanarità sul lato interno o esterno della stanza, anta e coprifilo saranno tutti sullo stesso piano. Il traverso superiore del coprifilo sarà rientrante rispetto ai montanti per permettere una completa finitura dei coprifili.
Co-planarity inside or outside the room, shutter and casing are on the same level. Top casing curves inwards compared to lateral casing to avoid a complete finishing.

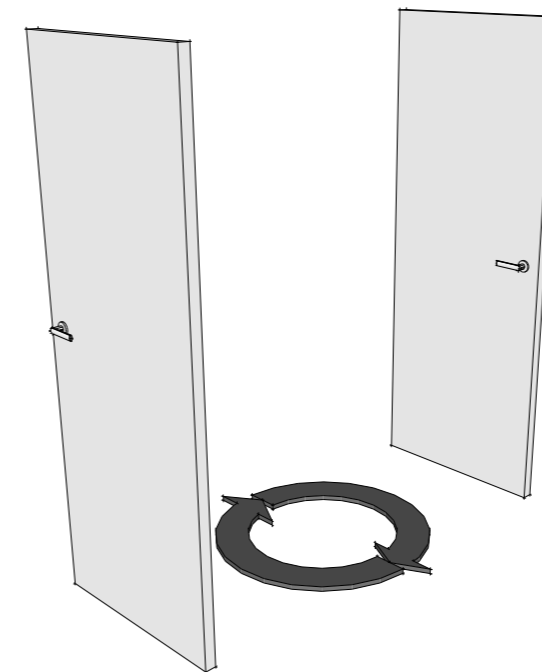

Reversibilità della porta senza ribaltamento dell'anta. Fino all'ultimo momento potrete decidere la mano d'apertura della porta.
Reversible door without overturning of leaf. Thus you can change door opening direction at any time.

Wood
mod. A
laccato Bianco
apertura a battente

laccata liscia
cerniere a scomparsa

Wood

Wood



Wood
mod. 2PC con inserti argento
laccato RAL
apertura a battente
e Magic a vista

Filo
mod. finestrata a disegno
con fermavetri a filo
laccato ghiaccio
apertura a filo esterno a spingere



Filo
mod. 2VNP
laccato ghiaccio
apertura a filo esterno a spingere



laccata liscia apertura dal filo esterno
cerniere a scomparsa

Filo



Fermavetro a filo

Filo
mod. A
laccato bianco
apertura a Filo esterno a spingere

Figura
mod. 1
laccato RAL
apertura a filo

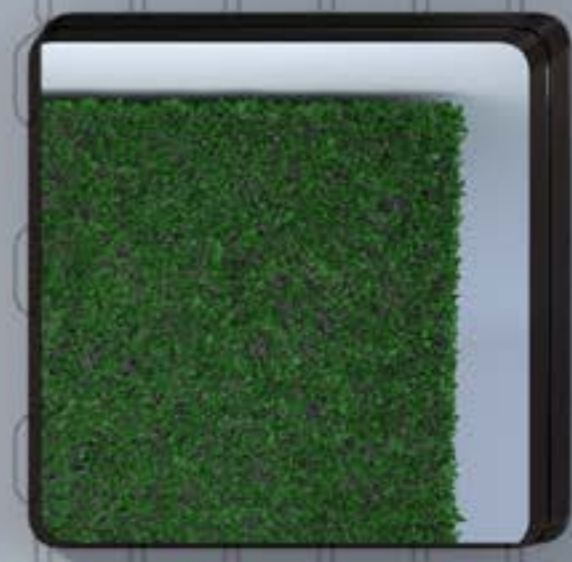

laccata pantografata spigolo vivo
cerniere a scomparsa

Figura



Figura
mod. 3
laccato bianco
apertura rototraslante



Figura 1



Figura 2



Figura 2a



Figura 2b



Figura 4



Figura 6



Figura 7



Figura 8



Figura 9



Figura 11



Figura 12



Figura 15



Figura 16



Figura 17



Figura 22



Kapi
mod. 2
laccato bianco
apertura a battente

laccata pantografata doppio scalino
cerniere a scomparsa

Kapi

Kapi

Kapi con Boiserie
mod. 3
laccato RAL
apertura a battente

La pantografatura squadrata su 3 livelli con angoli a 90°, può essere corredata da inserti in finitura cromo satinata e cerniere invisibili regolabili sui 3 assi.

L'insieme classico e moderno fa nascere Kapi.





Kapi 1



Kapi 2



Kapi 3



Kapi 7



Kapi 9



Kapi 16



Kapi 22



Velasca
mod. 12
laccato bianco
apertura a battente

laccata pantografata a scivolo
cerniere a scomparsa

Velasca



Velasca 1



Velasca 2



Velasca 3



Velasca 7



Velasca 12



Velasca 16



Velasca 22



Spatio
mod. S
laccato sabbia
apertura a battente



laccata pantografatura sfumata
cerniere a scomparsa

Spatio



Una nuova pantografatura, una firma e un taglio nello spazio lineare della porta.

Spatio
mod. E
laccato bianco
apertura a battente



Spatio E



Spatio F



Spatio G



Spatio O



Spatio S



Spatio T



Spatio V



Spatio W



Spatio X

Geo
mod. L4
laccato Terra
apertura a battente

laccata incisioni e svuotature geometriche
cerniere a scomparsa

Geo

Geo

Geo
mod. F1 - C1
laccato RAL
apertura a battente



Geo

Geo
mod. M2
laccato bianco
apertura Magic senza piastra





Geo B1



Geo B2



Geo B3



Geo B4

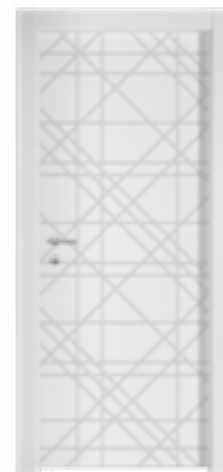

Geo L1



Geo L2



Geo L3



Geo L4

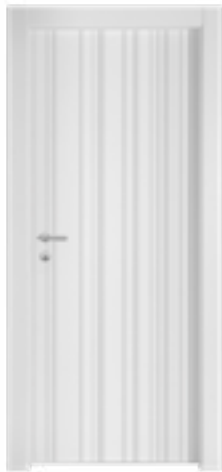

Geo B5



Geo C1



Geo C2



Geo C3



Geo L5



Geo L6



Geo M1

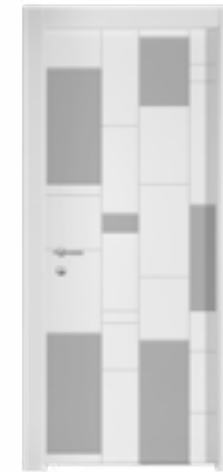

Geo M2



Geo C4



Geo C5



Geo C6



Geo F1



Geo M3



Geo M4



Geo M5



Geo M6



Geo F2



Geo F3



Geo F4

Flos
mod. 2
laccato RAL
apertura battente

laccata con pantografature floreali
cerniere a scomparsa

Flos



Flos

Una pantografatura realizzata con
particolari in incisoria.
Il livello del dettaglio fa di Flos una
porta raffinata ed elegante.

Flos
mod. 5
laccato ghiaccio
apertura battente



Flos
mod. 6
laccato bianco
particolare



Fros 1



Fros 2



Fros 3



Fros 4



Fros 5



Fros 6



Fros 7



Fros 8



Frame
mod. 6V
laccato ghiaccio
apertura battente

laccata incisioni decorative
cerniere a scomparsa

Frame



Frame 1A



Frame 1B



Frame 1C



Frame 1V



Frame 5A



Frame 5B



Frame 5C



Frame 5V



Frame 3A



Frame 3B



Frame 3C



Frame 3V



Frame 6A



Frame 6B



Frame 6C



Frame 6V



Hex
mod. 8
laccato SuperMatt
apertura scorrevole Eclettica

laccata pantografatura esagonale
cerniere a scomparsa

Hex

Hex
mod. 6
laccato bianco
particolare



Hex 1



Hex 2



Hex 3



Hex 4



Hex 5



Hex 6



Hex 7



Hex 8

Tabula
mod. a disegno
laccato RAL
apertura Magic incasso

laccata incisione personalizzabile
apertura dal filo esterno

Tabula

una porta
personalizzata
per te
scegli quale
parte della
tavola
diventera' la tua
porta unica





Service
mod. L W
laccato NCS
apertura battente

Service
mod. L M
laccato NCS
apertura battente

laccata con incisioni di servizio
cerniere a scomparsa

Service



Service
mod. C W
laccato RAL nero con coprifilo NCS
apertura battente

Taglia

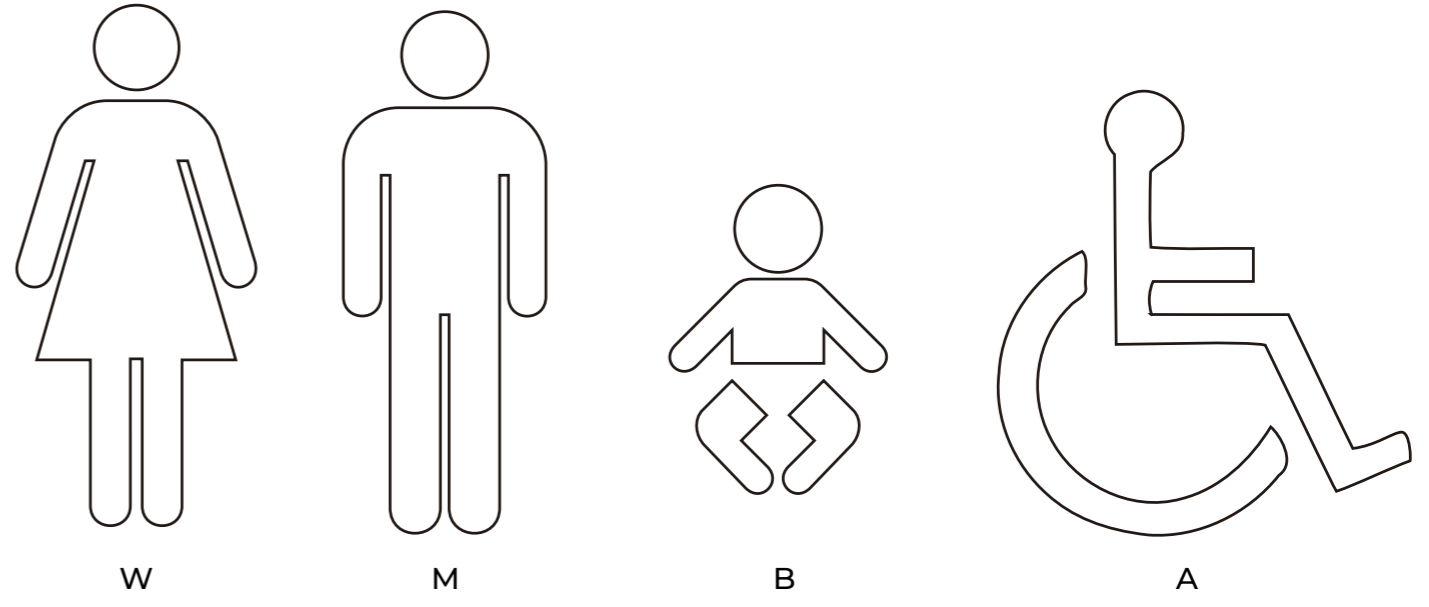
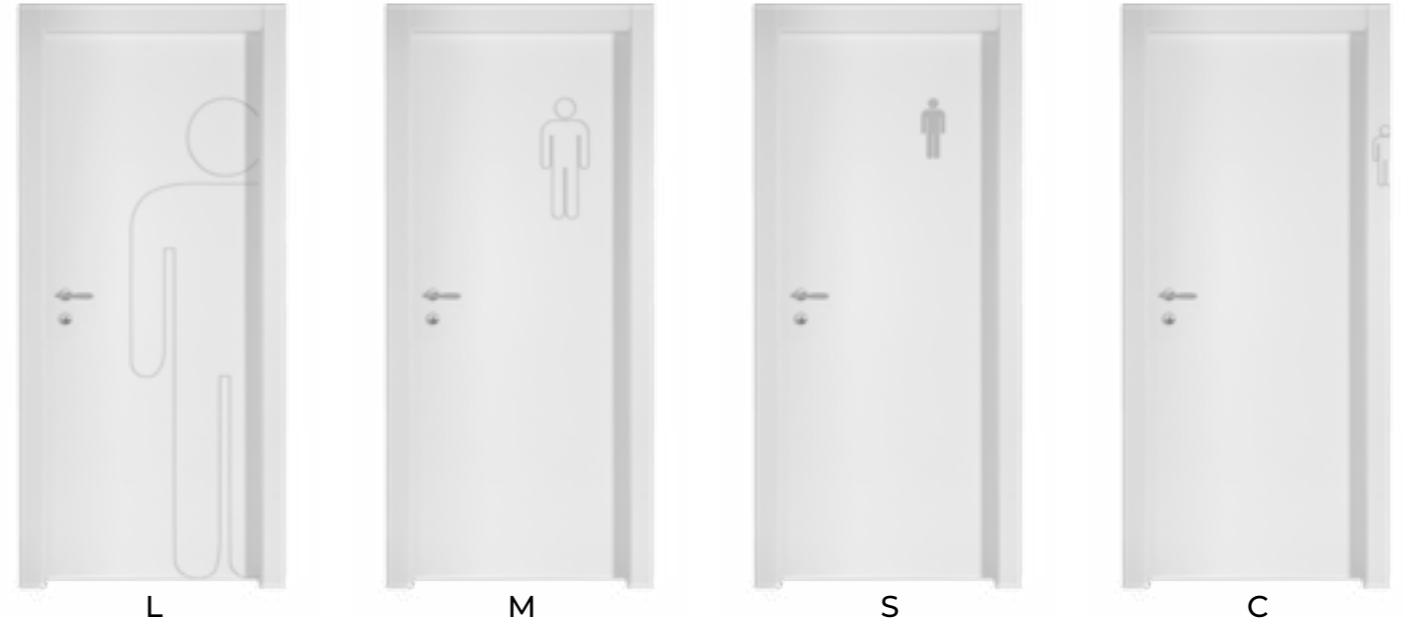

Modelli

Hide
mod. Luce
rosewood
apertura battente

Hide
mod. 2VPL con inserti argento
rosewood
apertura battente

finiture sintetiche scavate
cerniere a scomparsa

Hide

Hide

Moderna e naturale in Mirò, azimut, matrix, rosewood, noce leuca e naturale, questa porta ha delle linee uniche, squadrate che danno un'idea di design nuovo, pulito e semplice nella sua complessità.



Hide
mod. Luce
rosewood
apertura battente



Hide
mod. A
rosewood
apertura battente

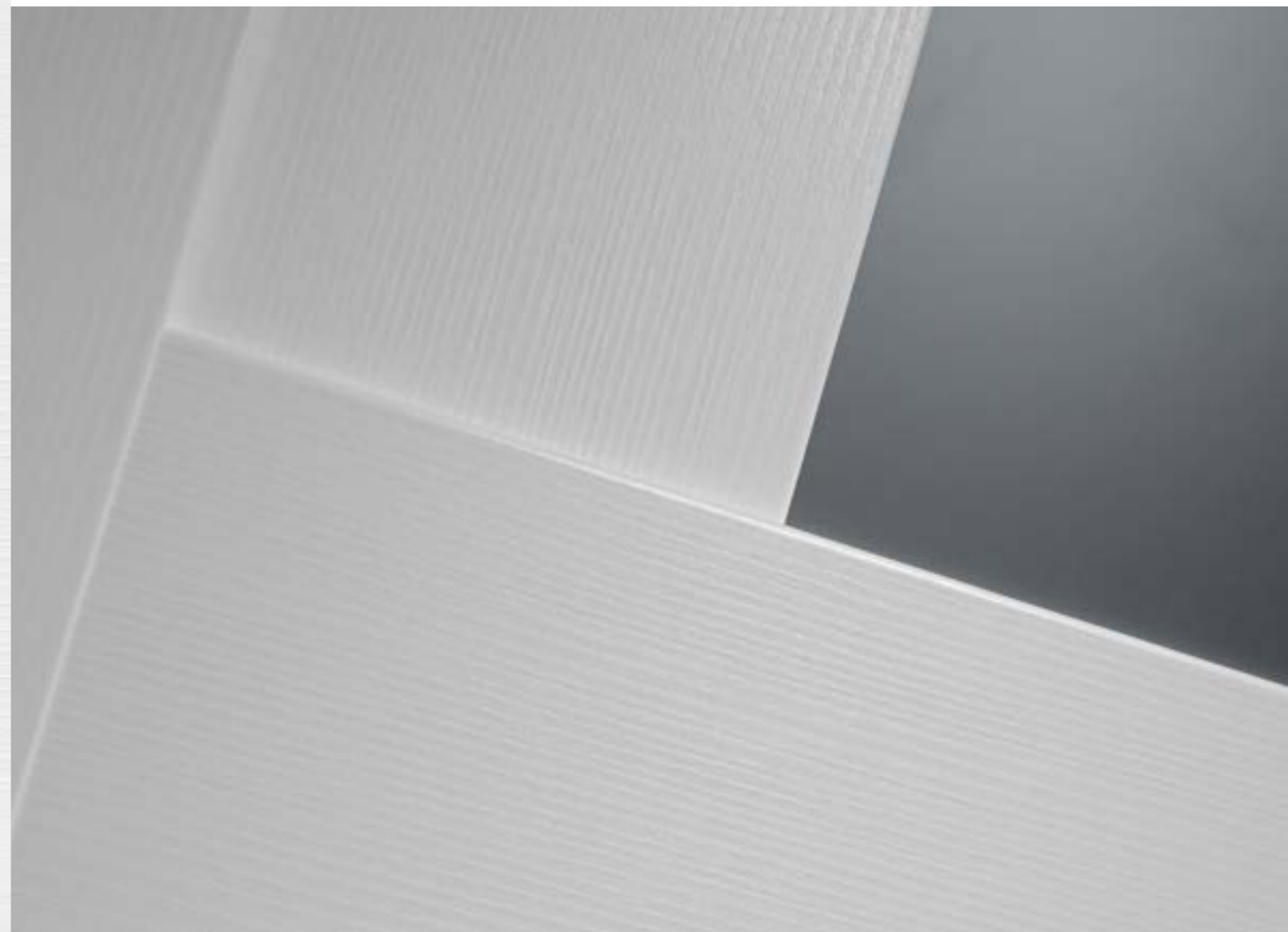

particolare Miro' bianco

La serratura si distingue per straordinaria silenziosità in chiusura, precisione negli accoppiamenti meccanici che trasmettono una piacevole sensazione di fluidità dei movimenti alla maniglia e alla chiave.

particolare Naturale finitura Matrix



Hide
mod. 1VP
naturale
apertura battente



Hide
mod. 12 inserti oro
noce leuca
apertura battente

Inserti in alluminio pieno vengono inseriti a mano dopo aver creato l'apposita fresatura tramite pantografi regolati al decimo di millimetro. Gli inserti anodizzati vengono anche forniti in differenti colorazioni.

Velo
mod. A
bianco
apertura battente

Velo
mod. A
bianco
apertura Magic a vista

finiture sintetiche tinta unita
cerniere a scomparsa

Velo

Velo



particolare Azimut ghiaccio

Velo



Velo
mod. A
sabbia
apertura battente

Velo

Velo
mod. A
Azimut terra
apertura battente a due ante



particolare Azimut terra

Velo

Velo
mod. A
Bianco
apertura battente



LA COLLEZIONE
COLLECTION

cerniere Anuba *Anuba hinges*

caratteristiche

Porta con ferramenta cromo satinato / ottone lucido.

Anta da 44 mm **con battuta**.

Anta con telaio perimetrale in abete ed interno in nido d'ape.

Finiture in laccato, laccato scavato, sintetico scavato e sintetico opaco.

Serratura magnetica con foro chiave.

Cerniere **Anuba**.

Stipite **piatto** R3 in **panino** di legno e MDF con guarnizione in schiuma telata.

Coprifili piatti telescopici da 65 mm e da 85 mm.

Door with chrome satin / polished brass hardware.

44 mm leaf thickness.

Hollow core panel with finger-joint perimeter and inner honeycomb structure.

Laquered, brushed laquered, brushed laminate and matt laminate finishes.

Magnetic lock with key hole.

Anuba hinges.

Plane frame with multi-layered core and MDF cover with foam seal.

Two sides telescopic casing, 85mm and 65mm width.



APERTURA E ANUBA OPENINGS AND HINGES



Cerniere anuba, le più affidabili, in finitura zincata o ottonata, regolabili su 2 assi con apertura a 150°.

Anuba hinges, the most reliable, in galvanized or brass finishes, adjustable on 2 axes. 150° opening



Flessibilità di telaio. I coprifili vengono forniti di serie con delle lunghe alette, per potersi adattare a molti spessori muro.

Frame flexibility. Casings have long expanding wings, ideal to various wall thickness.

BATTUTE E ANTA DOOR STOP AND SASH

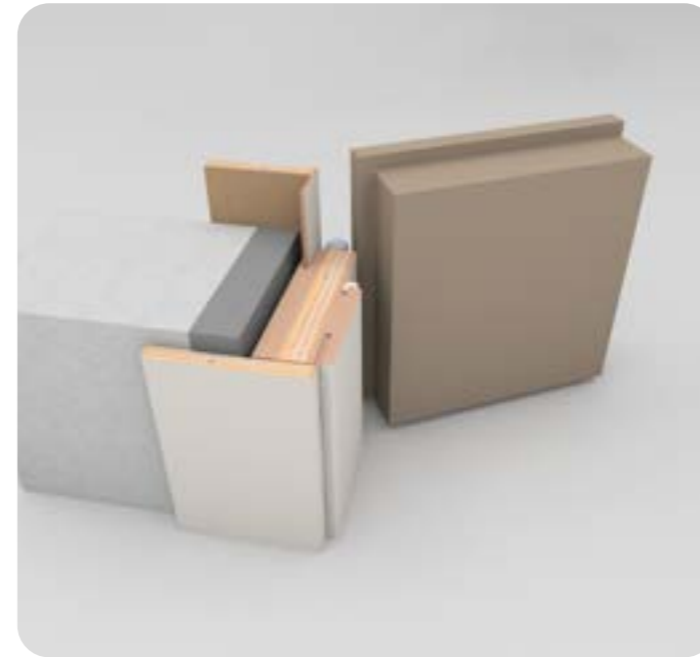

Battute sui lati per una perfetta chiusura ed un montaggio più semplice.

Sides door stop, both on sides and top, for a perfect closing and easy installation.

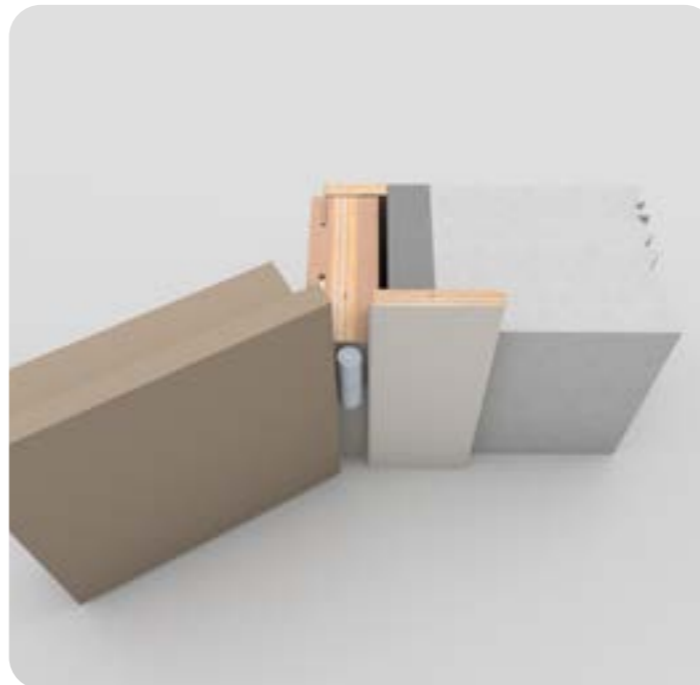

Telaio con anima in multistrato di pioppo, ideale per la stabilità delle cerniere, MDF superficiale per una perfetta finitura.

Solid wood jamb with MDF confers stability and quality. MDF casings for a better resistance.

Lac
mod. A
laccato bianco
apertura battente



laccata liscia
cerniere anuba

Lac

particolare apertura a libro



Lac
mod. A
laccato bianco
apertura scorrevole interno muro

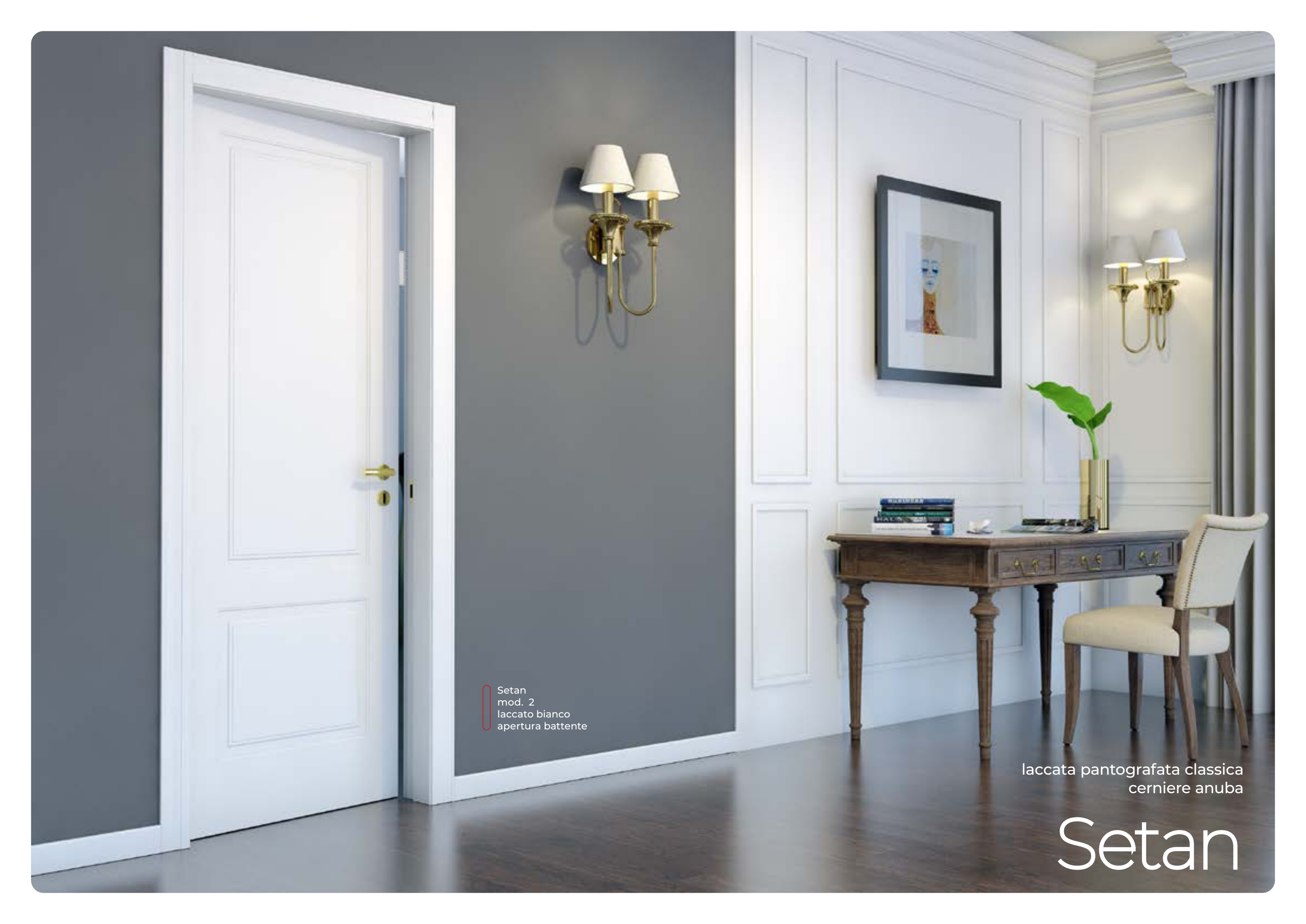

Setan
mod. 2
laccato bianco
apertura battente

laccata pantografata classica
cerniere anuba

Setan



La superficie opaca, la pantografatura sagomata, il telaio moderno, fanno della porta Setan un esempio del design VillaRe, forte nella sua semplicità, nei dettagli e nella propensione al creare.

Setan con boiserie
mod. 7
laccato patinato con foglia argento
apertura due battenti



Setan 1



Setan 2



Setan 3



Setan 4



Setan 5



Setan 6



Setan 7



Setan 8



Setan 9



Setan 10



Setan 11



Setan 12



Setan 13



Setan 14



Setan 15



Setan 16



Setan 19



Setan 20



Setan 21



Setan 22





Tofi
mod. 22 con coprifilo sagomato
laccato bianco
apertura battente a 2 ante

laccata doppia pantografatura classica
cerniere anuba

Tofi



Tofi
mod. 1 con coprifilo sagomato
laccato RAL
apertura battente



Tofi 1



Tofi 2



Tofi 3



Tofi 4



Tofi 5



Tofi 6



Tofi 8



Tofi 9



Tofi 15



Tofi 22





Relief
mod. 2
laccato bianco
battente con boiserie

laccata pantografata con cornici
cerniere anuba

Relief



Relief 1



Relief 2



Relief 9



Relief 15



Relief 22





Linear
mod. 12 a disegno
laccato bianco
apertura battente

laccata incisa a V
cerniere anuba

Linear



Linear
mod. 7
laccato RAL
apertura battente



Linear 1



Linear 2a



Linear 2b



Linear 3



Linear 4



Linear 5



Linear 6



Linear 7



Linear 8



Linear 9



Linear 10



Linear 11



Linear 12 (a disegno)



Linear 13



Linear M



Linear 21



Linear 22



Linear P2



Linear D2



Linear S2





Pandora +
mod. A
palissandro
apertura battente

finiture sintetiche scavate
cerniere anuba

Pandora+

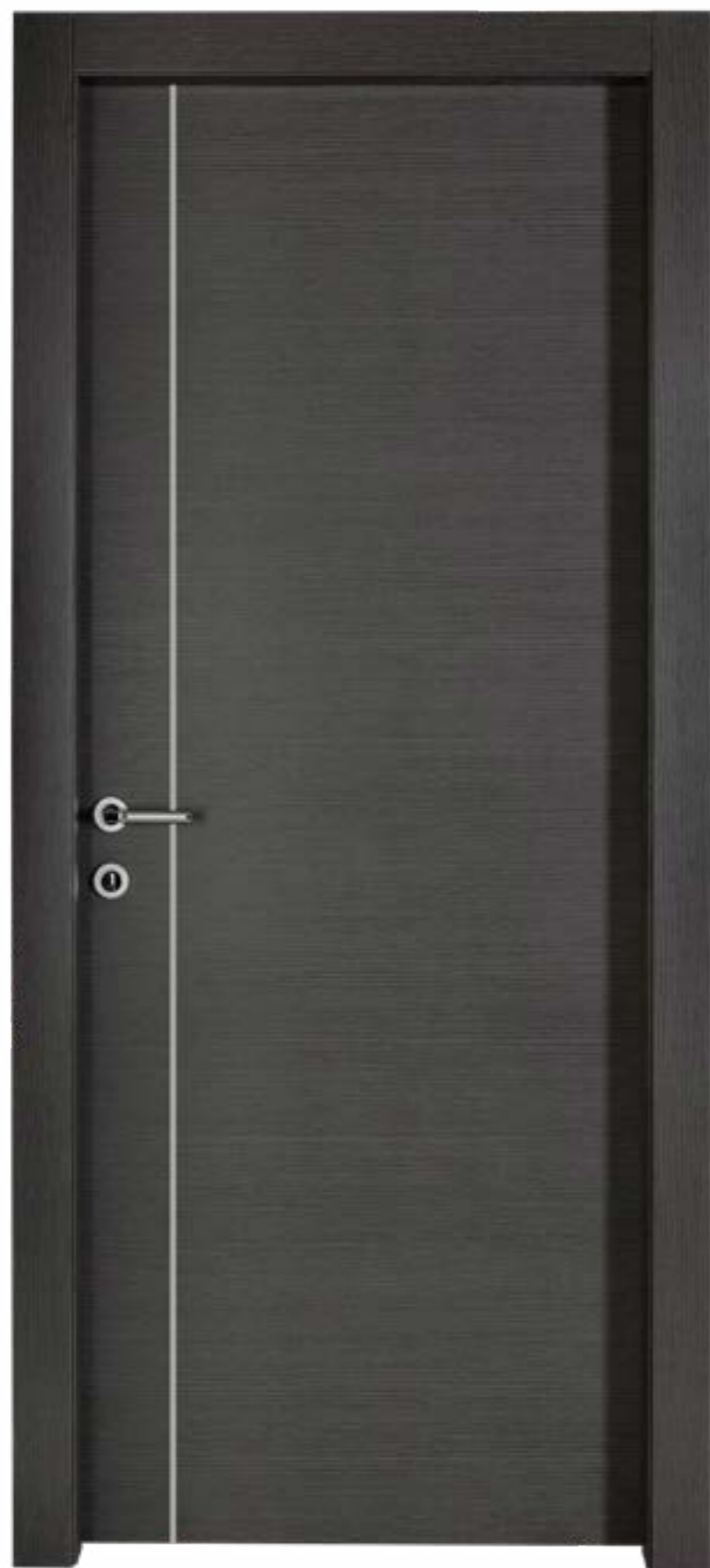

Pandora +
mod. 1VP
antracite
apertura battente

La completezza nei tipi di aperture offre la possibilità di abbinare a qualsiasi esigenza, la finitura desiderata e la sua apertura. Porta pieghevole e Rototraslante sono le ultime arrivate in un mondo in evoluzione.

particolare antracite





Pandora +
mod. A
marbella
apertura battente



particolare marbella

Pandora con quel tocco in più: è la linea Pandora Più nelle sue declinazioni interessanti e sofisticate. Un'eleganza che non passa certo inosservata abbinata alle finiture più moderne.



Pandora +
mod. A
matrix bianco
apertura battente



particolare matrix avorio



Pandora
mod. finestrata a disegno con fermavetri a filo
noce nazionale
apertura scorrevole esterno muro 2 ante

finiture sintetiche opache e poro
cerniere anuba

Pandora

Pandora

Serratura a gancio per scorrevole e cerniere anuba in finitura cromo satinata sono il punto di partenza per VillaRe.

Perchè ogni nostro prodotto viene progettato con la massima attenzione al particolare.



Pandora
mod. A
bianco
apertura battente

Pandora

Pandora è la porta nuova che non si può fare a meno di notare. Moderna, dal design pulito e classico in alcune declinazioni, questa linea esalta i dettagli.



Pandora Pieghevole
Rovere orizzontale





Diciannove
mod. A
noce bianco
apertura battente

finiture sintetiche
cerniere anuba

Diciannove



Diciannove
mod. A
noce grigio
apertura battente





finitura
noce bianco



finitura
noce grigio



Lexi
mod. A
bianco
apertura battente

finiture sintetiche opache e poro
telaio tondo cerniere anuba

Lexi



Lexi
mod. A
noce nazionale
apertura battente



Lexi
mod. B
rovere sbiancato orizz.
apertura battente

particolare telaio Lexi tondo
noce biondo



Lexi
mod. A
noce antico
apertura a libro



Modelli Vetro / Glass Models
 Modelli / Models



mod B
 finestratura standard e
 fermavetri in rilievo



finestrata a disegno
 o con fermavetro a
 filo



Tuttovetro



13-4V



Luce



Wood
 mod. TuttoVetro
 laccato bianco
 apertura a battente

Sistema Vetro
 Glass System

:colori disponibili



Argento / Silver



Bronzo / Bronze



Oro / Gold



Arancio / Orange



ROSSO / Red



Verde / Green



Blu / Blue



Nero / Black



Velo
mod. Spiga inserto nero
ghiaccio
apertura a battente

Sistema Inserti
Inserts System

Inserti



1P



2PC



2P



3P

Classic



4P



1NP



2NPC



2NP



3NP



4NP



1VP



2VPL



4VP



1VNP



2VNP



1NP DX-SX



TNP



XNP



FLESSA



NOVANTA

Zero45



11



12



13



21



22

Art



SPIGA



SEGMENTI



TRACCE



BANDIERA



AUTUNNO



PRIMAVERA



ESTATE



INVERNO



CORIANDOLI



ALTROVE



PIOGGIA



TRAMONTO



PARIGI



PISA



DUOMO

PANNELLO
il corpo del progetto

LESENA
il suo intercalare di pregio

CHIUSURA
una cornice per la boiserie

BATTISCOPA
la base solida di forte percezione visiva

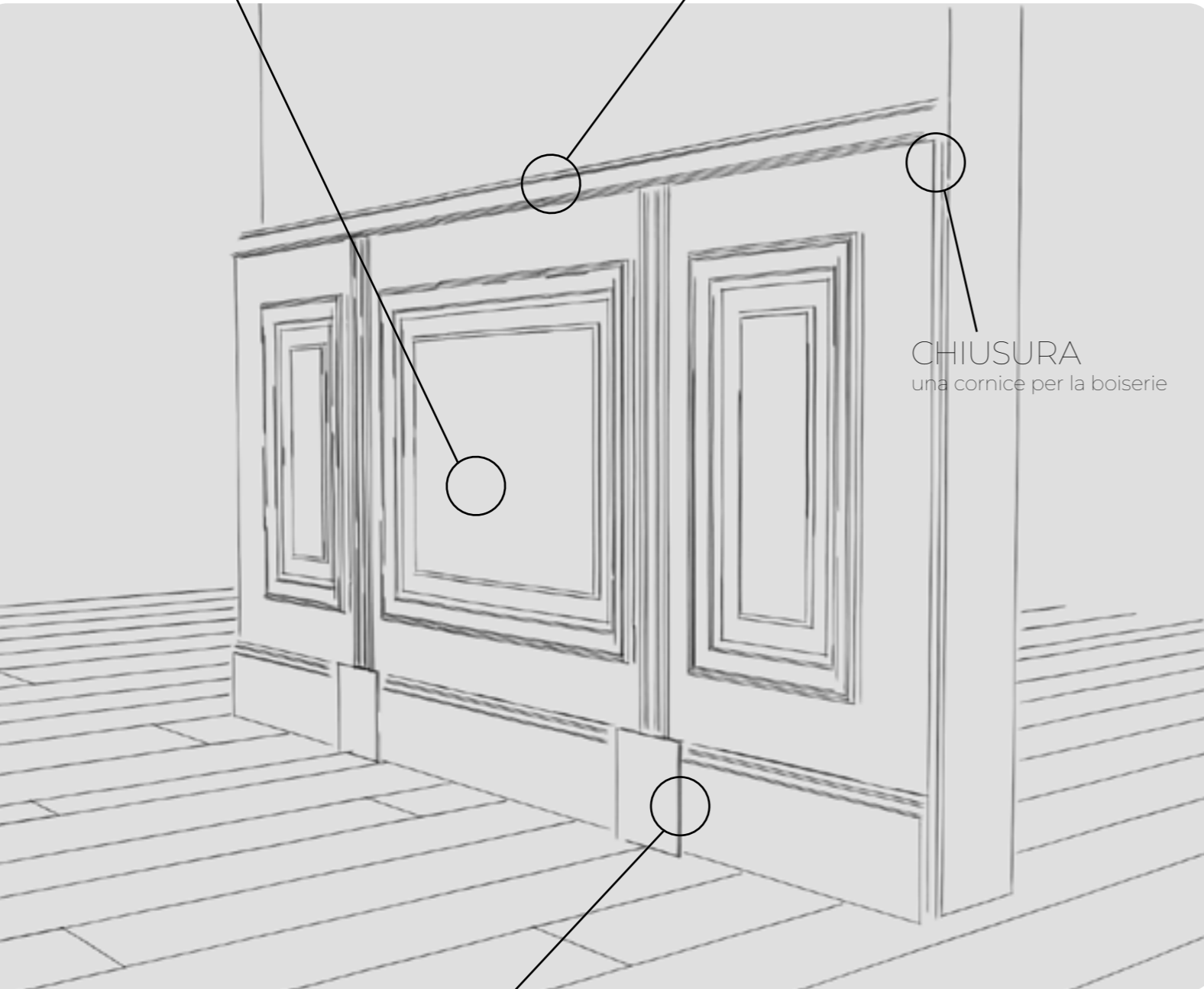

Sistema Boiserie

Boiserie System



Maniglie / Handles
con rosetta patent

NAXOS



BOSTON



IDRA



ASTI



SOLIS



MILLY



EOS



TIME



TORINO L



KIS



Maniglie
Handles

Finiture



Pandora Hide Pandora Pandora **Pandora** Pandora



Pandora Pandora Pandora Pandora Pandora

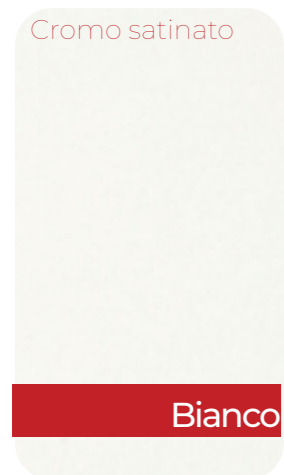

Pandora Lexi



Diciannove Diciannove

Finiture



Hide Filo Hide Filo Hide Hide Hide Filo



Velo Filo Velo Filo Velo Velo



Lac Wood Filo Panto Lac Wood Filo Panto Wood Filo Panto Wood Filo Panto Wood

*telaio opaco liscio

MANI D'APERTURA
Openings Hands



Battente
Swing



Scorrevole interno muro
Inner-wall sliding



Filo
Reversed swing



Rasomuro
Flush with the wall

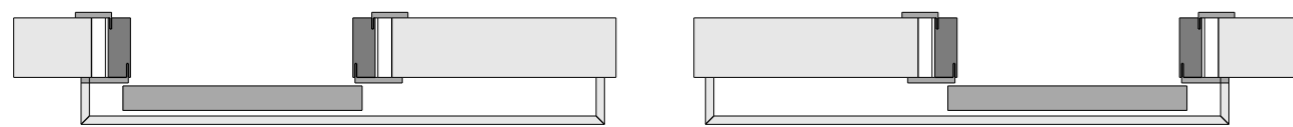

Scorrevole esterno muro
External sliding



Libro
(per porte con anuba)



Dx Tirare

Sx Tirare

Metà
(libro a tirare per porte con cerniere a scomparsa)



Pieghevole
Asymmetrical folding

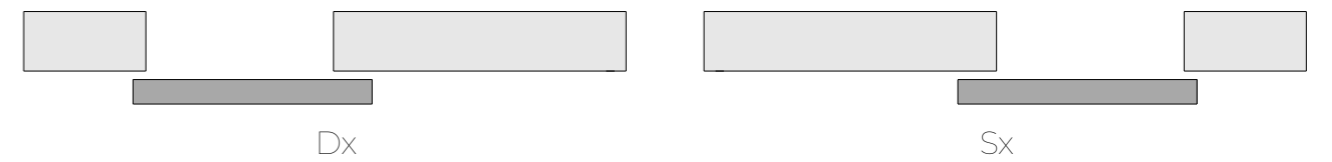

Magic con piastra
Magic with plate

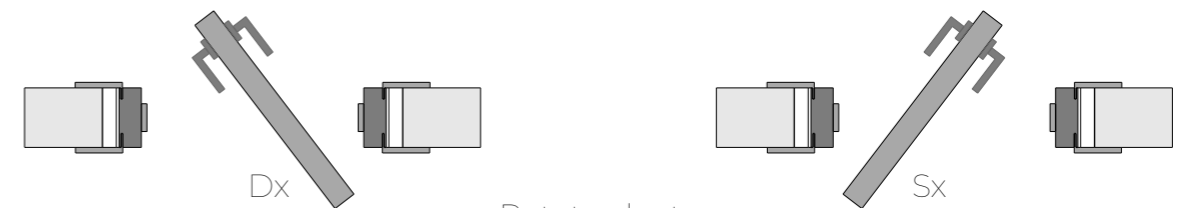

Rototraslante
Pivot sliding



Compact
Compact

