



**LISTINO GENERALE**  
**GENERAL PRICE LIST**



**Nota introduttiva:** passandoci un ordine, l'acquirente accetta le seguenti condizioni. Il presente listino annulla e sostituisce il precedente e potrà essere da noi variato in qualsiasi momento senza alcun obbligo di preavviso. I prezzi riportati sono in **Euro - IVA ESCLUSA**.

- **Ordini:** tutti gli ordini sono sviluppati da RES e inviati all'acquirente affinché ne verifichi l'esattezza e ne dia conferma definitiva. Per la messa in lavorazione occorre apporre timbro con firma su tutti i fogli (disegni compresi) e restituirli il prima possibile con pagamento dell'acconto qualora precedentemente concordato. Si raccomanda un attento controllo della conferma da parte del cliente e l'immediata segnalazione di eventuali errori.
- **Modifica dei preventivi:** l'eventuale modifica non comporta il riscontro istantaneo, ma uno slittamento nel tempo dovuto alla rielaborazione della quotazione.
- **Modifica dell'ordine:** gli ordini si intendono acquisiti da RES solo alla ricezione di tutta la documentazione controfirmata per accettazione. In caso di modifica l'acquirente deve darne comunicazione entro 2 giorni (che saranno evase entro 5 giorni lavorativi).
- **Tempistiche:** la produzione riprenderà una volta ricevuto pagamento, qualora concordato, e documento controfirmato con ultime modifiche richieste.
- **Termini di consegna:** i termini di consegna citati nella nostra conferma d'ordine sono puramente indicativi e non potranno costituire elemento per l'annullamento dell'ordine e/o risarcimento di danni.
- **Annullamento dell'ordine:** RES si riserva la facoltà di valutare l'avanzamento dell'ordine e di verificare stima dei costi già sostenuti che verranno addebitati. Per gli articoli già prodotti verrà addebitato il 100% del valore di tali articoli.
- **Condizioni:** nella conferma d'ordine sono indicate le condizioni.
- **Spedizione:** la merce per l'Italia viene spedita in porto franco per ordini netti superiori a € 2400. Al di sotto di questo importo netto saranno addebitate le spese di spedizione dipendenti da peso/volume. La merce viaggia a cura del committente il quale, al momento della ricezione, ha l'obbligo di eseguire il controllo su quantità e stato dell'imballaggio e segnalare per iscritto al corriere le anomalie riscontrate, essendo escluso qualsiasi indennizzo per danni e spese collegati al reclamo. La spedizione avviene con la merce imballata in cartoni di qualità superiore. Eventuali contestazioni della merce devono essere segnalate per iscritto entro 8 giorni dal suo ricevimento unitamente al documento di trasporto.
- **Resi:** non si accettano resi se non autorizzati per iscritto da RES.
- **Finiture:** i colori e i materiali delle varie partite possono variare, pertanto il campionario legni, cristalli ed anodizzati è puramente indicativo e non può essere materia di contestazioni; in quanto puramente indicativi.

Il Foro competente è il tribunale di Monza.

**Note:** by placing an order with us, the buyer accepts the following conditions. This price list cancels and replaces the previous one and may be changed by us at any time without any obligation of notice. The prices shown are in **Euros - EXCLUDING VAT**.

- **Orders:** all orders are developed by RES and sent to the buyer to verify their accuracy and give definitive confirmation. For processing, a stamp and signature must be affixed to all sheets (including drawings) and return them as soon as possible with payment of the deposit if previously agreed. Careful checking of the confirmation by the customer and immediate confirmation is recommended reporting any errors.
- **Modification of estimate:** any modification does not entail instant feedback, but a postponement in the time due to the re-processing of the quotation.
- **Modification of the order:** orders are considered acquired by RES only upon receipt of all documentation countersigned for acceptance. In case of modification the buyer must give notice communication within 2 days (which will be processed within 5 working days).
- **Timing:** production will resume once payment, if agreed, and document have been received countersigned with latest requested changes.
- **Delivery Terms:** The delivery terms mentioned in our order confirmation are purely indicative and cannot constitute an element for the cancellation of the order and/or compensation for damages.
- **Cancellation of the order:** RES reserves the right to evaluate the progress of the order and verify estimate of costs already incurred that will be charged. For items already produced, 100% will be charged of the value of such items.
- **Conditions of sale:** the conditions are indicated in the order confirmation.
- **Shipping terms:** Goods are ex-factory. Custom duties and all other taxes are paid by the customer. Goods travel at the care of the customer who, upon receipt, has the obligation to carry out checks on quantity and state of the packaging and report any anomalies found, being excluded any compensation for damages and expenses related to the complaint. The shipment takes place with the goods packaged insuperior quality cartons. Any complaints regarding the goods must be reported in writing by 8 days from receipt together with the transport document.
- **Returns:** returns are not accepted unless authorized in writing by RES.
- **Finishes:** the colors and materials of the various batches may vary, therefore the wood, crystal and anodized is purely indicative and cannot be a matter of dispute; as purely indicative.

The competent court is the court of Monza.



**DOGA 05**

LISTINO PREZZI / PRICE LIST 08

**SINGLY 25**

LISTINO PREZZI / PRICE LIST 28

**WAVE 37**

LISTINO PREZZI / PRICE LIST 39

**CARVEL 47**

LISTINO PREZZI / PRICE LIST 50

**MOBILI SOSPESI / HANGING UNITS 53**

LISTINO PREZZI / PRICE LIST 55

**LEVIA 59**

LISTINO PREZZI / PRICE LIST 62

**LUNA 65**

LISTINO PREZZI / PRICE LIST 68

**MISS 73**

LISTINO PREZZI / PRICE LIST 76

**D35 79**

LISTINO PREZZI / PRICE LIST 82

**FAN 87**

LISTINO PREZZI / PRICE LIST 90

**10.8 93**

LISTINO PREZZI / PRICE LIST 95

**CLICK 97**

LISTINO PREZZI / PRICE LIST 100

**STIPITI, MECCANISMI E BINARI / DOOR JAMBS, MECHANISMS AND RAILS 103**

**MANIGLIE / HANDLES 119**

**SIDUS 121**

LISTINO PREZZI / PRICE LIST 125





DOGA

## INFO TECNICHE DOGA DATA SHEET

Doga è un sistema boiserie realizzato in HDF e doghe in HDF, completo di porte integrate con telaio e stipse in alluminio (vedi NOTE), sia a tirare che a spingere, e di tutti gli accessori necessari alla progettazione delle pareti, quali vani ispezionabili, prese elettriche, predisposizioni per tv, mensole. La peculiarità sono le doghe, nelle finiture Legno, Legno Speciale, Laccati Opachi, Laccati Speciali, e fissate ad un pannello di fondo, a sua volta fissato alla parete. Il senso della vena è verticale, sia sui pannelli che sulle doghe. Il prodotto viene realizzato su misura, partendo da un disegno fornito dal cliente e successivamente sviluppato da RES. Il sistema può essere integrato con stripes led a luce calda, posizionati nella parte superiore o inferiore della boiserie, o inserite verticalmente nelle doghe.

Doga is a wall paneling system made by veneered HDF and slats, with integrated doors with aluminium frame and door jamb (see NOTES), complete with all the accessories needed to design the wall, like open space for inspection, sockets, TV compartment, shelves. Peculiarity of the system are the slats, in the finishing Wood, Special Wood, Lacquered, Special Lacquered, and fixed to a back panel attached to the wall. Veneer is vertical, both on panels and slat. Doga is realized on size, starting from a drawing made by the customer and subsequently developed by RES. The system can be integrated with warm light LED stripes, positioned in the upper or lower part of the boiserie, or inserted vertically into the slats.

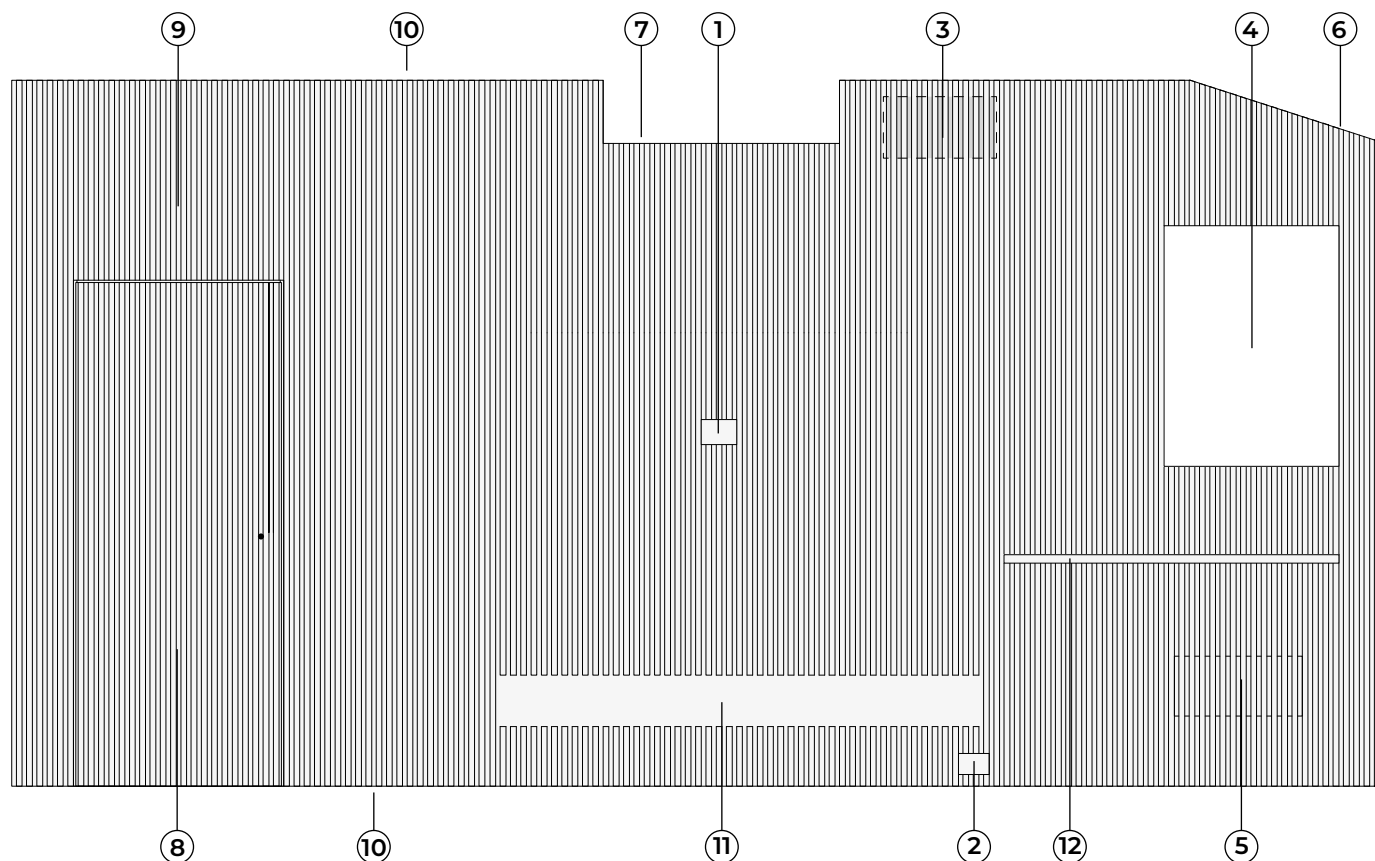

### ELEMENTI / ELEMENTS

- |   |
|---|
| 1. Predisposizione per tv / Set up for tv - pag. 11                                       |
| 2. Predisposizione per prese o interruttori / Set up for sockets or switches - pag. 11    |
| 3. Predisposizione per vano di aerazione / Set up for ventilation - pag. 12               |
| 4. Predisposizione per finestra / Set up for window - pag. 11                             |
| 5. Pannello ispezionabile removibile / Removable inspectionable panel - pag. 12           |
| 6. Predisposizione per soffitto inclinato / Set up for inclined ceiling - pag. 12         |
| 7. Predisposizione per taglio trave o gradino / Set up for beam or step cutting - pag. 12 |
| 8. Porta / Door - pag. 13   |
| 9. Sopraluce / Overdoor - pag. 15   |
| 10. Barra a led / Stripe led - pag. 24  |
| 11. Predisposizione per unità sospesa / Set up for hanging cabinet - pag. 11              |
| 12. Mensola / Shelf - pag. 58   |

**NOTE:** per i mobili sospesi vedi da pagina 53.

**NOTES:** for hanging units see from page 53.



**LEGNI / WOOD**



Canaletto



Rovere

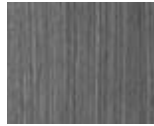

Rovere Grigio



Rovere TT

**LEGNI SPECIALI / SPECIAL WOOD**



Sand



Lava

**LACCATI OPACHI / MATT LACQUERED**

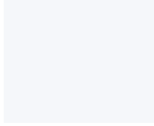

Neve



Corda



Fango



Tabacco



Caffè



Grigio



Antracite



Nero

**LACCATI SPECIALI / SPECIAL LACQUERED**



Bronzo



Piombo



Argento



Oro



Grafite



Platino

**METALLI / METALS**



Anodizzato Titanio



Anodizzato Bronzo Scuro

**NOTE**

La finitura Anodizzato Titanio dei telai e degli stipiti delle porte è abbinata coi legni Canaletto, Rovere, Rovere Grigio e Sand.  
La finitura Anodizzato Bronzo Scuro dei telai e degli stipiti delle porte è abbinata coi legni Rovere TT e Lava.

**NOTES**

The Anodizzato Titanio finish of the frames and door jambs is combined with the Canaletto, Rovere, Rovere Grigio and Sand woods.  
The Anodizzato Bronzo Scuro finish of the door frames and jambs is combined the Rovere TT and Lava woods.

# PANNELLI DOGA PANELS

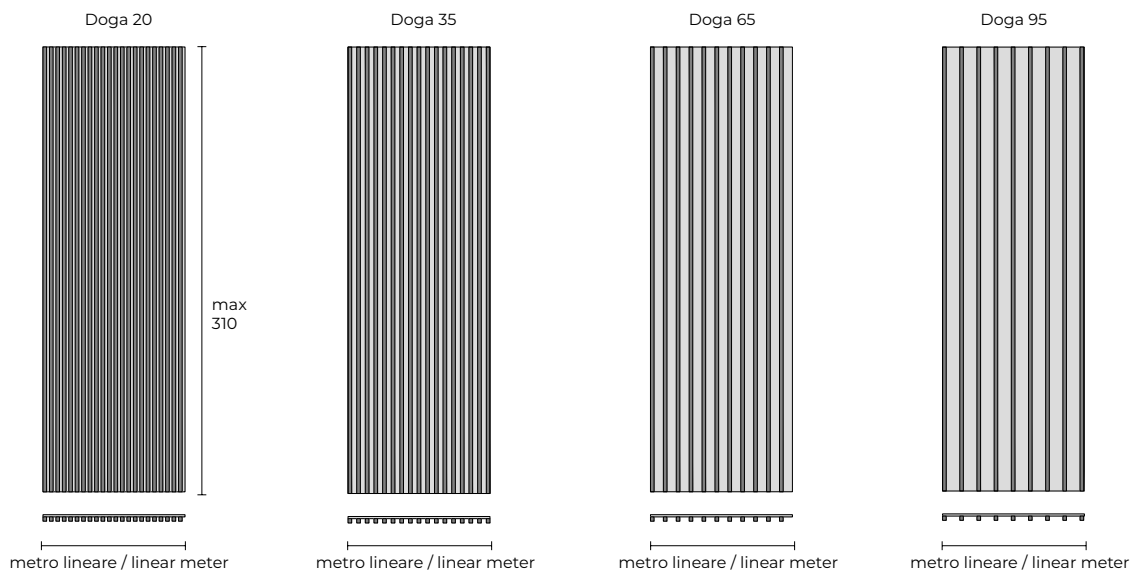

## PANNELLI FINITURA LACCATO OPACO O LEGNO / MATT LACQUERED OR WOOD FINISH PANELS cod. BODPA

Altezza / Height	Doga 20 €/ml	Doga 35 €/ml	Doga 65 €/ml	Doga 95 €/ml
0 > 50	<b>389</b>	<b>332</b>	<b>299</b>	<b>279</b>
50,1 > 100	<b>778</b>	<b>664</b>	<b>598</b>	<b>558</b>
100,1 > 150	<b>1167</b>	<b>996</b>	<b>897</b>	<b>837</b>
150,1 > 200	<b>1556</b>	<b>1328</b>	<b>1196</b>	<b>1116</b>
200,1 > 250	<b>1788</b>	<b>1657</b>	<b>1494</b>	<b>1394</b>
250,1 > 280	<b>1977</b>	<b>1828</b>	<b>1644</b>	<b>1532</b>
280,1 > 310	<b>2440</b>	<b>2225</b>	<b>1970</b>	<b>1822</b>

## PANNELLI FINITURA LACCATO SPECIALE O LEGNO SPECIALE / SPECIAL LACQUERED OR SPECIAL WOOD FINISH PANELS cod. BODPA

Altezza / Height	Doga 20 €/ml	Doga 35 €/ml	Doga 65 €/ml	Doga 95 €/ml
0 > 50	<b>504</b>	<b>425</b>	<b>377</b>	<b>349</b>
50,1 > 100	<b>1008</b>	<b>850</b>	<b>754</b>	<b>698</b>
100,1 > 150	<b>1512</b>	<b>1275</b>	<b>1131</b>	<b>1047</b>
150,1 > 200	<b>2016</b>	<b>1700</b>	<b>1508</b>	<b>1396</b>
200,1 > 250	<b>2323</b>	<b>2122</b>	<b>1884</b>	<b>1744</b>
250,1 > 280	<b>2408</b>	<b>2168</b>	<b>1890</b>	<b>1734</b>
280,1 > 310	<b>2679</b>	<b>2414</b>	<b>2107</b>	<b>1933</b>

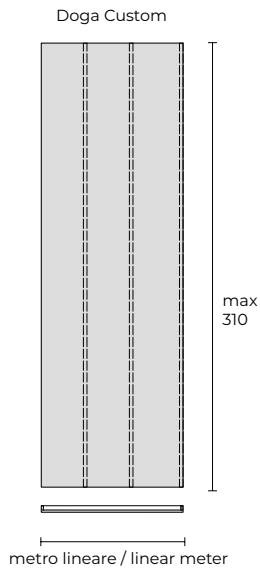

**PANNELLO CUSTOM / CUSTOM PANEL**

cod. BODPA

Altezza / Height	Laccati Opachi o Legni / Matt Lacquered or Wood	Laccati Speciali o Legni Speciali / Special Lacquered or Special Wood
	€/ml	€/ml
0 > 50	156	190
50,1 > 100	312	380
100,1 > 150	468	570
150,1 > 200	624	760
200,1 > 250	780	950
250,1 > 280	852	1040
280,1 > 310	964	1176

**DOGA SINGOLA / SINGLE SLATS**

cod. DOGASI

Altezza / Height	Laccati Opachi o Legni / Matt Lacquered or Wood	Laccati Speciali o Legni Speciali / Special Lacquered or Special Wood
	€/ml	€/ml
0 > 50	14	16
50,1 > 100	28	32
100,1 > 150	42	48
150,1 > 200	60	64
200,1 > 250	70	81
250,1 > 280	78	90
280,1 > 310	87	100

# ELEMENTI EXTRA DOGA

## EXTRA ELEMENTS

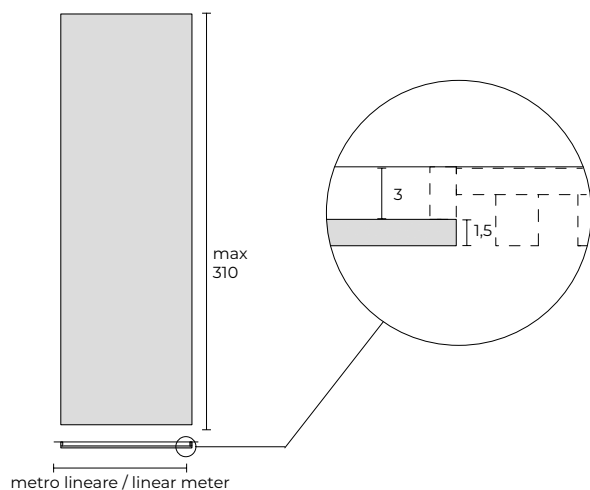

### PANNELLI SPESSORATI

cod. BODPA

Altezza / Height	Laccati o Legni / Laquered or Woods	Laccati Speciali o Legni Speciali / Special Lacquered or Special Woods
	€/ml	€/ml
0 > 50	<b>184</b>	<b>295</b>
50,1 > 100	<b>368</b>	<b>479</b>
100,1 > 150	<b>552</b>	<b>718</b>
150,1 > 200	<b>736</b>	<b>957</b>
200,1 > 250	<b>920</b>	<b>1196</b>
250,1 > 280	<b>1008</b>	<b>1310</b>
280,1 > 310	<b>1138</b>	<b>1479</b>

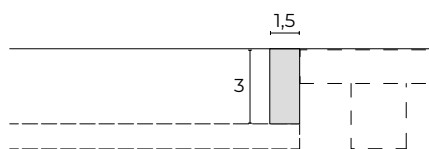

### ELEMENTO DI CHIUSURA LATERALE / SIDE CLOSING ELEMENTS

cod. ELECHI

Finiture / Finishes	€/ml
Laccati Opachi o Legni / Matt Lacquered or Wood	<b>81</b>
Laccati Speciali o Legni Speciali / Special Lacquered or Special Wood	<b>87</b>

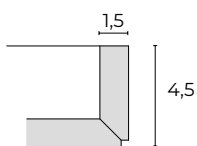

### SUPPLEMENTI / SUPPLEMENTS

cod. TERM45

Terminale tagliato a 45° / Terminal cut at 45°

**80 €**

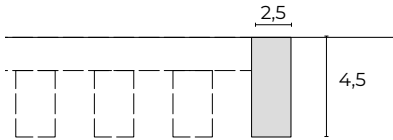

**DOGA TERMINALE / TERMINAL SLATS**

cod. TERMLA

Altezza / Height	Laccati Opachi o Legni / Matt Lacquered or Wood	Laccati Speciali o Legni Speciali / Special Lacquered or Special Wood
0 > 50	18	21
50,1 > 100	36	42
100,1 > 150	54	63
150,1 > 200	72	84
200,1 > 250	90	104
250,1 > 280	101	116
280,1 > 310	112	129

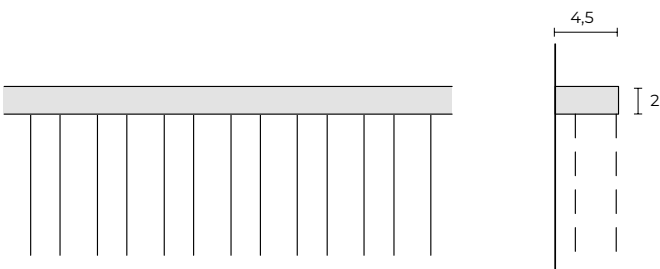

**ELEMENTI DI CHIUSURA INFERIORE O SUPERIORE / LOWER OR HIGHER CLOSING ELEMENTS**

cod. ELECIS

Finiture / Finishes	€/ml
Laccati Opachi o Legni / Matt Lacquered or Wood	70
Laccati Speciali o Legni Speciali / Special Lacquered or Special Wood	81

**PREDISPOSIZIONE PER UNITA' SOSPESA / SET UP FOR HANGING UNITS**

cod. PREUS

Predisposizione / Set up	400 €
--------------------------	-------

**PREDISPOSIZIONE PER STAFFA PORTA TV / SET UP FOR TV STAND BRACKET**

cod. PREDSP

Predisposizione / Set up	220 €
--------------------------	-------

**PREDISPOSIZIONE PER PRESE O INTERRUTTORI / SET UP FOR SOCKETS OR SWITCHES**

cod. PREDPI

Presa o interruttore / Socket or switch	90 € cad/each
---	---------------

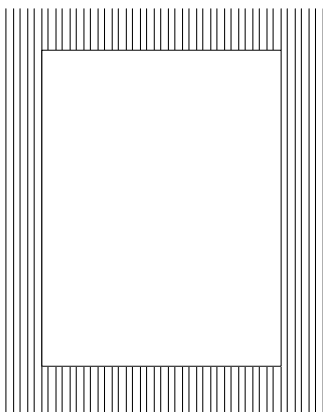

**PREDISPOSIZIONE PER FINESTRA / SET UP FOR WINDOW**

cod. PREFIN

Pannello / Panel	400 € cad/each
------------------	----------------

ELEMENTI EXTRA DOGA  
EXTRA ELEMENTS

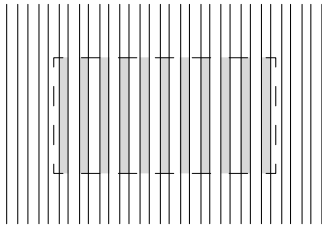

PREDISPOSIZIONE PER VANO DI AERAZIONE / SET UP FOR VENTILATION

cod. PREVAE

Vano di aerazione / Open space

600 € cad/each

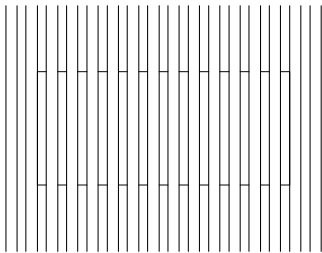

PANNELLO ISPEZIONABILE REMOVIBILE / REMOVABLE INSPECTIONABLE PANEL

cod. PANISP

Pannello / Panel

600 € cad/each

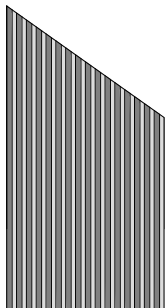

PREDISPOSIZIONE PER SOFFITTO INCLINATO / SET UP FOR INCLINED CEILING

cod. PRESIN

Soffitto inclinato / Inclined ceiling

150 €/ml

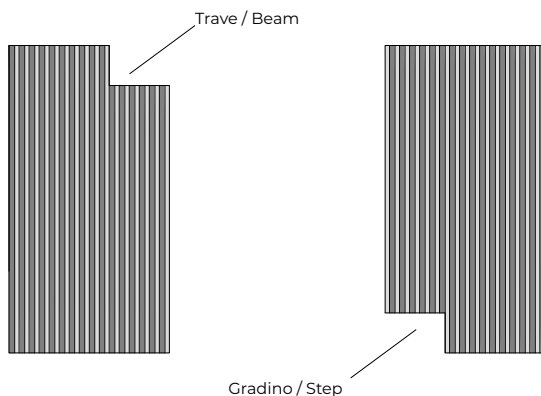

PREDISPOSIZIONE PER TAGLIO TRAVE O GRADINO / SET UP FOR BEAM OR STEP CUTTING

cod. PRETRG

Trave o gradino / Beam or step

90 € cad/each

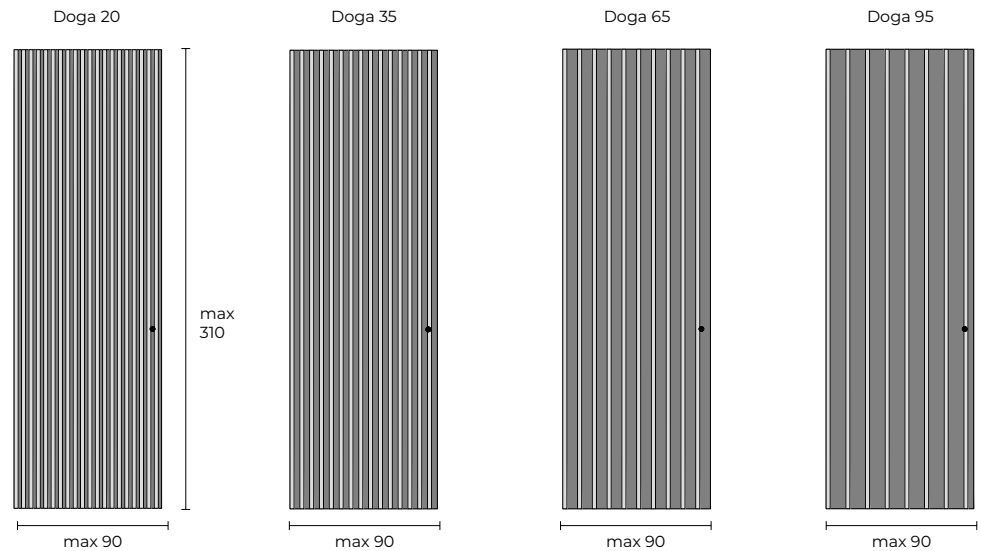

**FINITURA LACCATO OPACO O LEGNO / MATT LACQUERED OR WOOD** cod. BODBT

Larghezza / Length	Altezza / Height	Doga 20	Doga 35	Doga 65	Doga 95
70	0 > 210	<b>2187</b>	<b>2030</b>	<b>1904</b>	<b>1841</b>
80	0 > 210	<b>2284</b>	<b>2126</b>	<b>2032</b>	<b>1937</b>
90	0 > 210	<b>2412</b>	<b>2223</b>	<b>2128</b>	<b>2034</b>
70	210,1 > 240	<b>2376</b>	<b>2196</b>	<b>2052</b>	<b>1980</b>
80	210,1 > 240	<b>2486</b>	<b>2306</b>	<b>2198</b>	<b>2090</b>
90	210,1 > 240	<b>2633</b>	<b>2417</b>	<b>2309</b>	<b>2200</b>
70	240,1 > 310	<b>2680</b>	<b>2455</b>	<b>2275</b>	<b>2184</b>
80	240,1 > 310	<b>2817</b>	<b>2593</b>	<b>2458</b>	<b>2323</b>
90	240,1 > 310	<b>3093</b>	<b>2823</b>	<b>2688</b>	<b>2553</b>

**FINITURA LACCATO SPECIALE O LEGNO SPECIALE / SPECIAL LACQUERED OR SPECIAL WOOD** cod. BODBT

Larghezza / Length	Altezza / Height	Doga 20	Doga 35	Doga 65	Doga 95
70	0 > 210	<b>2843</b>	<b>2639</b>	<b>2475</b>	<b>2394</b>
80	0 > 210	<b>2969</b>	<b>2764</b>	<b>2642</b>	<b>2518</b>
90	0 > 210	<b>3136</b>	<b>2890</b>	<b>2766</b>	<b>2644</b>
70	210,1 > 240	<b>3089</b>	<b>2855</b>	<b>2668</b>	<b>2574</b>
80	210,1 > 240	<b>3232</b>	<b>2998</b>	<b>2858</b>	<b>2717</b>
90	210,1 > 240	<b>3423</b>	<b>3142</b>	<b>3002</b>	<b>2860</b>
70	240,1 > 310	<b>3484</b>	<b>3191</b>	<b>2958</b>	<b>2839</b>
80	240,1 > 310	<b>3662</b>	<b>3371</b>	<b>3195</b>	<b>3020</b>
90	240,1 > 310	<b>4021</b>	<b>3670</b>	<b>3495</b>	<b>3319</b>

# PORTE BATTENTI DOGA SWING DOORS

Doga Custom

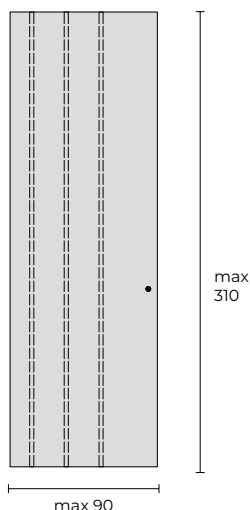

## PORTA BATTENTE DOGA CUSTOM

cod. BODBT

Larghezza/Lenght	Altezza / Height	Laccati Opachi o Legni / Matt Lacquered or Wood	Laccati Speciali o Legni Speciali / Special Lacquered or Special Wood
70	0 > 210	1661	2159
80	0 > 210	1723	2240
90	0 > 210	1785	2320
70	210,1 > 240	1775	2308
80	210,1 > 240	1846	2400
90	210,1 > 240	1916	2491
70	240,1 > 310	1929	2508
80	240,1 > 310	2017	2622
90	240,1 > 310	2553	2851

## DOGA SINGOLA / SINGLE SLATS

cod. DOGASI

Altezza / Height	Laccati Opachi o Legni / Matt Lacquered or Wood	Laccati Speciali o Legni Speciali / Special Lacquered or Special Wood
0 > 50	18	21
50,1 > 100	36	42
100,1 > 150	54	63
150,1 > 200	72	84
200,1 > 250	90	104
250,1 > 280	101	116
280,1 > 310	112	129

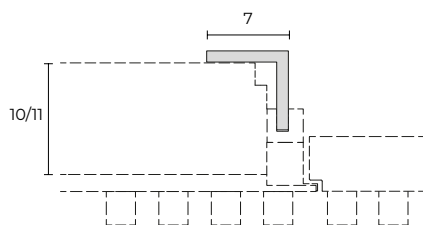

## COPRIFILO LATO INTERNO / INTERNAL SIDE LINING

cod. COPLIN

Larghezza/Lenght	Altezza / Height	Laccati Opachi o Legni / Matt Lacquered or Wood	Laccati Speciali o Legni Speciali / Special Lacquered or Special Wood
70 > 90	0 > 210	158	190
70 > 90	210,1 > 260	195	234
70 > 90	260,1 > 310	233	280



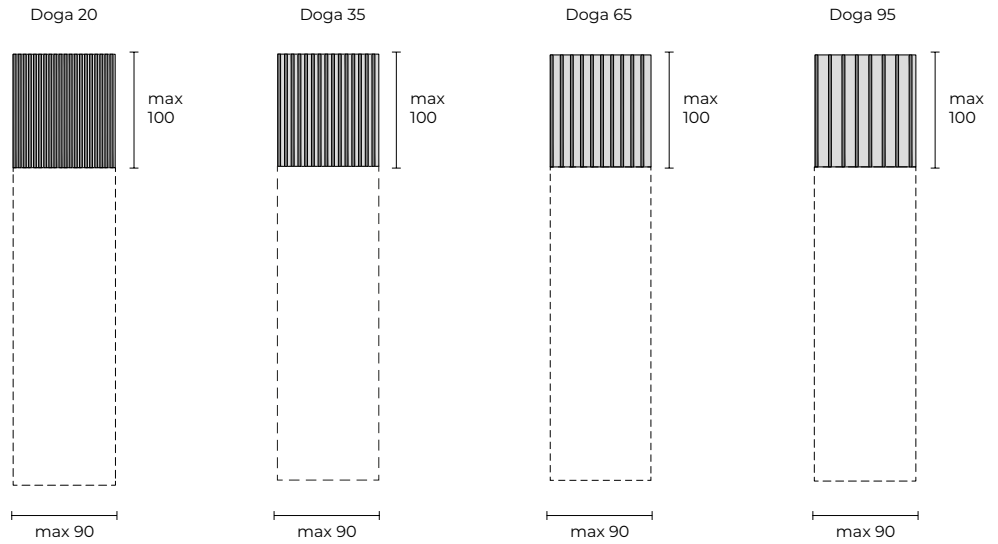

**FINITURA LACCATO OPACO O LEGNO / MATT LACQUERED OR WOOD**

cod. BODSO

Larghezza / Length	Altezza / Height	Doga 20	Doga 35	Doga 65	Doga 95
70	0 > 40	459	369	297	261
80	0 > 40	491	401	347	293
90	0 > 40	541	433	379	325
70	40,1 > 60	508	416	344	308
80	40,1 > 60	544	454	400	346
90	40,1 > 60	600	492	438	384
70	60,1 > 100	599	509	437	401
80	60,1 > 100	649	559	505	451
90	60,1 > 100	717	610	556	502

**FINITURA LACCATO SPECIALE O LEGNO SPECIALE / SPECIAL LACQUERED OR SPECIAL WOOD**

cod. BODSO

Larghezza / Length	Altezza / Height	Doga 20	Doga 35	Doga 65	Doga 95
70	0 > 40	597	480	386	339
80	0 > 40	638	521	451	381
90	0 > 40	703	563	493	422
70	40,1 > 60	660	541	447	400
80	40,1 > 60	767	590	520	450
90	40,1 > 60	780	640	570	498
70	60,1 > 100	779	662	568	521
80	60,1 > 100	844	727	657	586
90	60,1 > 100	932	793	723	653

# SOPRAPORTA DOGA OVERDOOR

Doga Custom

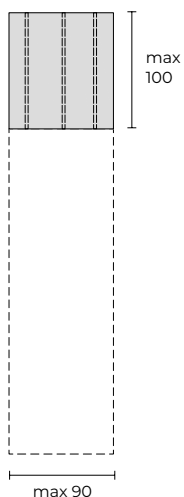

## SOPRAPORTA DOGA CUSTOM / OVERDOOR DOGA CUSTOM

cod. BODSO

Larghezza/Lenght	Altezza / Height	Laccati Opachi o Legni / Matt Lacquered or Wood	Laccati Speciali o Legni Speciali / Special Lacquered or Special Wood
70	0 > 40	231	300
80	0 > 40	245	318
90	0 > 40	259	337
70	40,1 > 60	278	361
80	40,1 > 60	298	387
90	40,1 > 60	318	413
70	60,1 > 100	371	482
80	60,1 > 100	403	524
90	60,1 > 100	436	567

## DOGA SINGOLA / SINGLE SLATS

cod. DOGASI

Altezza / Height	Laccati Opachi o Legni / Matt Lacquered or Wood	Laccati Speciali o Legni Speciali / Special Lacquered or Special Wood
0 > 50	18	21
50,1 > 100	36	42

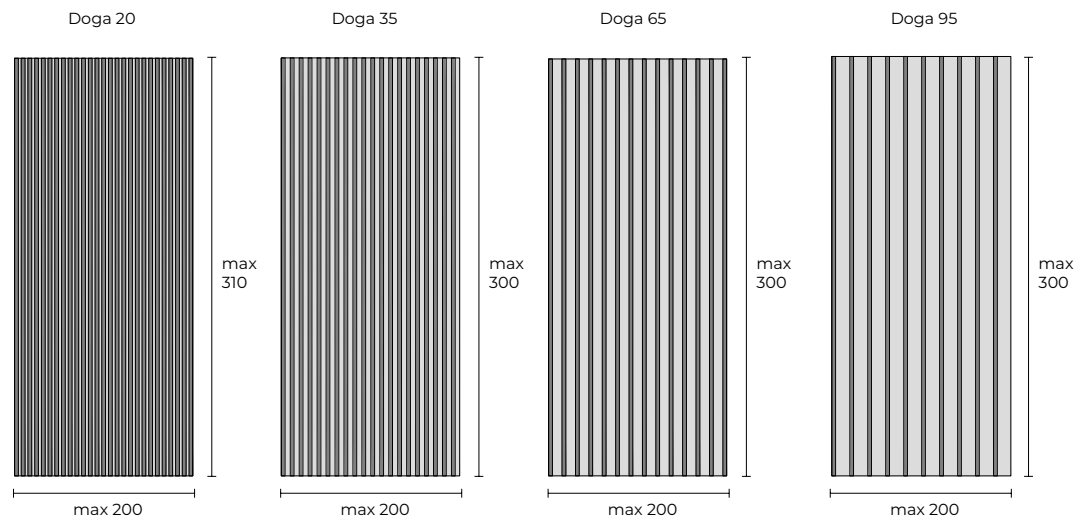

**MONOFACCIALE IN FINITURA LACCATO OPACO O LEGNO / SINGLE SIDED IN MATT LACQUERED OR WOOD** cod. BODBI

Larghezza / Length	Altezza / Height	Doga 20	Doga 35	Doga 65	Doga 95
80 > 100	0 > 240	<b>2185</b>	<b>1937</b>	<b>1677</b>	<b>1573</b>
100,1 > 130	0 > 240	<b>3102</b>	<b>2782</b>	<b>2418</b>	<b>2262</b>
130,1 > 160	0 > 240	<b>3910</b>	<b>3547</b>	<b>3043</b>	<b>2819</b>
160,1 > 200	0 > 240	<b>4784</b>	<b>4328</b>	<b>3768</b>	<b>3432</b>
80 > 100	240,1 > 310	<b>2686</b>	<b>2378</b>	<b>2058</b>	<b>1930</b>
100,1 > 130	240,1 > 310	<b>3807</b>	<b>3403</b>	<b>2955</b>	<b>2763</b>
130,1 > 160	240,1 > 310	<b>4795</b>	<b>4326</b>	<b>3715</b>	<b>3442</b>
160,1 > 200	240,1 > 310	<b>5888</b>	<b>5288</b>	<b>4608</b>	<b>4200</b>

**MONOFACCIALE IN FINITURA LACCATO SPECIALE O LEGNO SPECIALE / SINGLE SIDED IN SPECIAL LACQUERED OR SPECIAL WOOD** cod. BODBI

Larghezza / Length	Altezza / Height	Doga 20	Doga 35	Doga 65	Doga 95
80 > 100	0 > 240	<b>3002</b>	<b>2634</b>	<b>2254</b>	<b>2102</b>
100,1 > 130	0 > 240	<b>4261</b>	<b>3773</b>	<b>3241</b>	<b>3013</b>
130,1 > 160	0 > 240	<b>5346</b>	<b>4770</b>	<b>4041</b>	<b>3730</b>
160,1 > 200	0 > 240	<b>6589</b>	<b>5845</b>	<b>5045</b>	<b>4565</b>
80 > 100	240,1 > 310	<b>3707</b>	<b>3249</b>	<b>2779</b>	<b>2591</b>
100,1 > 130	240,1 > 310	<b>5256</b>	<b>4642</b>	<b>3984</b>	<b>3702</b>
130,1 > 160	240,1 > 310	<b>6594</b>	<b>5855</b>	<b>4973</b>	<b>4581</b>
160,1 > 200	240,1 > 310	<b>8144</b>	<b>7184</b>	<b>6204</b>	<b>5616</b>

# PORTE A BILICO DOGA PIVOT DOORS

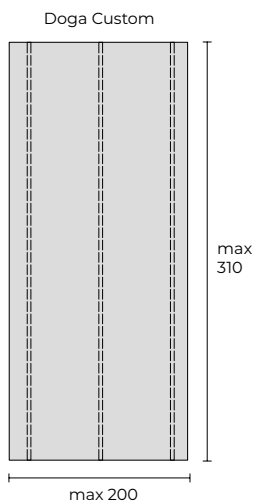

## DOGA CUSTOM

cod. BODBI

Larghezza/Length	Altezza / Height	Laccati Opachi o Legni / Matt Lacquered or Wood	Laccati Speciali o Legni Speciali / Special Lacquered or Special Wood
80 > 100	0 > 240	<b>1070</b>	<b>1407</b>
100,1 > 130	0 > 240	<b>1565</b>	<b>2052</b>
130,1 > 160	0 > 240	<b>1937</b>	<b>2536</b>
160,1 > 200	0 > 240	<b>2344</b>	<b>3093</b>
80 > 100	240,1 > 310	<b>1310</b>	<b>1731</b>
100,1 > 130	240,1 > 310	<b>1903</b>	<b>2512</b>
130,1 > 160	240,1 > 310	<b>2366</b>	<b>3115</b>
160,1 > 200	240,1 > 310	<b>2872</b>	<b>3808</b>

**NOTA:** per il costo della doga singola vedi pagina 14. / **NOTE:** for the cost of the single slats see page 14.

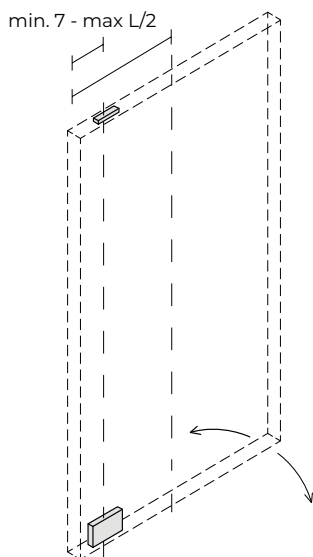

## ELEMENTI / ELEMENTS

cod. SISTPI

### Descrizione / Description

Cerniera per sistema a bilico per porte fino a 500 kg / Hinge for pivot system for doors up to 500 kg

**1400 €\***

\*costi già al netto di sconto / already discounted costs

## SUPPLEMENTI / SUPPLEMENTS

Porta a bilico con doghe su fronte e retro / Pivot door with slats on front and back

**PREZZO SU RICHIESTA / PRICE ON REQUEST**

Battuta per apertura monodirezionale / Stop for one-way opening - COD. STIBDI

**400 €**

Maniglia-doga altezza 6cm / Handle-slats 6cm height

**50 €**

# ANTE BATTENTI PER PORTALI **DOGA**

## HINGED DOORS FOR PORTALS

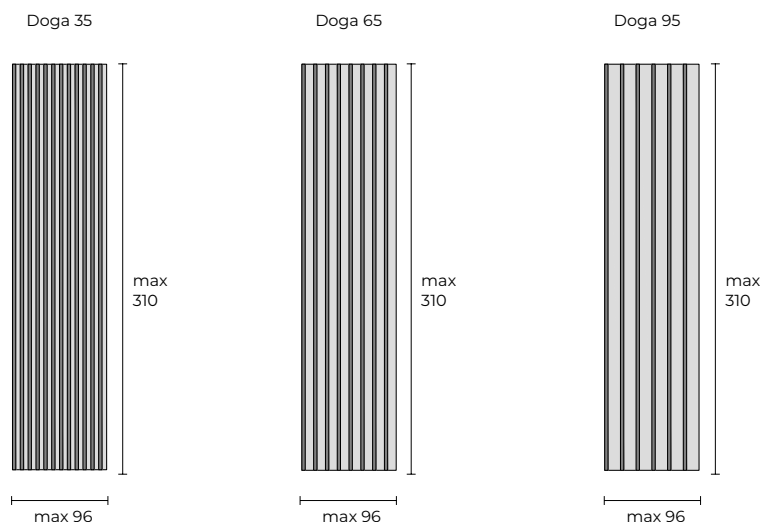

### LACCATO OPACO O LEGNO / MATT LACQUERED OR WOOD cod. BODBP

Larghezza / Width	Altezza / Height	Doga 35	Doga 65	Doga 95
0 > 45	0 > 240	<b>1129</b>	<b>998</b>	<b>921</b>
45,1 > 72	0 > 240	<b>1641</b>	<b>1433</b>	<b>1329</b>
72,1 > 96	0 > 240	<b>1997</b>	<b>1841</b>	<b>1685</b>
0 > 45	240,1 > 310	<b>1357</b>	<b>1197</b>	<b>1101</b>
45,1 > 72	240,1 > 310	<b>1991</b>	<b>1735</b>	<b>1607</b>
72,1 > 96	240,1 > 310	<b>2426</b>	<b>2234</b>	<b>2042</b>

### LACCATO SPECIALE O LEGNO SPECIALE / SPECIAL LACQUERED OR SPECIAL WOOD cod. BODBP

Larghezza / Width	Altezza / Height	Doga 35	Doga 65	Doga 95
0 > 45	0 > 240	<b>1477</b>	<b>1287</b>	<b>1173</b>
45,1 > 72	0 > 240	<b>2191</b>	<b>1887</b>	<b>1735</b>
72,1 > 96	0 > 240	<b>2670</b>	<b>2442</b>	<b>2214</b>
0 > 45	240,1 > 310	<b>1793</b>	<b>1558</b>	<b>1417</b>
45,1 > 72	240,1 > 310	<b>2679</b>	<b>2303</b>	<b>2115</b>
72,1 > 96	240,1 > 310	<b>3267</b>	<b>2985</b>	<b>2703</b>

# ANTE BATTENTI PER PORTALI DOGA HINGED DOORS FOR PORTALS

Doga Custom

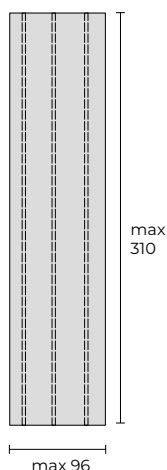

## ANTE BATTENTI PER PORTALI DOGA CUSTOM / DOGA CUSTUM HINGED DOORS FOR PORTALS cod. BODBP

Larghezza/Length	Altezza / Height	Laccati Opachi o Legni / Matt Lacquered or Wood	Laccati Speciali o Legni Speciali / Special Lacquered or Special Wood
0 > 45	0 > 240	<b>695</b>	<b>864</b>
45,1 > 72	0 > 240	<b>950</b>	<b>1212</b>
72,1 > 96	0 > 240	<b>1182</b>	<b>1519</b>
0 > 45	240,1 > 310	<b>824</b>	<b>1034</b>
45,1 > 72	240,1 > 310	<b>1139</b>	<b>1467</b>
72,1 > 96	240,1 > 310	<b>1422</b>	<b>1843</b>

## DOGA SINGOLA / SINGLE SLATS cod. DOGASI

Altezza / Height	Laccati Opachi o Legni / Matt Lacquered or Wood	Laccati Speciali o Legni Speciali / Special Lacquered or Special Wood
0 > 50	<b>18</b>	<b>21</b>
50,1 > 100	<b>36</b>	<b>42</b>
100,1 > 150	<b>54</b>	<b>63</b>
150,1 > 200	<b>72</b>	<b>84</b>
200,1 > 250	<b>90</b>	<b>104</b>
250,1 > 280	<b>101</b>	<b>116</b>
280,1 > 310	<b>112</b>	<b>129</b>

## SUPPLEMENTI / SUPPLEMENTS

Maniglia/doga altezza 6cm / Handle/slats 6cm height

**50 €**

# ANTE A LIBRO PER PORTALI **DOGA** FOLDING DOORS FOR PORTALS

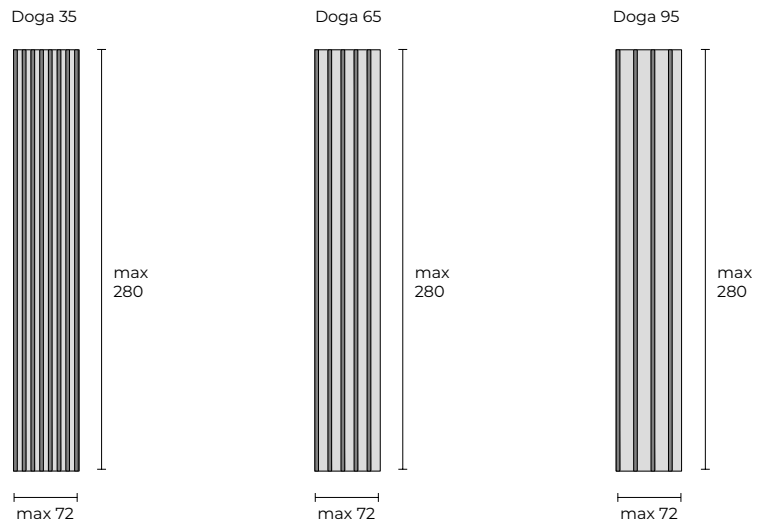

LACCATO OPACO O LEGNO / MATT LACQUERED OR WOOD				cod. BODBL
Larghezza / Width	Altezza / Height	Doga 35	Doga 65	Doga 95
0 > 50	0 > 240	<b>1072</b>	<b>942</b>	<b>864</b>
50,1 > 72	0 > 240	<b>1529</b>	<b>1321</b>	<b>1217</b>
0 > 50	240,1 > 280	<b>1169</b>	<b>1019</b>	<b>929</b>
50,1 > 72	240,1 > 280	<b>1763</b>	<b>1523</b>	<b>1403</b>

LACCATO SPECIALE O LEGNO SPECIALE / SPECIAL LACQUERED OR SPECIAL WOOD				cod. BODBL
Larghezza / Width	Altezza / Height	Doga 35	Doga 65	Doga 95
0 > 50	0 > 240	<b>1439</b>	<b>1249</b>	<b>1135</b>
50,1 > 72	0 > 240	<b>2079</b>	<b>1775</b>	<b>1623</b>
0 > 50	240,1 > 280	<b>1576</b>	<b>1356</b>	<b>1224</b>
50,1 > 72	240,1 > 280	<b>2404</b>	<b>2056</b>	<b>1876</b>

# ANTE A LIBRO PER PORTALI DOGA

## FOLDING DOORS FOR PORTALS

Doga Custom

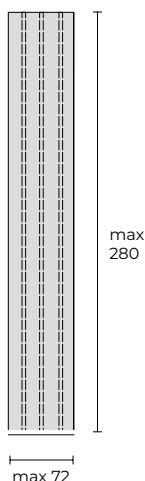

### ANTE A LIBRO PER PORTALI DOGA CUSTOM / DOGA CUSTUM FOLDING DOORS FOR PORTALS cod. BODBL

Larghezza/Lenght	Altezza / Height	Laccati Opachi o Legni / Matt Lacquered or Wood	Laccati Speciali o Legni Speciali / Special Lacquered or Special Wood
0 > 50	0 > 240	<b>634</b>	<b>821</b>
50,1 > 72	0 > 240	<b>838</b>	<b>1100</b>
0 > 50	240,1 > 280	<b>669</b>	<b>865</b>
50,1 > 72	240,1 > 280	<b>965</b>	<b>1270</b>

### DOGA SINGOLA / SINGLE SLATS cod. DOGASI

Altezza / Height	Laccati Opachi o Legni / Matt Lacquered or Wood	Laccati Speciali o Legni Speciali / Special Lacquered or Special Wood
0 > 50	<b>18</b>	<b>21</b>
50,1 > 100	<b>36</b>	<b>42</b>
100,1 > 150	<b>54</b>	<b>63</b>
150,1 > 200	<b>72</b>	<b>84</b>
200,1 > 250	<b>90</b>	<b>104</b>
250,1 > 280	<b>101</b>	<b>116</b>

### SUPPLEMENTI / SUPPLEMENTS

Maniglia/doga altezza 6cm / Handle/slats 6cm height

**50 €**



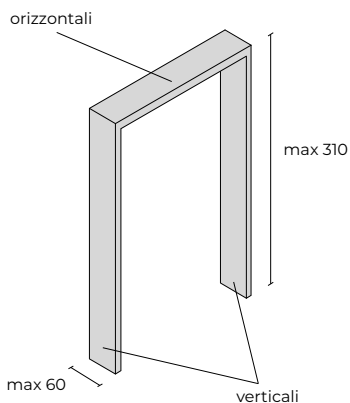

**PORTALI VERTICALI / VERTICAL PORTALS** cod. BODPO

Profondità / Depth	Altezza / Height	Laccato Opaco e Legni / Matt Lacquered and Woods	Laccati Speciali e Legni Speciali / Special Lacquered and Special Woods
12	100 > 250	<b>180</b>	<b>234</b>
25	100 > 250	<b>360</b>	<b>468</b>
45	100 > 250	<b>600</b>	<b>780</b>
60	100 > 250	<b>864</b>	<b>1132</b>
12	250,1 > 310	<b>210</b>	<b>273</b>
25	250,1 > 310	<b>450</b>	<b>585</b>
45	250,1 > 310	<b>810</b>	<b>1053</b>
60	250,1 > 310	<b>1080</b>	<b>1404</b>

**PORTALI ORIZZONTALI / HORIZONTAL PORTALS** cod. BODPO

Profondità / Depth	Laccato Opaco e Legni / Matt Lacquered and Woods	Laccati Speciali e Legni Speciali / Special Lacquered and Special Woods
	€/ml	€/ml
12	<b>72</b>	<b>94</b>
25	<b>144</b>	<b>187</b>
45	<b>240</b>	<b>312</b>
60	<b>345</b>	<b>449</b>

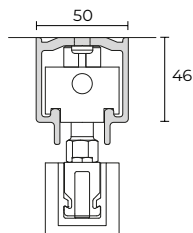

**BINARIO PER ANTE A LIBRO / RAIL FOR FOLDING DOORS** cod. BINALI

Lunghezza / Length	€
100 > 150	<b>120*</b>
150,1 > 210	<b>187*</b>
210,1 > 288	<b>260*</b>

**KIT PER MECCANISMO DI CHIUSURA / CLOSING MECHANISM KIT** cod. KITCAR

Lunghezza / Length	€
100 > 150	<b>488*</b>
150,1 > 210	<b>1300*</b>
210,1 > 288	<b>1460*</b>

\*costi già al netto di sconto  
\*already discounted costs

## BARRE A LED DOGA STRIP LED

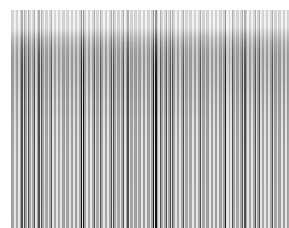
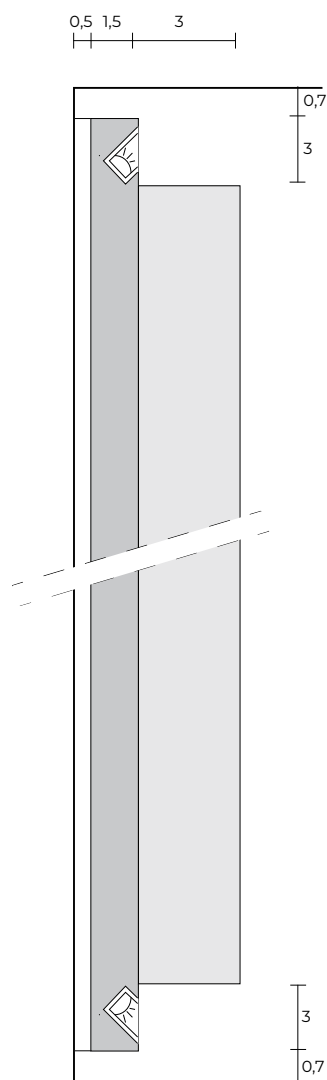

led superiore  
upper led

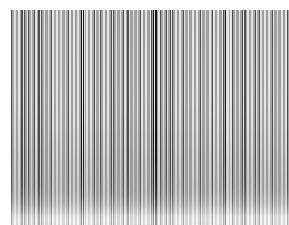

led inferiore  
lower led

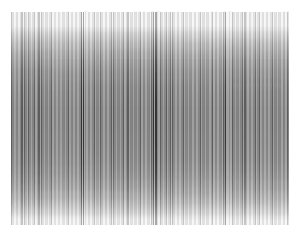

led superiore e inferiore  
upper and lower led

Kit di illuminazione a led composto da stripes led e da un alimentatore  
I led sono alloggiati all'interno di una canalina in alluminio. Temperatura led: 3000° K.  
Led lighting kit consisting of led stripes and a transformer  
The leds are housed inside an aluminum profile. 3000° K.

### BARRE A LED ORIZZONTALI / HORIZONTAL STRIP LED

cod. LEDORI

Led superiore / Upper Led	160 €/ml
Led inferiore / Lower Led	160 €/ml
Led superiore e inferiore / Upper and lower Led	320 €/ml
Trasformatore (max 3 metr) / Transformer (max 3 meters)	<b>compreso / included</b>

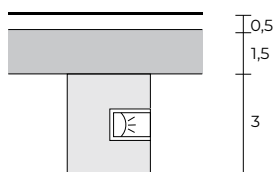

### BARRE A LED VERTICALI / VERTICAL STRIP LED

cod. LEDVER

Stripes led / Led stripes	180 €/ml
Trasformatore (max 3 metr) / Transformer (max 3 meters)	<b>compreso / included</b>



SINGLY

## INFO TECNICHE SINGLY DATA SHEET

Singly è un sistema boiserie altamente personalizzabile, costituito da una struttura a cui sono fissati dei pannelli di rivestimento che possono spaziare dal vetro, ai legni, ai gres porcellanati. Lo stipite, che può essere sia a tirare che a spingere, è fissato al vano muro mediante apposite clips. Infine la porta, di 45mm di spessore, è costituita da un telaio sul quale si possono montare tutta una serie di pannelli. Questa varietà di pannelli rappresenta il cuore di Singly, la cui peculiarità è quella di poter essere completata con una serie di materiali di diversa natura e effetti quali vetri retrolaccati, sia acidati che trasparenti, pannelli rivestiti in legno, gres porcellanati. La porta è completata da cerniere invisibili e regolabili e da serratura magnetica.

Singly is a custom-designed wall paneling system, made of panels (glass, wood, porcelainized stone). In case of wing doors, the jamb is available with push or pull opening, and is fixed to the wall by specific clips. The door panel is of 45 mm thick or can be in aluminum structure with panels. The wide choice of panels is the core of Singly concept, that can be completed with different materials, such as painted glass, glazed or transparent, wood-covered panels and porcelainized stone. The door is completed by invisible and adjustable hinges and magnetic lock. Finally, Singly system includes a wide range of containers, to satisfy all the possible needs, such as drawers, flaps, open compartments. The structure is made of faced panels, covered with the same finish of the wall cladding.

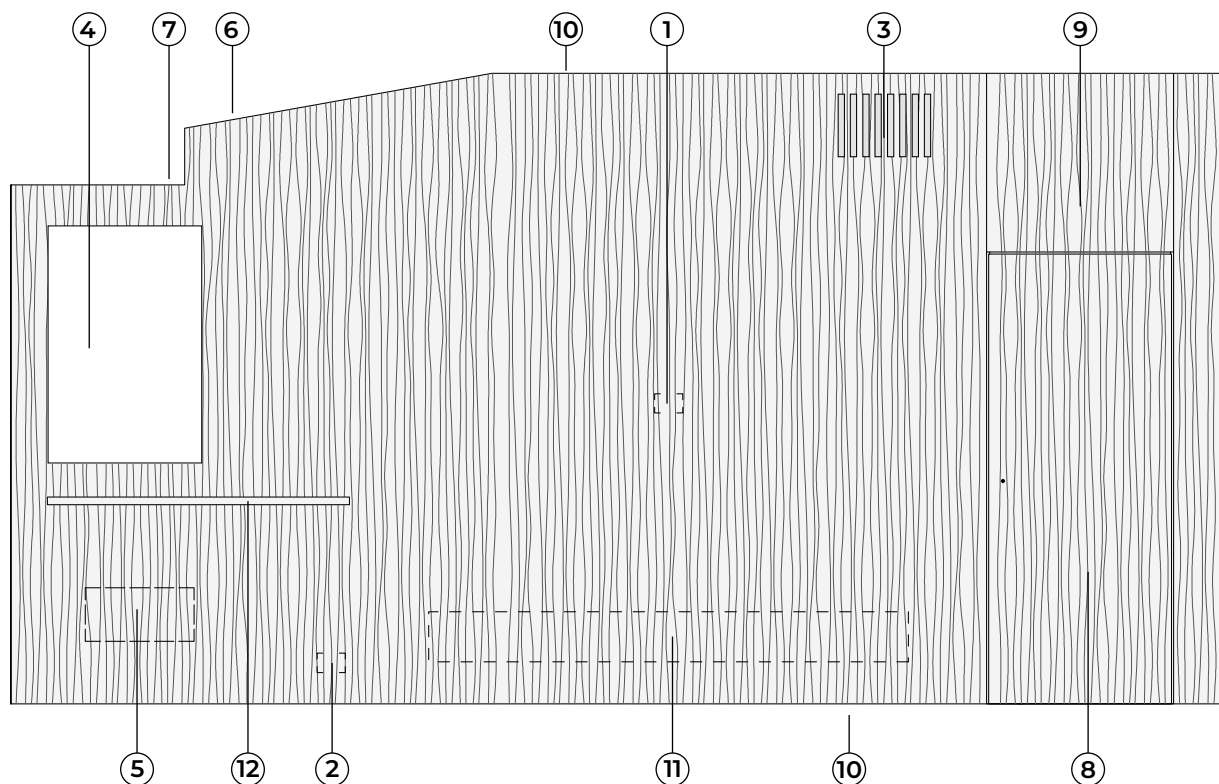

### ELEMENTI / ELEMENTS

- |   |
|---|
| 1. Predisposizione per tv / Set up for tv   |
| 2. Predisposizione per prese o interruttori / Set up for sockets or switches - pag. 29    |
| 3. Predisposizione per vano di aerazione / Set up for ventilation - pag. 30               |
| 4. Predisposizione per finestra / Set up for window - pag. 29                             |
| 5. Pannello ispezionabile removibile / Removable inspectionable panel - pag. 30           |
| 6. Predisposizione per soffitto inclinato / Set up for inclined ceiling - pag. 30         |
| 7. Predisposizione per taglio trave o gradino / Set up for beam or step cutting - pag. 30 |
| 8. Porta / Door - pag. 31   |
| 9. Sopraluce / Overdoor - pag. 31   |
| 10. Barra a led / Stripe led - pag. 35  |
| 11. Predisposizione per unità sospesa / Set up for hanging cabinet                        |
| 12. Mensola / Shelf - pag. 58   |

**NOTE:** per i mobili sospesi vedi a pagina 53.  
**NOTES:** for hanging units see page 53.

**LEGNI / WOOD**



Canaletto



Rovere

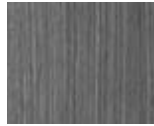

Rovere Grigio



Rovere TT

**LEGNI SPECIALI / SPECIAL WOOD**



Sand



Lava

**LACCATI OPACHI / MATT LACQUERED**

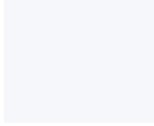

Neve



Corda



Fango



Tabacco



Caffè



Grigio



Antracite



Nero

**LACCATI SPECIALI / SPECIAL LACQUERED**



Bronzo



Piombo

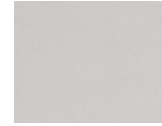

Argento



Oro

**METALLI / METALS**



Anodizzato Titanio



Anodizzato Bronzo Scuro

**NOTE**

La finitura Anodizzato Titanio dei telai e degli stipiti delle porte è abbinata coi legni Canaletto, Rovere, Rovere Grigio e Sand.  
La finitura Anodizzato Bronzo Scuro dei telai e degli stipiti delle porte è abbinata coi legni Rovere TT e Lava.

**NOTES.**

The Anodizzato Titanio finish of the frames and door jambs is combined with the Canaletto, Rovere, Rovere Grigio and Sand woods.  
The Anodizzato Bronzo Scuro finish of the door frames and jambs is combined the Rovere TT and Lava woods.

# PANNELLI SINGLY PANELS

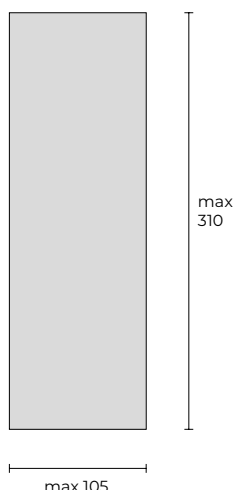

## Finiture pannello / Panel finishes

Cat. A - MDF Grezzo / Raw MDF

Cat. B - Laccati Opachi, Legni\* / Matt Lacquered, Wood\*

Cat. C - Laccati Speciali, Legni Speciali\* / Special Lacquered, Special Wood\*

\* Fornito di serie con venatura verticale / Supplied with vertical veining

NOTA: a richiesta sono disponibili Vetri, Vetri Laccati e Gres Porcellanato.

NOTE: Glass, Lacquered Glass and Porcelain Stoneware are available upon request.

## PANNELLI / PANELS cod. BOSPA

Larghezza / Width	Altezza / Height	Finiture / Finishes		
		A	B	C
0 > 25	0 > 50	90	99	108
25,1 > 50	0 > 50	130	146	162
50,1 > 75	0 > 50	178	202	226
75,1 > 105	0 > 50	227	261	295
0 > 25	50,1 > 100	181	197	215
25,1 > 50	50,1 > 100	259	291	323
50,1 > 75	50,1 > 100	355	403	451
75,1 > 105	50,1 > 100	454	522	590
0 > 25	100,1 > 150	279	303	327
25,1 > 50	100,1 > 150	393	441	488
50,1 > 75	100,1 > 150	534	607	680
75,1 > 105	100,1 > 150	680	782	884
0 > 25	150,1 > 200	378	414	450
25,1 > 50	150,1 > 200	543	614	685
50,1 > 75	150,1 > 200	748	855	962
75,1 > 105	150,1 > 200	1276	1490	1704
0 > 25	200,1 > 250	421	461	501
25,1 > 50	200,1 > 250	607	688	769
50,1 > 75	200,1 > 250	840	961	1082
75,1 > 105	200,1 > 250	1080	1250	1252
0 > 25	250,1 > 280	464	508	552
25,1 > 50	250,1 > 280	672	762	852
50,1 > 75	250,1 > 280	932	1067	1202
75,1 > 105	250,1 > 280	1199	1389	1579
0 > 25	280,1 > 310	492	540	588
25,1 > 50	280,1 > 310	715	812	909
50,1 > 75	280,1 > 310	993	1138	1283
75,1 > 105	280,1 > 310	1279	1482	1685

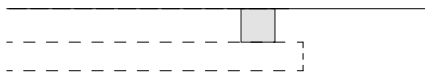

**MONTANTE RETRO STRUTTURA / REAR STRUCTURE UPRIGHT**

cod. MONRES

Montante / Upright

**60 € cad/each**

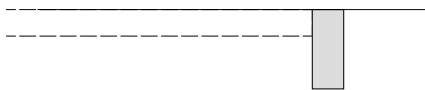

**ELEMENTO DI CHIUSURA LATERALE / SIDE CLOSING ELEMENTS**

cod. ELECHI

Finiture / Finishes	€/ml
Laccati Opachi o Legni / Matt Lacquered or Wood	<b>87</b>
Laccati Speciali o Legni Speciali / Special Lacquered or Special Wood	<b>81</b>

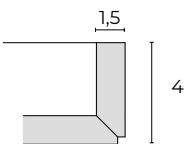

**TERMINALE CON TAGLIO A 45° / TERMINAL CUT AT 45°**

cod. TERM45

Taglio / Cut

**80 € cad/each**

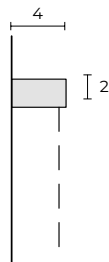
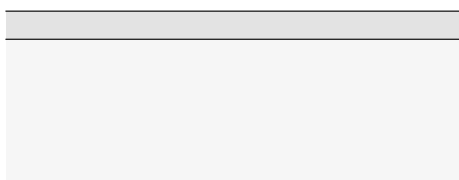

**ELEMENTI DI CHIUSURA INFERIORE O SUPERIORE/ LOWER OR HIGHER CLOSING ELEMENTS**

cod. ELECIS

Finiture / Finishes	€/ml
Laccati Opachi o Legni / Matt Lacquered or Wood	<b>70</b>
Laccati Speciali o Legni Speciali / Special Lacquered or Special Wood	<b>81</b>

**PREDISPOSIZIONE PER PRESE O INTERRUTTORI / SET UP FOR SOCKETS OR SWITCHES**

cod. PREPOI

Presse o interruttore / Socket or switch

**90 € cad/each**

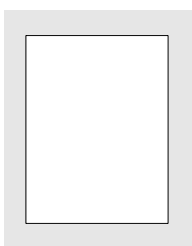

**PREDISPOSIZIONE PER FINESTRA / SET UP FOR WINDOW**

cod. PREFIN

Pannello / Panel

**400 € cad/each**

## ELEMENTI EXTRA SINGLY EXTRA ELEMENTS

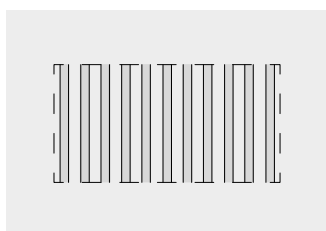

### PREDISPOSIZIONE PER VANO DI AERAZIONE / SET UP FOR VENTILATION

cod. PREVAE

Vano di aerazione / Open space

400 € cad/each

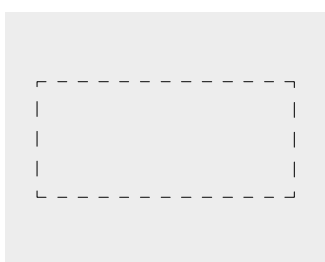

### PANNELLO ISPEZIONABILE REMOVIBILE / REMOVABLE INSPECTIONABLE PANEL

cod. PANISP

Pannello / Panel

280 € cad/each

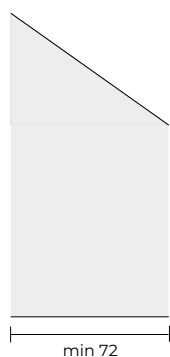

### PREDISPOSIZIONE PER SOFFITTO INCLINATO / SET UP FOR INCLINED CEILING

cod. PRESIN

Soffitto inclinato / Inclined ceiling

90 €/ml

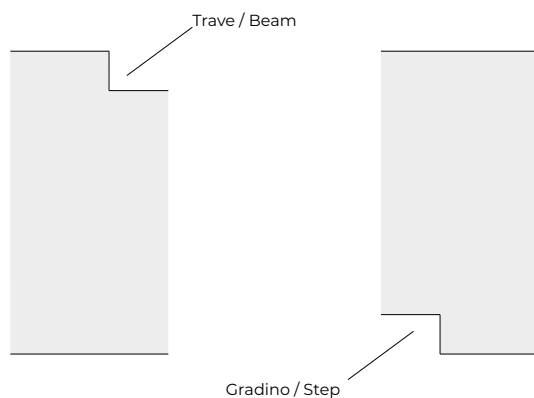

### PREDISPOSIZIONE PER TAGLIO TRAVE O GRADINO / SET UP FOR BEAM OR STEP CUTTING

cod. PRETRG

Trave o gradino / Beam or step

80 € cad/each



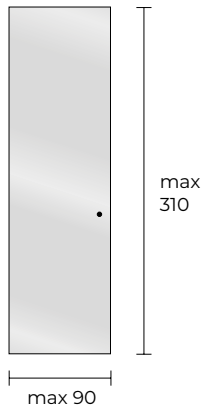

**Finiture pannello / Panel finishes**

Cat. A - MDF Grezzo / Raw MDF

Cat. B - Laccati Opachi, Legni\* / Matt Lacquered, Wood\*

Cat. C - Laccati Speciali, Legni Speciali\* / Special Lacquered, Special Wood\*

\* Fornito di serie con venatura verticale / Supplied with vertical veining

NOTA: a richiesta sono disponibili Vetri, Vetri Laccati e Gres Porcellanato.

NOTE: Glass, Lacquered Glass and Porcelain Stoneware are available upon request.

**PORTE BATTENTI / SWING DOORS** cod. BOSBT

Larghezza / Width	Altezza / Height	Finiture / Finishes		
		A	B	C
70	0 > 210	<b>1705</b>	<b>1855</b>	<b>2005</b>
80	0 > 210	<b>1775</b>	<b>1945</b>	<b>2115</b>
90	0 > 210	<b>1842</b>	<b>2034</b>	<b>2226</b>
70	210,1 > 260	<b>1950</b>	<b>2140</b>	<b>2330</b>
80	210,1 > 260	<b>2038</b>	<b>2251</b>	<b>2464</b>
90	210,1 > 260	<b>2123</b>	<b>2361</b>	<b>2599</b>
70	260,1 > 310	<b>1969</b>	<b>2184</b>	<b>2399</b>
80	260,1 > 310	<b>2067</b>	<b>2311</b>	<b>2555</b>
90	260,1 > 310	<b>2164</b>	<b>2439</b>	<b>2714</b>



**Finiture pannello / Panel finishes**

Cat. A - MDF Grezzo / Raw MDF

Cat. B - Laccati Opachi, Legni\* / Matt Lacquered, Wood\*

Cat. C - Laccati Speciali, Legni Speciali\* / Special Lacquered, Special Wood\*

\* Fornito di serie con venatura verticale / Supplied with vertical veining

NOTA: a richiesta sono disponibili Vetri, Vetri Laccati e Gres Porcellanato.

NOTE: Glass, Lacquered Glass and Porcelain Stoneware are available upon request.

**SOPRA PORTA / OVERDOOR** cod. BOSSO

Larghezza / Width	Altezza / Height	Finiture / Finishes		
		A	B	C
70	0 > 40	<b>239</b>	<b>266</b>	<b>293</b>
80	0 > 40	<b>250</b>	<b>281</b>	<b>312</b>
90	0 > 40	<b>271</b>	<b>306</b>	<b>341</b>
70	40,1 > 60	<b>339</b>	<b>385</b>	<b>431</b>
80	40,1 > 60	<b>358</b>	<b>410</b>	<b>462</b>
90	40,1 > 60	<b>391</b>	<b>449</b>	<b>507</b>
70	60,1 > 100	<b>565</b>	<b>642</b>	<b>719</b>
80	60,1 > 100	<b>597</b>	<b>684</b>	<b>770</b>
90	60,1 > 100	<b>652</b>	<b>748</b>	<b>845</b>

# PORTE A BILICO SINGLY PIVOT DOORS

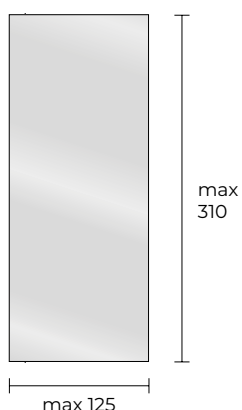

## Finiture pannello / Panel finishes

Cat. A - MDF Grezzo / Raw MDF

Cat. B - Laccati Opachi, Legni\* / Matt Lacquered, Wood\*

Cat. C - Laccati Speciali, Legni Speciali\* / Special Lacquered, Special Wood\*

\* Fornito di serie con venatura verticale / Supplied with vertical veining

NOTA: a richiesta sono disponibili Vetri, Vetri Laccati e Gres Porcellanato.

NOTE: Glass, Lacquered Glass and Porcelain Stoneware are available upon request.

## PORTE A BILICO / PIVOT DOORS

cod. BOSBI

Larghezza / Width	Altezza / Height	Finiture / Finishes		
		A	B	C
80 > 100	0 > 240	<b>1225</b>	<b>1562</b>	<b>1899</b>
100,1 > 125	0 > 240	<b>1758</b>	<b>2245</b>	<b>2732</b>
80 > 100	240,1 > 310	<b>1532</b>	<b>1953</b>	<b>2374</b>
100,1 > 125	240,1 > 310	<b>2198</b>	<b>2807</b>	<b>3415</b>

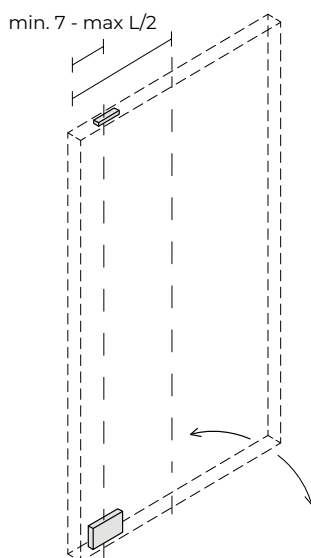

## ELEMENTI / ELEMENTS

cod. SISTPI

### Descrizione / Description

Cerniera per sistema a bilico per porte fino a 500 kg / Hinge for pivot system for doors up to 500 kg

**1400 €\***

\*costi già al netto di sconto / already discounted costs

## SUPPLEMENTI / SUPPLEMENTS

Battuta per apertura monodirezionale / Stop for one-way opening - cod. STIBDI

**400 €**

# ANTE BATTENTI E ANTE A LIBRO PER PORTALI **SINGLY**

## HINGED DOORS AND FOLDING DOORS FOR PORTALS

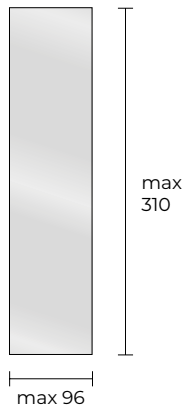

### Finiture pannello / Panel finishes

Cat. A - MDF Grezzo / Raw MDF

Cat. B - Laccati Opachi, Legni\* / Matt Lacquered, Wood\*

Cat. C - Laccati Speciali, Legni Speciali\* / Special Lacquered, Special Wood\*

\* Fornito di serie con venatura verticale / Supplied with vertical veining

NOTA: a richiesta sono disponibili Vetri, Vetri Laccati e Gres Porcellanato.

NOTE: Glass, Lacquered Glass and Porcelain Stoneware are available upon request.

### ANTE BATTENTI / HINGED DOORS

cod. BOSBL

Larghezza / Width	Altezza / Height	Finiture / Finishes		
		A	B	C
0 > 45	0 > 240	<b>750</b>	<b>938</b>	<b>1126</b>
45,1 > 72	0 > 240	<b>973</b>	<b>1235</b>	<b>1497</b>
72,1 > 96	0 > 240	<b>1298</b>	<b>1647</b>	<b>1996</b>
0 > 45	240,1 > 310	<b>843</b>	<b>1190</b>	<b>1537</b>
45,1 > 72	240,1 > 310	<b>1110</b>	<b>1416</b>	<b>1722</b>
72,1 > 96	240,1 > 310	<b>1450</b>	<b>1888</b>	<b>2296</b>

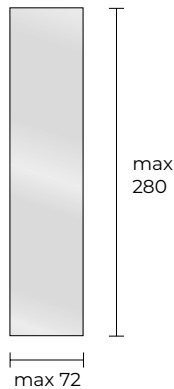

### Finiture pannello / Panel finishes

Cat. A - MDF Grezzo / Raw MDF

Cat. B - Laccati Opachi, Legni\* / Matt Lacquered, Wood\*

Cat. C - Laccati Speciali, Legni Speciali\* / Special Lacquered, Special Wood\*

\* Fornito di serie con venatura verticale / Supplied with vertical veining

NOTA: a richiesta sono disponibili Vetri, Vetri Laccati e Gres Porcellanato.

NOTE: Glass, Lacquered Glass and Porcelain Stoneware are available upon request.

### ANTE A LIBRO / FOLDING DOORS

cod. BOSBL

Larghezza / Width	Altezza / Height	Finiture / Finishes		
		A	B	C
0 > 50	0 > 240	<b>750</b>	<b>938</b>	<b>1126</b>
50,1 > 72	0 > 240	<b>973</b>	<b>1235</b>	<b>1497</b>
0 > 50	240,1 > 280	<b>787</b>	<b>984</b>	<b>1181</b>
50,1 > 72	240,1 > 280	<b>1111</b>	<b>1416</b>	<b>1721</b>

# PORTALI E MECCANISMI SINGLY PORTALS AND MECHANISM

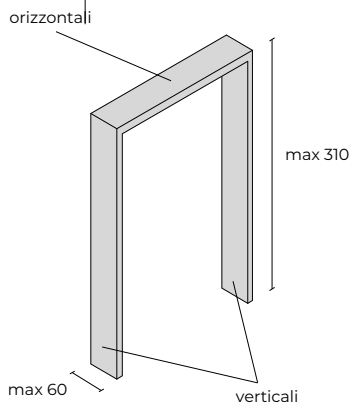

## PORTALI VERTICALI / VERTICAL PORTALS

cod. BOSPO

Profondità / Depth	Altezza / Height	Laccato Opaco e Legni / Matt Lacquered and Woods	Laccati Speciali e Legni Speciali / Special Lacquered and Special Woods
12	100 > 250	<b>180</b>	<b>234</b>
25	100 > 250	<b>360</b>	<b>468</b>
45	100 > 250	<b>600</b>	<b>780</b>
60	100 > 250	<b>864</b>	<b>1132</b>
12	250,1 > 310	<b>210</b>	<b>273</b>
25	250,1 > 310	<b>450</b>	<b>585</b>
45	250,1 > 310	<b>810</b>	<b>1053</b>
60	250,1 > 310	<b>1080</b>	<b>1404</b>

## PORTALI ORIZZONTALI / HORIZONTAL PORTALS

cod. XXXX

Profondità / Depth	Laccato Opaco e Legni / Matt Lacquered and Woods	Laccati Speciali e Legni Speciali / Special Lacquered and Special Woods
	€/ml	€/ml
12	<b>72</b>	<b>94</b>
25	<b>144</b>	<b>187</b>
45	<b>240</b>	<b>312</b>
60	<b>345</b>	<b>449</b>

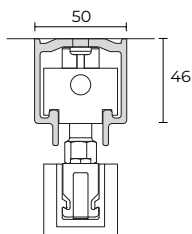

## BINARIO PER ANTE A LIBRO / RAIL FOR FOLDING DOORS

cod. BINALI

Lunghezza / Length	€
100 > 150	<b>120*</b>
150,1 > 210	<b>187*</b>
210,1 > 288	<b>260*</b>

## KIT PER MECCANISMO DI CHIUSURA / CLOSING MECHANISM KIT

cod. KITCAR

Lunghezza / Length	€
100 > 150	<b>488*</b>
150,1 > 210	<b>1300*</b>
210,1 > 288	<b>1460*</b>

\*costi già al netto di sconto  
\*already discounted costs

## BARRE A LED **SINGLY** STRIP LED

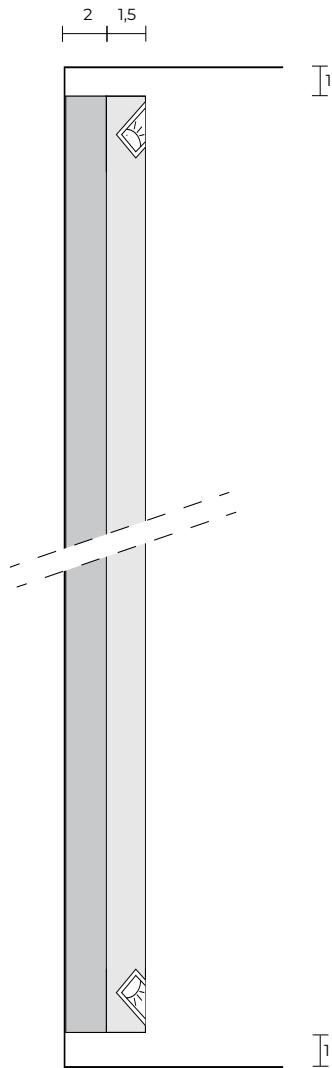

led superiore  
upper led

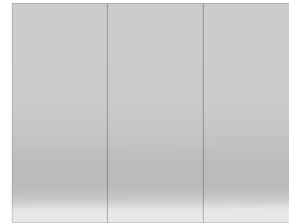

led inferiore  
lower led

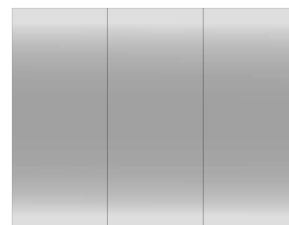

led superiore e inferiore  
upper and lower led

Kit di illuminazione a led composto da stripes led e da un alimentatore  
I led sono alloggiati all'interno di una canalina in alluminio. Temperatura led: 3000° K.  
Led lighting kit consisting of led stripes and a transformer  
The leds are housed inside an aluminum profile. 3000° K.

### BARRE A LED ORIZZONTALI / HORIZONTAL STRIP LED

cod. LEDORI

Led superiore / Upper Led	<b>160 €/ml</b>
Led inferiore / Lower Led	<b>160 €/ml</b>
Led superiore e inferiore/ Upper and lower Led	<b>320 €/ml</b>
Trasformatore (max 3 metr) / Transformer (max 3 meters)	<b>compreso / included</b>





WAVE

# INFO TECNICHE WAVE

## DATA SHEET

Sfruttando uno dei punti di forza di Res, ossia la strutturata falegnameria interna, nasce Wave in versione boiserie, un completamento di un prodotto iconico per Res. La pannellatura in HDF, è scavata verticalmente in maniera irregolare e, fissandosi alla parete mediante un telaio a muro e delle clips, permette di rivestire in maniera semplice e veloce qualsiasi parete. Ciò permette di gestire facilmente le più comuni problematiche quali prese, vani tv, vani ispezionabili. E' ovviamente disponibile con porte integrate, che si contestualizzano perfettamente all'insieme.

Exploiting one of Res's strengths, that is the structured carpentry inside, Wave wall cladding is born, a completion of an iconic product for Res. The HDF paneling is carved vertically in an irregular manner, and fixing to the wall by means of a wall frame and clips, it allows to cover in a simple and fast way any wall, easily managing the most common problems such as sockets, tv rooms, inspectable rooms. Obviously available with integrated doors, which fit perfectly in the wall.

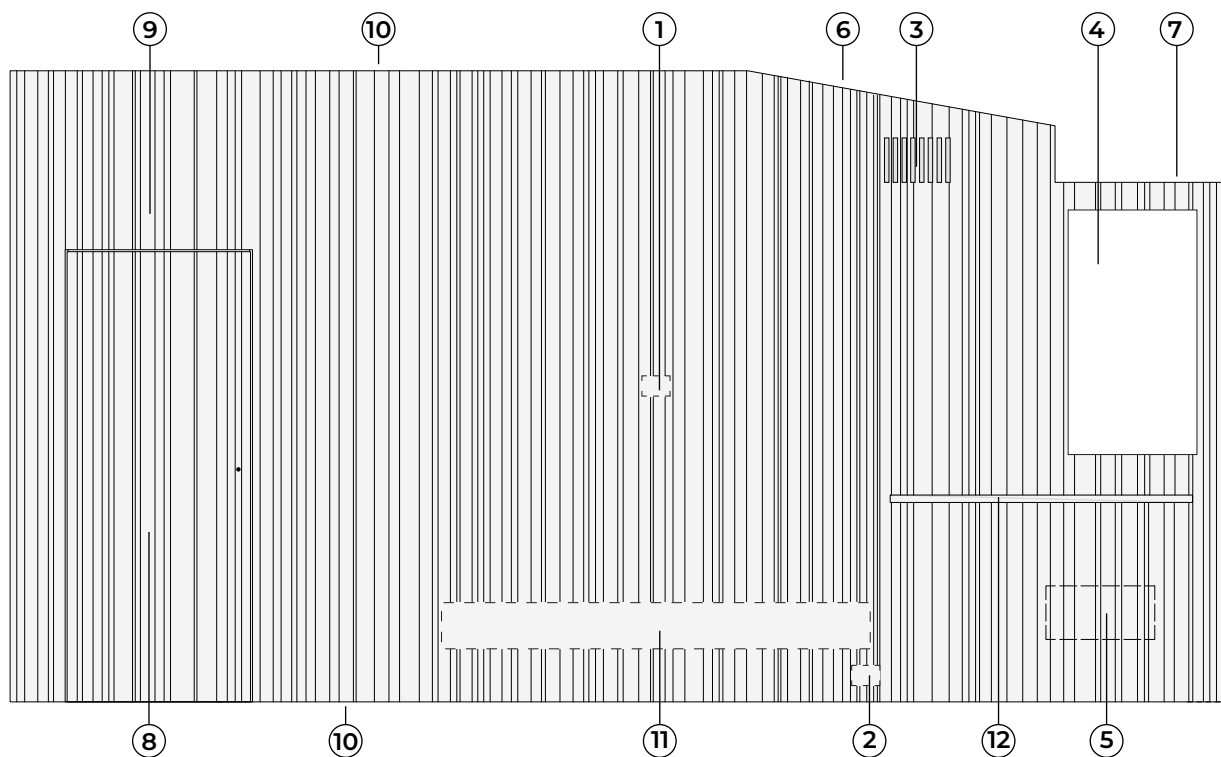

### ELEMENTI / ELEMENTS

- 1. Predisposizione per tv / Set up for tv - pag. 40
- 2. Predisposizione per prese o interruttori / Set up for sockets or switches - pag. 40
- 3. Predisposizione per vano di aerazione / Set up for ventilation - pag. 40
- 4. Predisposizione per finestra / Set up for window - pag. 40
- 5. Pannello ispezionabile removibile / Removable inspectionable panel - pag. 40
- 6. Predisposizione per soffitto inclinato / Set up for inclined ceiling - pag. 40
- 7. Predisposizione per taglio trave o gradino / Set up for beam or step cutting - pag. 40
- 8. Porta / Door - pag. 41
- 9. Sopraluce / Overdoor - pag. 41
- 10. Barra a led / Stripe led - pag. 45
- 11. Predisposizione per unità sospesa / Set up for hanging cabinet
- 12. Mensola / Shelf - pag. 58

**NOTE:** per i mobili sospesi vedi a pagina 53.  
**NOTES:** for hanging units see page 53.

### LACCATI OPACHI / MATT LACQUERED



### LACCATI SPECIALI / SPECIAL LACQUERED

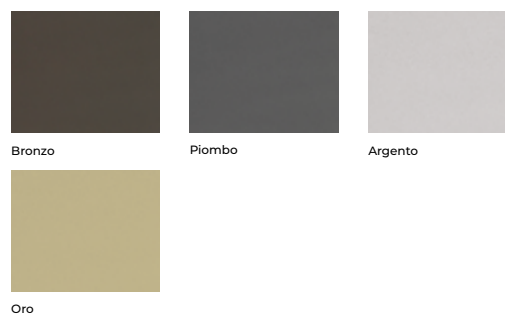



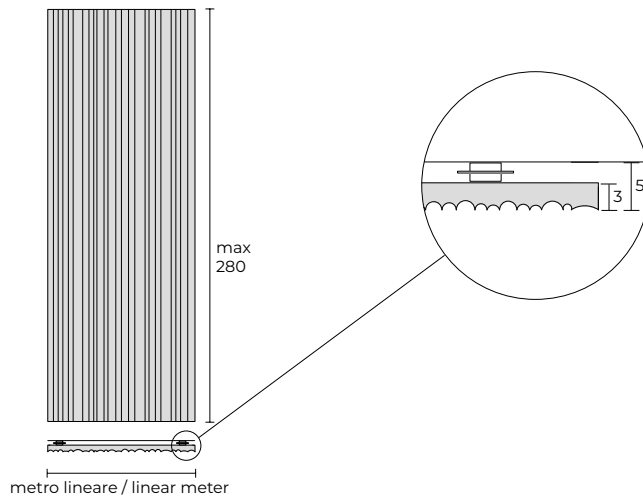

PANNELLI / PANELS		cod. BOWPA	
Altezza / Height	Laccati Opachi / Matt Lacquered	Laccati Speciali/ Special Lacquered	
	€/ml	€/ml	
0 > 50	<b>545</b>	<b>633</b>	
50,1 > 100	<b>843</b>	<b>1007</b>	
100,1 > 150	<b>1141</b>	<b>1381</b>	
150,1 > 200	<b>1439</b>	<b>1755</b>	
200,1 > 250	<b>1738</b>	<b>2129</b>	
250,1 > 280	<b>1917</b>	<b>2353</b>	

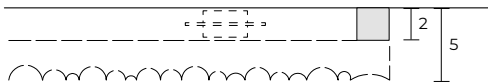

ELEMENTI DI CHIUSURA / CLOSING ELEMENTS		cod. ELECHI	
Finiture / Finishes	€/ml		
Laccati / Lacquered	<b>78</b>		
Laccati Speciali / Special Lacquered	<b>87</b>		

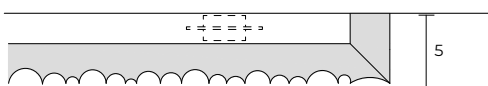

TERMINALE DA 4,5 cm / 4,5 cm TERMINAL		cod. TERM45	
Finiture / Finishes	€/ml		
Laccati / Lacquered	<b>81</b>		
Laccati Speciali / Special Lacquered	<b>87</b>		

TERMINALE CON TAGLIO A 45° / TERMINAL CUT AT 45°		cod. TERT45	
Taglio / Cut	<b>80 € cad/each</b>		

# ELEMENTI EXTRA **WAVE**

## EXTRA ELEMENTS

### PREDISPOSIZIONI PER STAFFA PORTA TV / SET UP FOR TV STAND BRACKET

cod. PREDST

Vano / Compartement

220 €/ml

### PREDISPOSIZIONE PER PRESE O INTERRUTTORI / SET UP FOR SOCKETS OR SWITCHES

cod. PREDPI

Presa o interruttore / Socket or switch

90 € cad/each

### PREDISPOSIZIONE PER VANO DI AERAZIONE / SET UP FOR VENTILATION

cod. PREVAE

Vano di aerazione / Open space

**A RICHIESTA PREVIA VERIFICA DI FATTIBILITA' / ON REQUEST AFTER FEASIBILITY CHECK**

### PANNELLO ISPEZIONABILE REMOVIBILE / REMOVABLE INSPECTIONABLE PANEL

cod. PANISP

Pannello / Panel

400 € cad/each

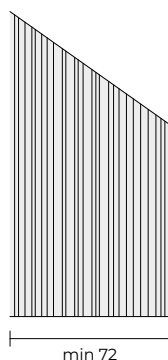

### PREDISPOSIZIONE PER SOFFITTO INCLINATO / SET UP FOR INCLINED CEILING (MIN. 72 CM)

cod. PRESIN

Soffitto inclinato / Inclined ceiling

150 €/ml

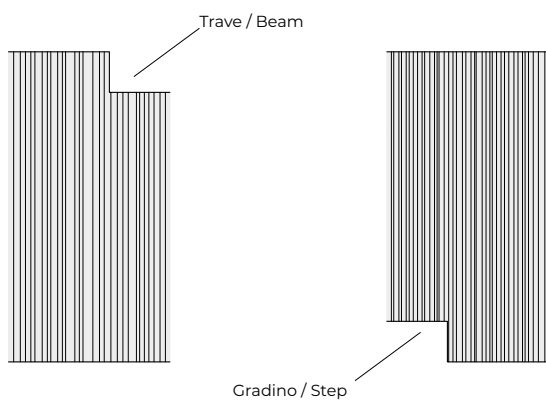

### PREDISPOSIZIONE PER TAGLIO TRAVE O GRADINO / SET UP FOR BEAM OR STEP CUTTING

cod. PRETRG

Trave o gradino / Beam or step

70 € cad/each

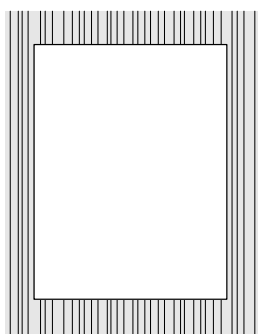

### PREDISPOSIZIONE PER FINESTRA / SET UP FOR WINDOW

cod. PREFIN

Pannello / Panel

400 € cad/each

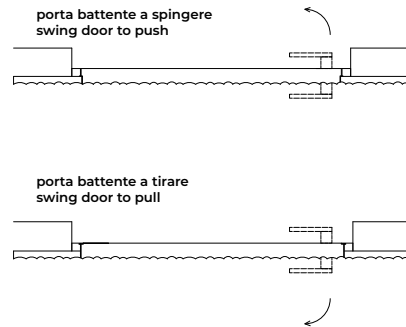
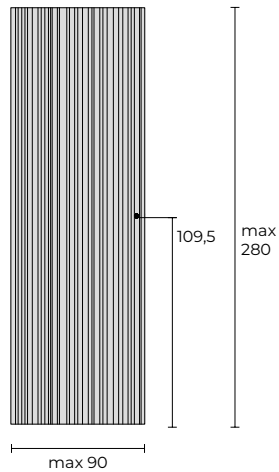

PORTE BATTENTI / SWING DOORS		cod. BOWBT	
Larghezza / Width	Altezza / Height	Laccati Opachi / Matt Lacquered	Laccati Speciali / Special Lacquered
70	0 > 210	<b>2010</b>	<b>2304</b>
80	0 > 210	<b>2154</b>	<b>2674</b>
90	0 > 210	<b>2297</b>	<b>2872</b>
70	210,1 > 240	<b>2238</b>	<b>2574</b>
80	210,1 > 240	<b>2400</b>	<b>2783</b>
90	210,1 > 240	<b>2562</b>	<b>2993</b>
70	240,1 > 280	<b>2983</b>	<b>3395</b>
80	240,1 > 280	<b>3042</b>	<b>3489</b>
90	240,1 > 280	<b>3136</b>	<b>3638</b>

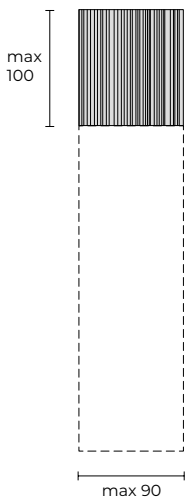

SOPRAPORTA / OVERDOOR		cod. BOWSO	
Larghezza / Length	Altezza / Height	Laccati Opachi / Matt Lacquered	Laccati Speciali / Special Lacquered
		€/ml	€/ml
70	0 > 40	<b>376</b>	<b>612</b>
80	0 > 40	<b>430</b>	<b>699</b>
90	0 > 40	<b>484</b>	<b>787</b>
70	40,1 > 60	<b>564</b>	<b>918</b>
80	40,1 > 60	<b>645</b>	<b>1049</b>
90	40,1 > 60	<b>726</b>	<b>1180</b>
70	60,1 > 100	<b>940</b>	<b>1530</b>
80	60,1 > 100	<b>1074</b>	<b>1749</b>
90	60,1 > 100	<b>1208</b>	<b>1968</b>

## PORTE A BILICO **WAVE** PIVOT DOORS

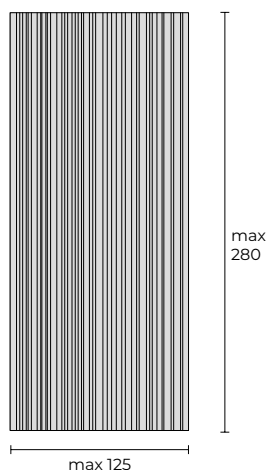

### PORTA A BILICO MONOFACCIALE / SINGLE SIDED PIVOT DOOR

cod. BOWBI

Larghezza / Width	Altezza / Height	Laccati Opachi / Matt Lacquered	Laccati Speciali / Special Lacquered
80 > 100	0 > 240	<b>2740</b>	<b>3048</b>
100,1 > 125	0 > 240	<b>3308</b>	<b>3692</b>
80 > 100	240,1 > 280	<b>3144</b>	<b>3502</b>
100,1 > 125	240,1 > 280	<b>3805</b>	<b>4253</b>

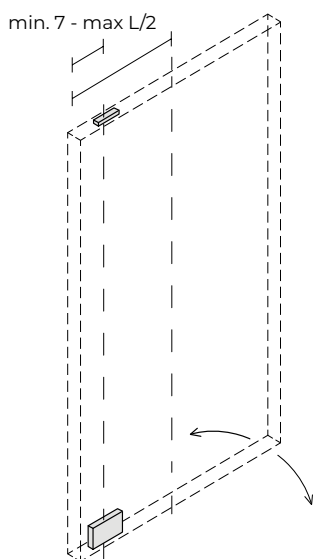

### ELEMENTI / ELEMENTS

cod. SISTPI

#### Descrizione / Description

Cerniera per sistema a bilico per porte fino a 500 kg / Hinge for pivot system for doors up to 500 kg

**1400 €\***

\*costi già al netto di sconto / already discounted costs

### SUPPLEMENTI / SUPPLEMENTS

Battuta per apertura monodirezionale / Stop for one-way opening - cod. STIBDI

**400 €**

# ANTE BATTENTI E ANTE A LIBRO PER PORTALI **WAVE**

## HINGED DOORS AND FOLDING DOORS FOR PORTALS

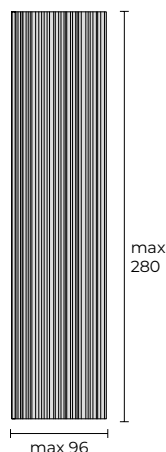

### ANTE BATTENTI / HINGED DOOR

cod. BOWBL

Larghezza / Width	Altezza / Height	Laccati Opachi / Matt Lacquered	Laccati Speciali / Special Lacquered
48 > 72	0 > 250	<b>1994</b>	<b>2257</b>
72,1 > 96	0 > 250	<b>2510</b>	<b>2860</b>
48 > 72	250,1 > 280	<b>2276</b>	<b>2582</b>
72,1 > 96	250,1 > 280	<b>2876</b>	<b>3285</b>

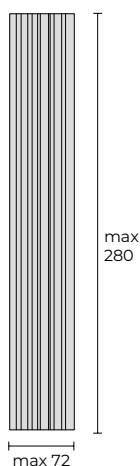

### ANTE A LIBRO / FOLDING DOORS

cod. BOWBL

Larghezza / Width	Altezza / Height	Laccati Opachi / Matt Lacquered	Laccati Speciali / Special Lacquered
48 > 72	0 > 250	<b>1993</b>	<b>2256</b>
48 > 72	250,1 > 280	<b>2275</b>	<b>2582</b>

### SUPPLEMENTI / SUPPLEMENTS

Maniglia / Handle

**60 €**

# PORTALI E MECCANISMI **WAVE**

## PORTALS AND MECHANISMS

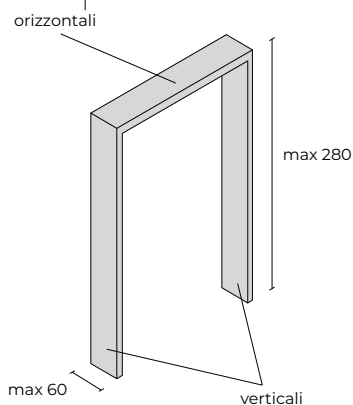

### PORTALI VERTICALI / VERTICAL PORTALS

cod. BOWPO

Profondità / Depth	Altezza / Height	Laccato Opaco e Legni / Matt Lacquered and Woods	Laccati Speciali e Legni Speciali / Special Lacquered and Special Woods
12	100 > 280	<b>180</b>	<b>234</b>
25	100 > 280	<b>360</b>	<b>468</b>
45	100 > 280	<b>600</b>	<b>780</b>
60	100 > 280	<b>864</b>	<b>1132</b>

### PORTALI ORIZZONTALI / HORIZONTAL PORTALS

cod. BOWPO

Profondità / Depth	Laccato Opaco e Legni / Matt Lacquered and Woods	Laccati Speciali e Legni Speciali / Special Lacquered and Special Woods
	€/ml	€/ml
12	<b>72</b>	<b>94</b>
25	<b>144</b>	<b>187</b>
45	<b>240</b>	<b>312</b>
60	<b>345</b>	<b>449</b>

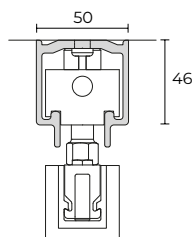

### BINARIO PER ANTE A LIBRO / RAIL FOR FOLDING DOORS

cod. BINALI

Lunghezza / Length	€
100 > 150	<b>120*</b>
150,1 > 210	<b>187*</b>
210,1 > 288	<b>260*</b>

### KIT PER MECCANISMO DI CHIUSURA / CLOSING MECHANISM KIT

cod. KITCAR

Lunghezza / Length	€
100 > 150	<b>488*</b>
150,1 > 210	<b>1300*</b>
210,1 > 288	<b>1460*</b>

\*costi già al netto di sconto  
\*already discounted costs

# KIT DI ILLUMINAZIONE **WAVE** LED LIGHTING KIT

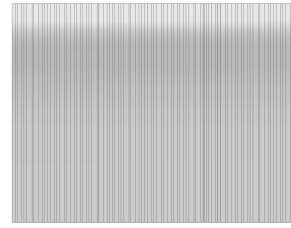
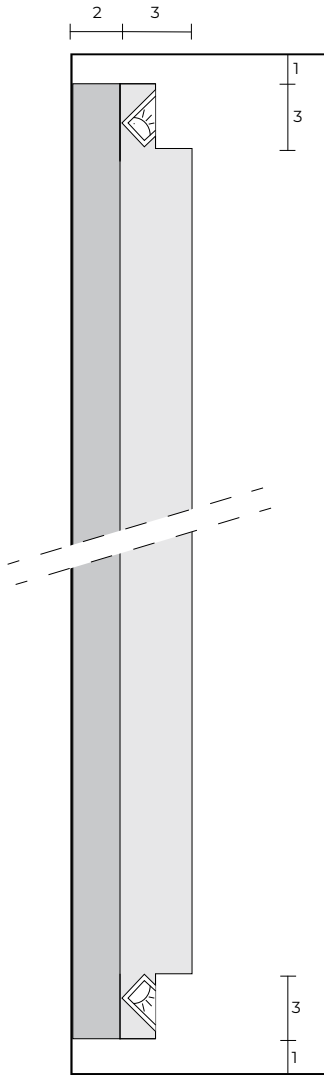

led superiore  
upper led

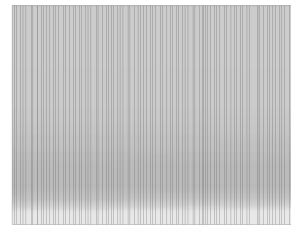

led inferiore  
lower led

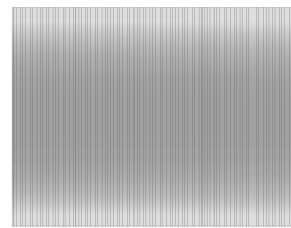

led superiore e inferiore  
upper and lower led

Kit di illuminazione a led composto da stripes led e da un alimentatore  
I led sono alloggiati all'interno di una canalina in alluminio.  
Temperatura led 3000° K.  
Led lighting kit consisting of led stripes and a transformer  
The leds are housed inside an aluminum profile.  
3000° K.

## BARRE A LED ORIZZONTALI / HORIZONTAL STRIP LED

cod. LEDORI

Led superiore / Upper Led	<b>190 €/ml</b>
Led inferiore / Lower Led	<b>190 €/ml</b>
Led superiore e inferiore / Upper and lower Led	<b>380 €/ml</b>
Trasformatore (max 3 metr) / Transformer (max 3 meters)	<b>compreso / included</b>







CARVEL

## INFO TECNICHE CARVEL DATA SHEETS

Una boiserie come ricerca di un'estetica modulare in cui il legno e la sue venature potessero esprimersi rendendo l'ambiente ricco di dettagli disegnati dalla natura. Storicamente uno dei manufatti che ha utilizzato il legno come materiale strutturale dal sicuro fascino senza tempo sono state le imbarcazioni in legno. La ripetizione ed il susseguirsi di venature diverse in tavole regolari e precise o tagliate in senso sfalsato mi ha sempre portato a considerarlo un oggetto trattato da mani esperte, in cui il connubio natura e prodotto fosse ai massimi livelli di espressione. Da questa immagine di naturale bellezza proviene l'ispirazione di disegnare la boiserie; come se fosse una paratia o un decking di un'imbarcazione, che grazie alle sue tavole, regala un impatto visivo ricco di dettaglio e naturalezza. E' una boiserie in cui il montante è la base del sistema, a cui sono applicati i pannelli inclinati di diverse larghezze e altezze.

Wall paneling as a search for a modular aesthetic in which the wood and its grain could express themselves, making the environment rich in details designed by nature. Historically, one of the artifacts that used wood as a structural material with a sure timeless charm were wooden boats. The repetition and the succession of different veins in regular and precise boards or cut in a staggered direction has always led me to consider it an object treated by expert hands, in which the combination of nature and product was at the highest levels of expression. The inspiration to design the wall paneling comes from this image of natural beauty; as if it were a bulkhead or a decking of a boat, which thanks to its boards, gives a visual impact rich in detail and naturalness. It's a wall paneling whose jamb is the basis of the system to which inclined panels of different widths and heights are applied.

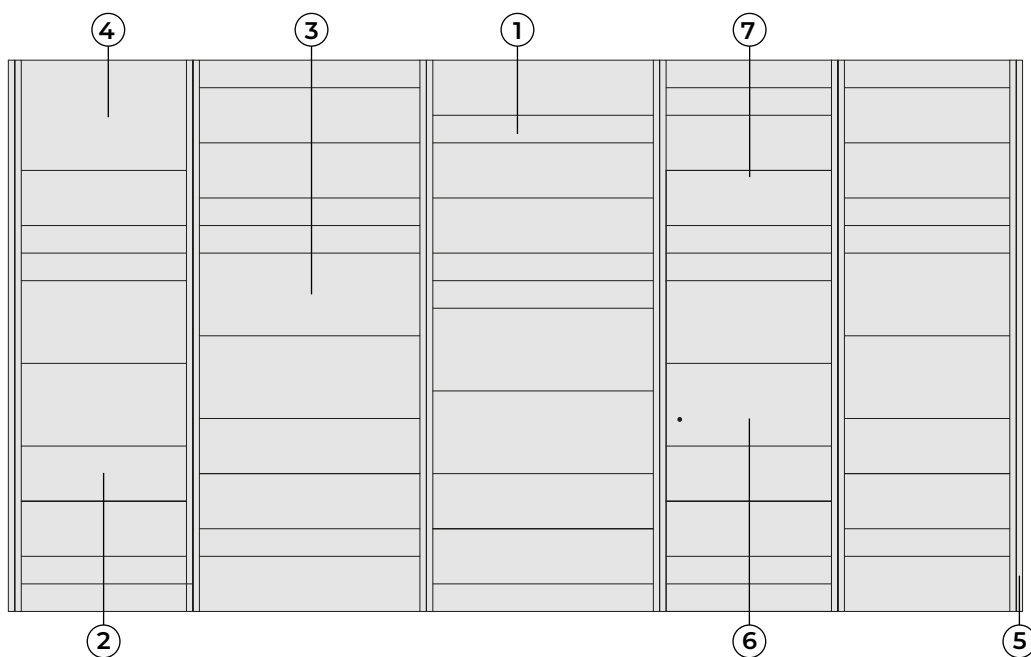

### ELEMENTI / ELEMENTS

1. Pannello h. 15 / Panel h. 15 - pag. 50

2. Pannello h. 30 / Panel h. 30 - pag. 50

3. Pannello h. 45 / Panel h. 45 - pag. 50

4. Pannello h. 60 / Panel h. 60 - pag. 50

5. Montante / Upright - pag. 50

6. Porta / Door - pag. 51

7. Sopraporta / Overdoor - pag. 51

### LEGNI / WOOD



Canaletto



Rovere



Rovere Grigio



Rovere TT

### LEGNI SPECIALI / SPECIAL WOOD



Sand



Lava

### LACCATI OPACHI / MATT LACQUERED



Neve



Corda



Fango



Tabacco



Caffè



Grigio



Antracite



Nero

### LACCATI SPECIALI / SPECIAL LACQUERED



Bronzo



Piombo



Argento



Oro

ESEMPIO 1 / EXAMPLE 1

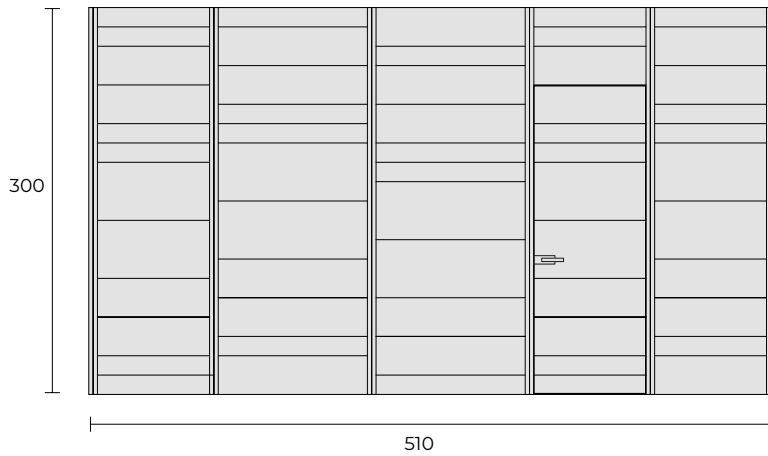

CONFIGURAZIONE / CONFIGURATION

- |                            |                       |
|----------------------------|-----------------------|
| n. 6 montanti h. 300       | n. 6 uprights h. 300  |
| n. 16 pannelli 90x15       | n. 16 panels 90x15    |
| n. 13 pannelli 90x30       | n. 13 panels 90x30    |
| n. 6 pannelli 90x45        | n. 6 panels 90x45     |
| n. 8 pannelli 120x15       | n. 8 panels 120x15    |
| n. 10 pannelli 120x30      | n. 10 panels 120x30   |
| n. 4 pannelli 120x45       | n. 4 panels 120x45    |
| n. 1 porta battente 90x240 | n. 1 wing door 90x240 |
| n. 1 sopra porta 90x60     | n. 1 xxxxxxxx 90x60   |
| n. 1 maniglia              | n. 1 handle           |

ESEMPIO 2 / EXAMPLE 2

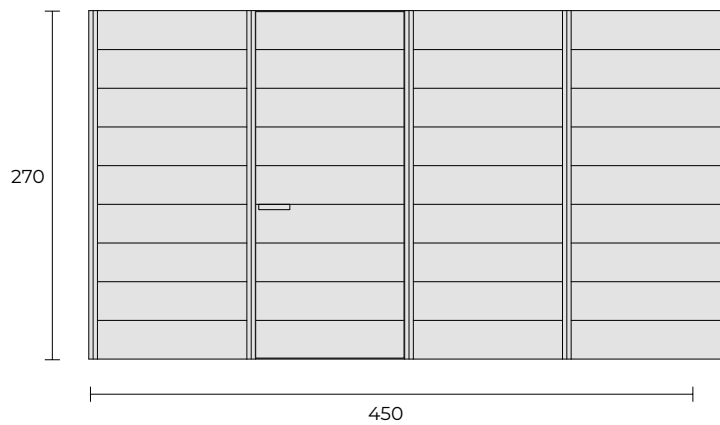

CONFIGURAZIONE / CONFIGURATION

- |                                  |                             |
|----------------------------------|-----------------------------|
| n. 5 montanti h. 270             | n. 5 uprights h. 270        |
| n. 36 pannelli 120x30            | n. 36 panels 120x30         |
| n. 1 porta a battente 90x270     | n. 1 swing door 90x270      |
| n. 1 cerniera per porta a bilico | n. 1 hinge for pivot system |
| n. 1 maniglia                    | n. 1 handle                 |

ESEMPIO 3 / EXAMPLE 3

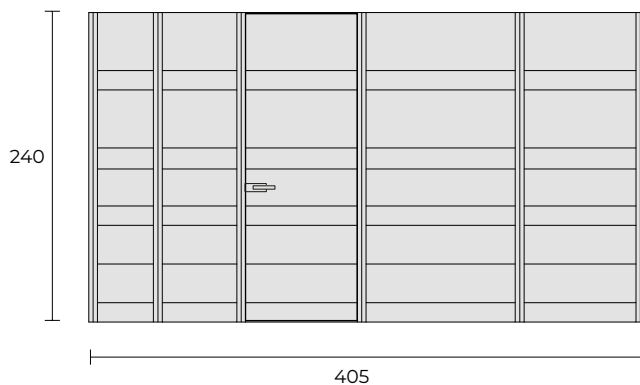

CONFIGURAZIONE / CONFIGURATION

- |                            |                        |
|----------------------------|------------------------|
| n. 6 montanti h. 240       | n. 6 uprights h. 240   |
| n. 4 pannelli 45x15        | n. 4 panels 45x15      |
| n. 3 pannelli 45x30        | n. 3 panels 45x30      |
| n. 2 pannelli 45x45        | n. 2 panels 45x45      |
| n. 4 pannelli 60x15        | n. 4 panels 60x15      |
| n. 3 pannelli 60x30        | n. 3 panels 60x30      |
| n. 2 pannelli 60x45        | n. 2 panels 60x45      |
| n. 8 pannelli 90x15        | n. 8 panels 90x15      |
| n. 6 pannelli 90x30        | n. 6 panels 90x30      |
| n. 4 pannelli 90x45        | n. 4 panels 90x45      |
| n. 4 pannelli 120x15       | n. 4 panels 120x15     |
| n. 3 pannelli 120x30       | n. 3 panels 120x30     |
| n. 2 pannelli 120x45       | n. 2 panels 120x45     |
| n. 1 porta battente 90x240 | n. 1 swing door 90x240 |
| n. 1 maniglia              | n. 1 handle            |

# PANNELLI ORIZZONTALI E MONTANTI CARVEL

## HORIZONTAL PANELS AND UPRIGHTS

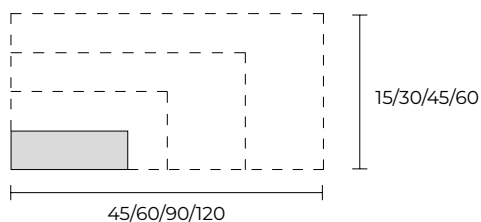

### Finiture pannelli / Panels finishes

Cat. A - Laccati Opachi, Legni\* / Matt Lacquered, Wood\*

Cat. B - Laccati Speciali, Legni Speciali\* / Special Lacquered, Special Wood\*

\* Fornito di serie con venatura verticale / Supplied with vertical veining

### PANNELLI ORIZZONTALI / HORIZONTAL PANELS cod. BOCPA

Larghezza / Width	Altezza / Height	Finiture / Finishes	
		A	B
45	15	<b>89</b>	<b>99</b>
	30	<b>111</b>	<b>131</b>
	45	<b>132</b>	<b>162</b>
	60	<b>168</b>	<b>208</b>
60	15	<b>98</b>	<b>111</b>
	30	<b>126</b>	<b>152</b>
	45	<b>168</b>	<b>208</b>
	60	<b>195</b>	<b>249</b>
90	15	<b>142</b>	<b>162</b>
	30	<b>182</b>	<b>222</b>
	45	<b>244</b>	<b>304</b>
	60	<b>284</b>	<b>364</b>
120	15	<b>174</b>	<b>200</b>
	30	<b>277</b>	<b>280</b>
	45	<b>308</b>	<b>388</b>
	60	<b>361</b>	<b>468</b>

### SUPPLEMENTI / SUPPLEMENTS

Taglio in larghezza / Width cut - cod. TAGLAR

a richiesta / on demand

Taglio in altezza / Height cut - cod. TAGALT

a richiesta / on demand

### MONTANTI / UPRIGHTS

cod. MONTVE

Altezza / Height	Finiture / Finishes	
	A	B
0 >100	<b>100</b>	<b>120</b>
100,1 > 150	<b>150</b>	<b>180</b>
150,1 > 220	<b>220</b>	<b>260</b>
220,1 > 250	<b>250</b>	<b>300</b>
250,1 > 270	<b>280</b>	<b>324</b>
270,1 > 300	<b>315</b>	<b>360</b>

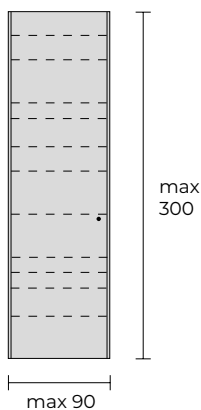

**Finiture porte / Doors finishes**

Cat. A - Laccati Opachi, Legni\* / Matt Lacquered, Wood\*

Cat. B - Laccati Speciali, Legni Speciali\* / Special Lacquered, Special Wood\*

\* Fornito di serie con venatura verticale / Supplied with vertical veining

PORTE BATTENTI / SWING DOORS		cod. BOCBT	
Larghezza / Width	Altezza / Height	Finiture / Finishes	
		A	B
70	0 > 210	<b>1538</b>	<b>1847</b>
80	0 > 210	<b>1623</b>	<b>1948</b>
90	0 > 210	<b>1707</b>	<b>2048</b>
70	210,1 > 260	<b>1741</b>	<b>2089</b>
80	210,1 > 260	<b>1833</b>	<b>2200</b>
90	210,1 > 260	<b>1933</b>	<b>2320</b>
70	260,1 > 300	<b>1912</b>	<b>2295</b>
80	260,1 > 300	<b>2020</b>	<b>2424</b>
90	260,1 > 300	<b>2127</b>	<b>2552</b>

**NOTE:** per completare la porta aggiungere il costo dei pannelli da 90cm / **NOTES:** to complete the door, add the cost of the 90cm panels.

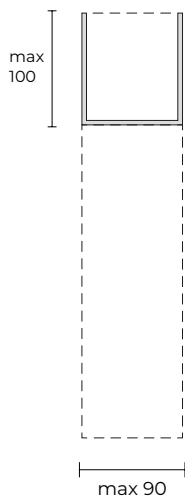

**Finiture porte / Doors finishes**

Cat. A - Laccati Opachi, Legni\* / Matt Lacquered, Wood\*

Cat. B - Laccati Speciali, Legni Speciali\* / Special Lacquered, Special Wood\*

\* Fornito di serie con venatura verticale / Supplied with vertical veining

SOPRA PORTA / OVERDOOR		cod. BOCSO		
Larghezza / Width	Altezza / Height	Finiture / Finishes		
		A	B	C
70	0 > 40	<b>239</b>	<b>266</b>	<b>293</b>
80	0 > 40	<b>250</b>	<b>281</b>	<b>312</b>
90	0 > 40	<b>271</b>	<b>306</b>	<b>341</b>
70	40,1 > 60	<b>339</b>	<b>385</b>	<b>431</b>
80	40,1 > 60	<b>358</b>	<b>410</b>	<b>462</b>
90	40,1 > 60	<b>391</b>	<b>449</b>	<b>507</b>
70	60,1 > 100	<b>565</b>	<b>642</b>	<b>719</b>
80	60,1 > 100	<b>597</b>	<b>684</b>	<b>770</b>
90	60,1 > 100	<b>652</b>	<b>748</b>	<b>845</b>

**NOTE:** per completare la porta aggiungere il costo dei pannelli da 90cm / **NOTES:** to complete the door, add the cost of the 90cm panels.





**MOBILI SOSPESI**  
**HANGING UNITS**

# MOBILI SOSPESI DOGA, SINGLY, WAVE HANGING UNITS

Strutture e cassetti realizzati in nobilitato. Piano, fianchi e frontali cassetti realizzati in legno/vetro. Apertura a push.

Structures and drawers made of melamine. Top, side and front of the drawers made of wood/glass. Push opening.

## VETRI LACCATI / LACQUERED GLASS

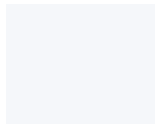

Glass Neve  
Glass Neve Acidato



Glass Corda  
Glass Corda Acidato



Glass Fango  
Glass Fango Acidato



Glass Tabacco  
Glass Tabacco Acidato

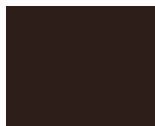

Glass Caffè  
Glass Caffè Acidato



Glass Grigio  
Glass Grigio Acidato



Glass Antracite  
Glass Antracite Acidato

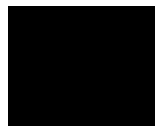

Glass Nero  
Glass Nero Acidato

## VETRI LACCATI SPECIALI / SPECIAL LACQUERED GLASS

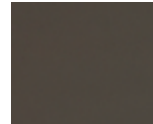

Glass Bronzo  
Glass Bronzo Acidato



Glass Piombo  
Glass Piombo Acidato



Glass Oro  
Glass Oro Acidato



Glass Argento  
Glass Argento Acidato

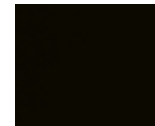

Glass Grafite  
Glass Grafite Acidato



Glass Platino  
Glass Platino Acidato

## METALLI / METALS



Anodizzato Titanio



Anodizzato Bronzo Scuro

## GRES PORCELLANATO / PORCELAIN STONEWARE



Shard



Diamond

## VETRI / GLASS



Specchio

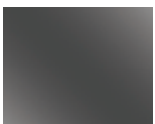

Specchio Fumo



Specchio Ambra



Stopsol



Stopsol Fumo



Stopsol Ambra



# MOBILI SOSPESI DOGA, SINGLY, WAVE HANGING UNITS

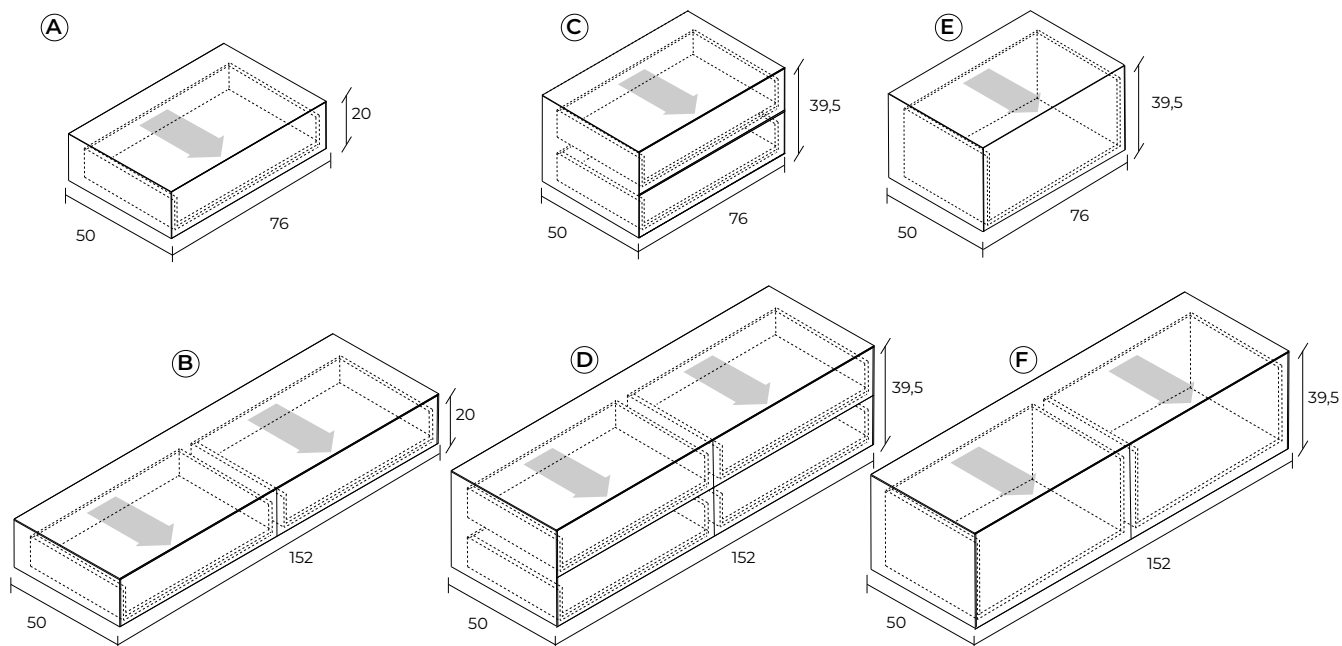

## MOBILE SOSPESO CON CASSETTI / HANGING UNIT WITH DRAWERS

cod. MOBSO

	Larghezza Width	Altezza Height	Tipologia Typology	Laccati Opachi	Laccati Speciali	Legni	Legni Speciali
A	76	20	1 cassetto 1 drawer	<b>1963</b>	<b>2395</b>	<b>2258</b>	<b>2754</b>
B	152	20	2 cassetti 2 drawers	<b>2655</b>	<b>3239</b>	<b>3053</b>	<b>3725</b>
C	76	40	2 cassetti 2 drawers	<b>2359</b>	<b>2878</b>	<b>2713</b>	<b>3310</b>
D	152	40	4 cassetti 4 drawers	<b>3448</b>	<b>4207</b>	<b>3965</b>	<b>4838</b>
E	76	40	1 cassettone 1 high drawer	<b>2133</b>	<b>2602</b>	<b>2453</b>	<b>2993</b>
F	152	40	2 cassettoni 2 high drawers	<b>2996</b>	<b>3655</b>	<b>3445</b>	<b>4203</b>

## MOBILE SOSPESO CON CASSETTI / HANGING UNIT WITH DRAWERS

cod. MOBSO

	Larghezza Width	Altezza Height	Tipologia Typology	Vetri	Vetri laccati	Vetri laccati speciali	Grés porcellanato
A	76	20	1 cassetto 1 drawer	<b>1897</b>	<b>2253</b>	<b>2491</b>	<b>2465</b>
B	152	20	2 cassetti 2 drawers	<b>2523</b>	<b>3237</b>	<b>3711</b>	<b>3659</b>
C	76	40	2 cassetti 2 drawers	<b>2267</b>	<b>2764</b>	<b>3096</b>	<b>3059</b>
D	152	40	4 cassetti 4 drawers	<b>3263</b>	<b>4257</b>	<b>4920</b>	<b>4847</b>
E	76	40	1 cassettone 1 high drawer	<b>2041</b>	<b>2539</b>	<b>2870</b>	<b>2834</b>
F	152	40	2 cassettoni 2 high drawers	<b>2813</b>	<b>3808</b>	<b>4471</b>	<b>4397</b>

**NOTE:** cassetto interno in nobilitato in abbinamento alla finitura esterna.

**NOTES:** internal drawer in melamine in combination with the external finish.

# MOBILI SOSPESI DOGA, SINGLY, WAVE HANGING UNITS

apertura a ribalta  
flap opening

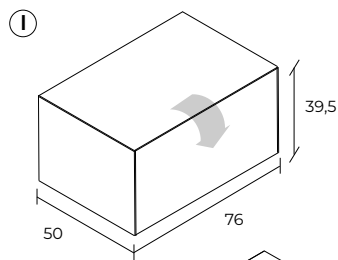
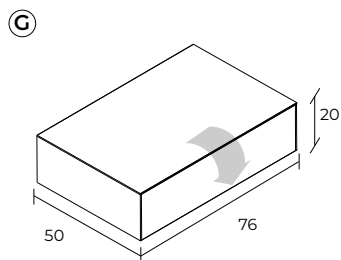

apertura a ribalta  
flap opening

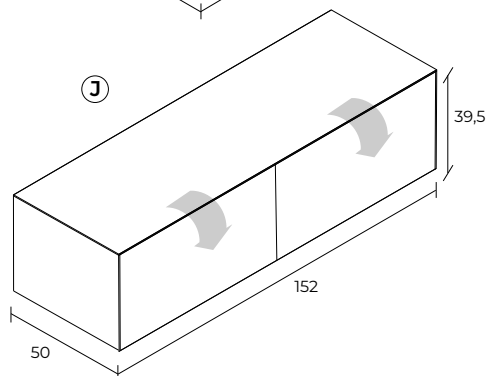
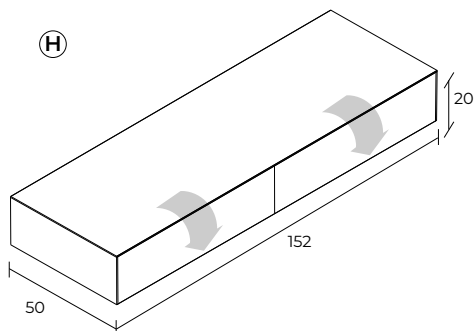

## MOBILE SOSPESO CON ANTE A RIBALTA / HANGING UNIT WITH FLAP DOOR cod. MOBSO

	Larghezza Width	Altezza Height	Tipologia Tipology	Laccati opachi	Laccati speciali	Legni	Legni speciali
Ⓒ	76	20	anta a ribalta flap door	<b>2023</b>	<b>2468</b>	<b>2326</b>	<b>2838</b>
Ⓗ	152	20	ante a ribalta flap doors	<b>2775</b>	<b>3385</b>	<b>3191</b>	<b>3893</b>
Ⓘ	76	40	anta a ribalta flap door	<b>2194</b>	<b>2677</b>	<b>2523</b>	<b>3078</b>
Ⓙ	152	40	ante a ribalta flap doors	<b>3117</b>	<b>3803</b>	<b>3586</b>	<b>4373</b>

## MOBILE SOSPESO CON ANTE A RIBALTA / HANGING UNIT WITH FLAP DOOR cod. MOBSO

	Larghezza Width	Altezza Height	Tipologia Tipology	Vetri	Vetri laccati	Vetri laccati speciali	Grés porcellanato
Ⓒ	76	20	anta a ribalta flap door	<b>1956</b>	<b>2314</b>	<b>2552</b>	<b>2525</b>
Ⓗ	152	20	ante a ribalta flap doors	<b>2643</b>	<b>3357</b>	<b>3832</b>	<b>3779</b>
Ⓘ	76	40	anta a ribalta flap door	<b>2102</b>	<b>2599</b>	<b>2930</b>	<b>2894</b>
Ⓙ	152	40	ante a ribalta flap doors	<b>2933</b>	<b>3927</b>	<b>4590</b>	<b>4517</b>

# MOBILI SOSPESI DOGA, SINGLY, WAVE HANGING UNITS

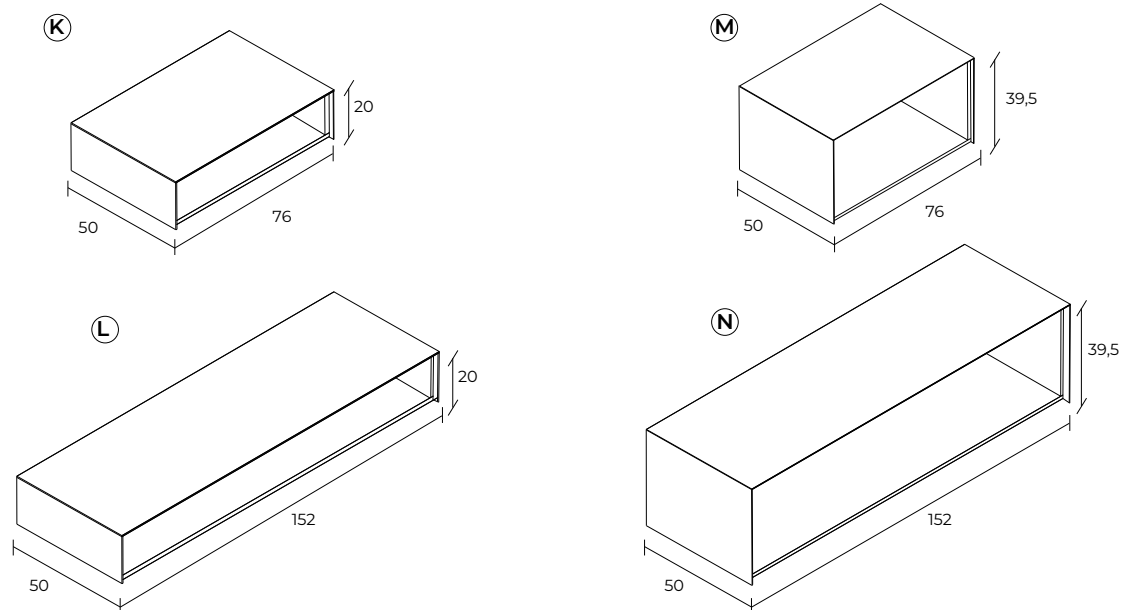

MOBILE SOSPESO A GIORNO / OPEN HANGING UNIT							cod. MOBSO
	Larghezza Width	Altezza Height	Tipologia Typology	Laccati opachi	Laccati speciali	Legni	Legni speciali
Ⓚ	76	20	vano a giorno open box	<b>1947</b>	<b>2375</b>	<b>2239</b>	<b>2731</b>
Ⓛ	152	20	vano a giorno open box	<b>2525</b>	<b>3080</b>	<b>2904</b>	<b>3542</b>
Ⓜ	76	40	vano a giorno open box	<b>2128</b>	<b>2596</b>	<b>2447</b>	<b>2985</b>
Ⓝ	152	40	vano a giorno open box	<b>2787</b>	<b>3400</b>	<b>3205</b>	<b>3910</b>

MOBILE SOSPESO / HANGING UNIT							cod. MOBSO
	Larghezza Width	Altezza Height	Tipologia Typology	Vetri	Vetri laccati	Vetri laccati speciali	Grés porcellanato
Ⓚ	76	20	vano a giorno open box	<b>1516</b>	<b>2002</b>	<b>2327</b>	<b>2328</b>
Ⓛ	152	20	vano a giorno open box	<b>1898</b>	<b>2168</b>	<b>2705</b>	<b>2710</b>
Ⓜ	76	40	vano a giorno open box	<b>2068</b>	<b>2394</b>	<b>2609</b>	<b>2586</b>
Ⓝ	152	40	vano a giorno open box	<b>2687</b>	<b>3228</b>	<b>3588</b>	<b>3548</b>

# MOBILI SOSPESI DOGA, SINGLY, WAVE HANGING UNITS

apertura a ribalta  
flap opening

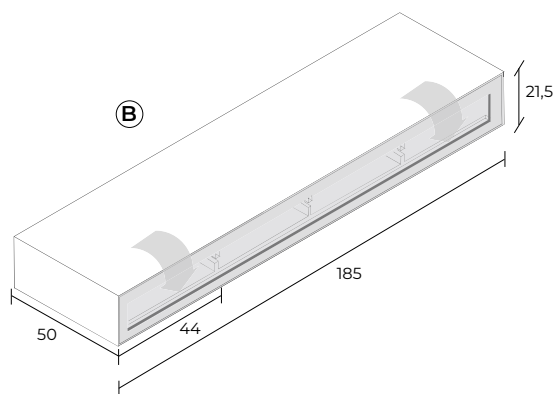
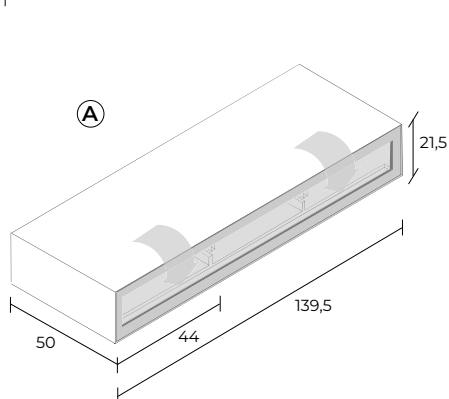

## UNITÀ SOSPESA PER TV / TV HANGING CABINET

cod. MOBSO

Tipologia Typology	Vetri laccati Lacquered glasses	Vetri acidati laccati Acidated lacquered glasses	Laccati opachi / Essenza di serie Matt Lacquered covered / Standard finishing
Ⓐ unità sospesa a 3 vani 3 unit hanging cabinet	1430	1534	1287
Ⓑ unità sospesa a 4 vani 4 unit hanging cabinet	1677	1781	1508

**NOTE**  
Carico massimo consentito: 80kg.  
Maximum possible weight on the cabinet: 80 kg.

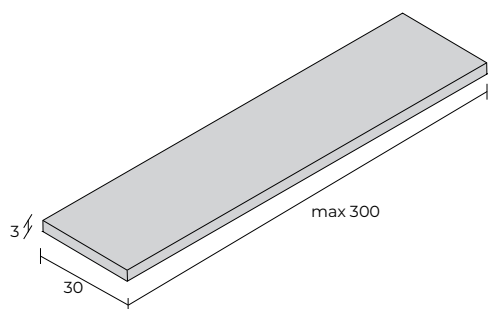

Mensola in HDF. Carico massimo distribuito consentito: **30 kg/ml**.  
Shelf in HDF. Maximum distributed load allowed: **30 kg/ml**.

## MENSOLA / SHELF

cod. MOBME

	Laccati Opachi e Legni €/ml	Laccati Speciali e Legni Speciali €/ml
Mensola / Shelf	507	507



LEVIA

Sistema di ante costituite da un telaio perimetrale in alluminio e da due pannelli in diverse finiture. Nella versione battente sono incluse la serratura magnetica e cerniere a scomparsa regolabili sui 3 assi. Le versioni a scomparsa e scorrevole sono comprese di maniglia incassata.

Door system consisting of an aluminum perimeter frame and two panels in different finishes. The swing version includes the magnetic lock and 3-axis adjustable concealed hinges. The pocket and sliding versions include a built-in handle.

## DIMENSIONI ANTE DOORS DIMENSIONS

### BATTENTE / SWING

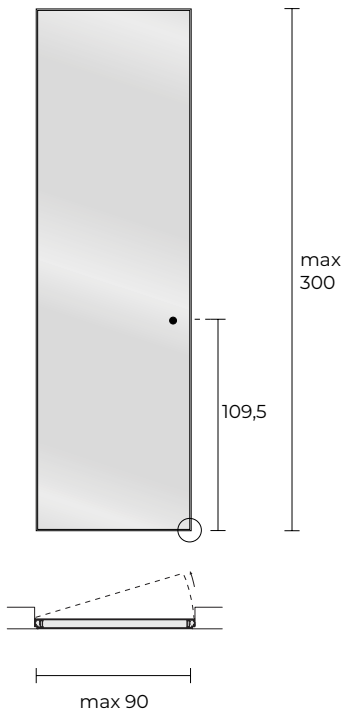

### A SCOMPARSA / POCKET DOOR

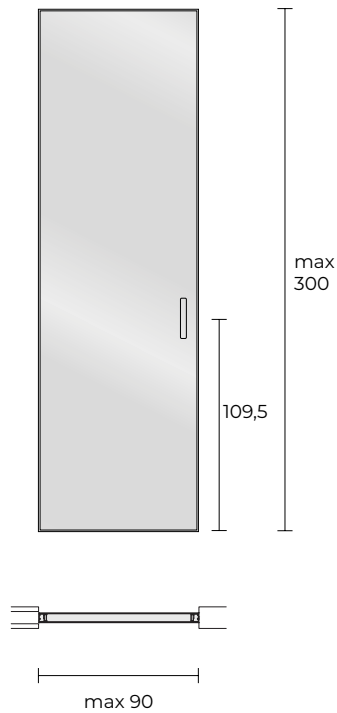

### SCORREVOLE / SLIDING DOOR

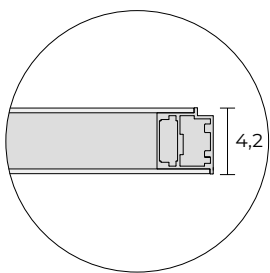
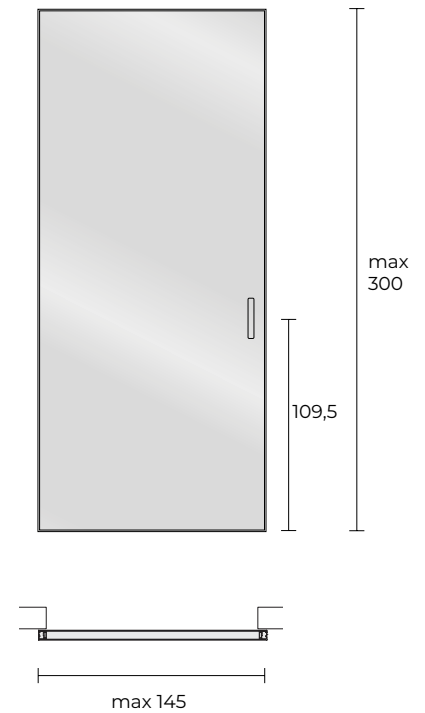

dettaglio sezione  
section detail

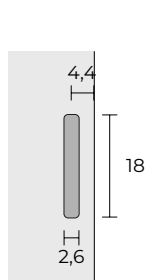

maniglia incassata Levia  
Levia built-in handle

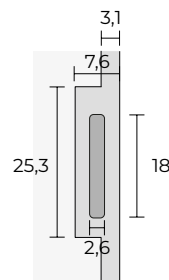

maniglia incassata Levia Frame  
Levia Frame built-in handle

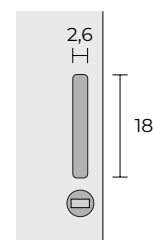

maniglia con blocco di chiusura  
handle with locking system

## ABBINAMENTI CON STIPITI, MECCANISMI E BINARI (da pag. 103 a pag. 118) MATCHING WITH JAMBS, MECHANISMS AND RAILS (from pag. 103 to pag. 118)

ANTA BATTENTE / SWING DOOR	ANTA A SCOMPARSA / POCKET DOOR	ANTA SCORREVOLE / SLIDING DOOR
Stipite immurato / Built-in door jamb	Filo Muro (tipologia Essential® o Syntesis Line®)	Binari / Rails
Tira_Spingi	Stipite Arc / Arc door jamb	
Stipite Arc / Arc door jamb	Stipite Basic / Basic door jamb	
Stipite Basic / Basic door jamb		

**VETRI / GLASS**



**VETRI LACCATI / LACQUERED GLASS**



**VETRI LACCATI SPECIALI / SPECIAL LACQUERED GLASS**



**LACCATI OPACHI / MATT LACQUERED**



**LACCATI SPECIALI / SPECIAL LACQUERED**



**METALLI / METALS**



**GRES PORCELLANATO / PORCELAIN STONEWARE \***

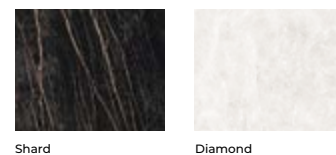

**LEGNI / WOOD**



**LEGNI SPECIALI / SPECIAL WOOD \*\***



I colori sono indicativi / Colors are indicative

\* A richiesta / On request

\*\* Legni a campione previa valutazione / Special wood available upon request

## ANTE BATTENTI LEVIA SWING DOORS

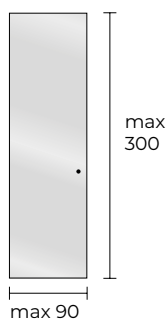

### Finiture pannello / Panel finishes

Cat. A - Specchio, Specchio Fumo, Specchio Ambra, Vetri Laccati / Lacquered Glass

Cat. B - Vetri Laccati Acidati, Laccati Opachi, Legni\* / Lacquered Frosted Glass, Matt Lacquered, Wood\*

Cat. C - Specchi Acidati, Laccati Speciali, Legni Speciali\* / Frosted Mirror, Special Lacquered, Special Wood\*

\* Fornito di serie con venatura verticale / Supplied with vertical veining

### LEVIA - ANTA BATTENTE / SWING DOOR

cod. LEVBT

Larghezza / Width	Altezza / Height	Telaio Anodizzato Titanio o Anodizzato Bronzo Scuro / Anodizzato Titanio or Anodizzato Bronzo Scuro frame		
		Finiture pannello / Panel finishes		
		A	B	C
70	0 > 210	2134	2277	2419
80	0 > 210	2192	2356	2519
90	0 > 210	2251	2435	2619
70	210,1 > 260	2258	2490	2689
80	210,1 > 260	2330	2532	2735
90	210,1 > 260	2402	2630	2858
70	260,1 > 300	2357	2561	2765
80	260,1 > 300	2439	2673	2907
90	260,1 > 300	2522	2784	3049



### Finiture pannello / Panel finishes

Cat. A - Extra, Fumo, Ambra

Cat. B - Acidato, Acidato Fumo, Acidato Ambra

Cat. C - Stopsol, Stopsol Fumo, Stopsol Ambra

### Note /Notes

Vetro con cornice perimetrale retrolaccata Nero.

Glass panel with Nero back-lacquered perimeter frame.

### LEVIA FRAME - ANTA BATTENTE / SWING DOOR

cod. LEVFBT

Larghezza / Width	Altezza / Height	Telaio Anodizzato Titanio o Anodizzato Bronzo Scuro / Anodizzato Titanio or Anodizzato Bronzo Scuro frame		
		Finiture pannello / Panel finishes		
		A	B	C
70	0 > 210	2134	2277	2419
80	0 > 210	2192	2356	2519
90	0 > 210	2251	2435	2619
70	210,1 > 260	2258	2490	2689
80	210,1 > 260	2330	2532	2735
90	210,1 > 260	2402	2630	2858
70	260,1 > 300	2357	2561	2765
80	260,1 > 300	2439	2673	2907
90	260,1 > 300	2522	2784	3049

### SUPPLEMENTI / SUPPLEMENTS

Telaio in laccati opachi / Matt lacquered frame	+ 10%
Telaio in laccati speciali / Special lacquered frame	+ 15%
Telaio in laccati opachi a campione per ordini inferiori alle 5 ante / Custom matt lacquered frame for orders lower than 5 doors	+ 15%
Meccanismo Tira_Spingi per porte di dimensioni massime 90x250 / Tira_Spingi mechanism for doors with maximum dimensions of 90x250	400 €
Battuta per serratura / Strike for lock	a richiesta / on request

PER ANTA DOPPIA RADDOPPIARE IL PREZZO DELL'ANTA SINGOLA / FOR DOUBLE DOOR DOUBLE UP THE PRICE OF THE DOOR



# ANTE A SCOMPARSA LEVIA POCKET DOORS

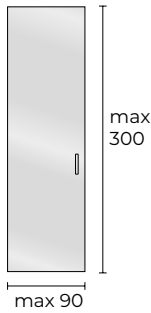

## Finiture pannello / Panel finishes

Cat. A - Extra, Fumo, Ambra

Cat. B - Acidato, Acidato Fumo, Acidato Ambra

Cat. C - Stopsol, Stopsol Fumo, Stopsol Ambra

## Note /Notes

Vetro con cornice perimetrale retrolaccata Nero.

Glass panel with Nero back-lacquered perimeter frame.

## LEVIA - ANTA A SCOMPARSA / POCKET DOOR

cod. LEVSC

Larghezza / Width	Altezza / Height	Telaio Anodizzato Titanio o Anodizzato Bronzo Scuro / Anodizzato Titanio or Anodizzato Bronzo Scuro frame		
		Finiture pannello / Panel finishes		
		A	B	C
75	210	2134	2277	2419
85	210	2192	2356	2519
95	210	2251	2435	2619
75	260	2258	2490	2689
85	260	2330	2532	2735
95	260	2402	2630	2858

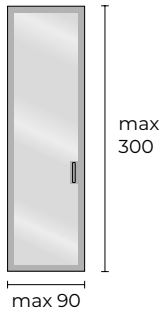

## Finiture pannello / Panel finishes

Cat. A - Extra, Fumo, Ambra

Cat. B - Acidato, Acidato Fumo, Acidato Ambra

Cat. C - Stopsol, Stopsol Fumo, Stopsol Ambra

## Note /Notes

Vetro con cornice perimetrale retrolaccata Nero.

Glass panel with Nero back-lacquered perimeter frame.

## LEVIA FRAME - ANTA A SCOMPARSA / POCKET DOOR

cod. LEVFSC

Larghezza / Width	Altezza / Height	Telaio Anodizzato Titanio o Anodizzato Bronzo Scuro / Anodizzato Titanio or Anodizzato Bronzo Scuro frame		
		Finiture pannello / Panel finishes		
		A	B	C
75	210	2192	2357	2519
85	210	2310	2515	2620
95	210	2427	2674	2720
75	260	2302	2497	2692
85	260	2441	2685	2929
95	260	2579	2873	3166

PER ANTA DOPPIA RADDOPPIARE IL PREZZO DELL'ANTA SINGOLA / FOR DOUBLE DOOR DOUBLE UP THE PRICE OF THE DOOR

## SUPPLEMENTI / SUPPLEMENTS

Telaio in laccati opachi / Matt lacquered frame	+ 10%
Telaio in laccati speciali / Special lacquered frame	+ 15%
Telaio in laccati opachi a campione per ordini inferiori alle 5 ante / Custom matt lacquered frame for orders lower than 5 doors	+ 15%

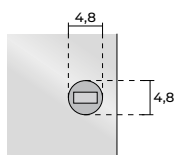

## SUPPLEMENTO BLOCCO CON SISTEMA DI CHIUSURA / SUPPLEMENT DOOR WITH LOCKING DETAIL

cod. SUPBLE

Porte a scomparsa con blocco con sistema di chiusura. La maniglia è posizionata ad un'altezza al centro di 109,5 cm.  
Pocket door with locking detail. The handle is positioned at the middle of 109,5 cm height.

100 €

## ANTE SCORREVOLI LEVIA SLIDING DOORS

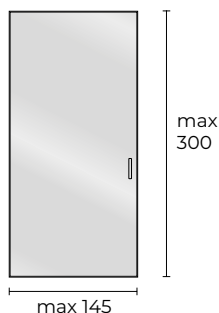

### Finiture pannello / Panel finishes

Cat. A - Specchio, Specchio Fumo, Specchio Ambra, Vetri Laccati / Lacquered Glass  
 Cat. B - Vetri Laccati Acidati, Laccati Opachi, Legni\* / Lacquered Frosted Glass, Matt Lacquered, Wood\*  
 Cat. C - Specchi Acidati, Laccati Speciali, Legni Speciali\* / Frosted Mirror, Special Lacquered, Special Wood\*

\* Fornito di serie con venatura verticale / Supplied with vertical veining

### LEVIA - ANTA SCORREVOLE / SLIDING DOOR

cod. LEVSR

Larghezza / Width	Altezza / Height	Telaio Anodizzato Titanio o Anodizzato Bronzo Scuro / Anodizzato Titanio or Anodizzato Bronzo Scuro frame		
		Finiture pannello / Panel finishes		
		A	B	C
70 > 100	0 > 210	2284	2436	2588
100,1 > 120	0 > 210	2397	2558	2717
120,1 > 145	0 > 210	2517	2686	2853
70 > 100	210,1 > 260	2416	2664	2877
100,1 > 120	210,1 > 260	2536	2797	3020
120,1 > 145	210,1 > 260	2663	2936	3171
70 > 100	260,1 > 300	2570	2814	3058
100,1 > 120	260,1 > 300	2698	2954	3210
120,1 > 145	260,1 > 300	2833	3102	3371

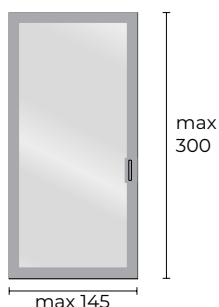

### Finiture pannello / Panel finishes

Cat. A - Specchio, Specchio Fumo, Specchio Ambra, Vetri Laccati / Lacquered Glass  
 Cat. B - Vetri Laccati Acidati, Laccati Opachi, Legni\* / Lacquered Frosted Glass, Matt Lacquered, Wood\*  
 Cat. C - Specchi Acidati, Laccati Speciali, Legni Speciali\* / Frosted Mirror, Special Lacquered, Special Wood\*

\* Fornito di serie con venatura verticale / Supplied with vertical veining

### LEVIA FRAME - ANTA SCORREVOLE / SLIDING DOOR

cod. LEVFSR

Larghezza / Width	Altezza / Height	Telaio Anodizzato Titanio o Anodizzato Bronzo Scuro / Anodizzato Titanio or Anodizzato Bronzo Scuro frame		
		Finiture pannello / Panel finishes		
		A	B	C
70 > 100	0 > 210	2347	2504	2660
100,1 > 120	0 > 210	2465	2629	2793
120,1 > 145	0 > 210	2590	2760	2933
70 > 100	210,1 > 260	2485	2739	2957
100,1 > 120	210,1 > 260	2610	2875	3104
120,1 > 145	210,1 > 260	2740	3019	3260
70 > 100	260,1 > 300	2640	2893	3143
100,1 > 120	260,1 > 300	2727	3037	3300
120,1 > 145	260,1 > 300	2910	3189	3466

### SUPPLEMENTI / SUPPLEMENTS

Telaio laccato con colori opachi / Matt lacquered frame	+ 10%
Telaio laccato con colori speciali / Special lacquered Frame	+ 15%
Telaio laccato opaco a campione per ordini inferiori alle 5 ante / Custom matt lacquered frame for orders lower than 5 doors	+ 15%



LUNA

# INFO TECNICHE LUNA

## DATA SHEET

Sistema di ante costituite da un telaio in estruso di alluminio giuntato con taglio a 45° e assemblato con squadrette a scomparsa e da un pannello in vetro di diverse finiture. Nella versione battente è inclusa una serratura magnetica. Le versioni a scomparsa e scorrevole sono comprese di maniglia esterna.

Door system consisting of an extruded aluminum frame jointed at 45° and assembled with concealed brackets and a glass panel in different finishes. A magnetic lock is included in the wing version. The pocket and sliding versions include an external handle.

### DIMENSIONI ANTE

### DOORS DIMENSIONS

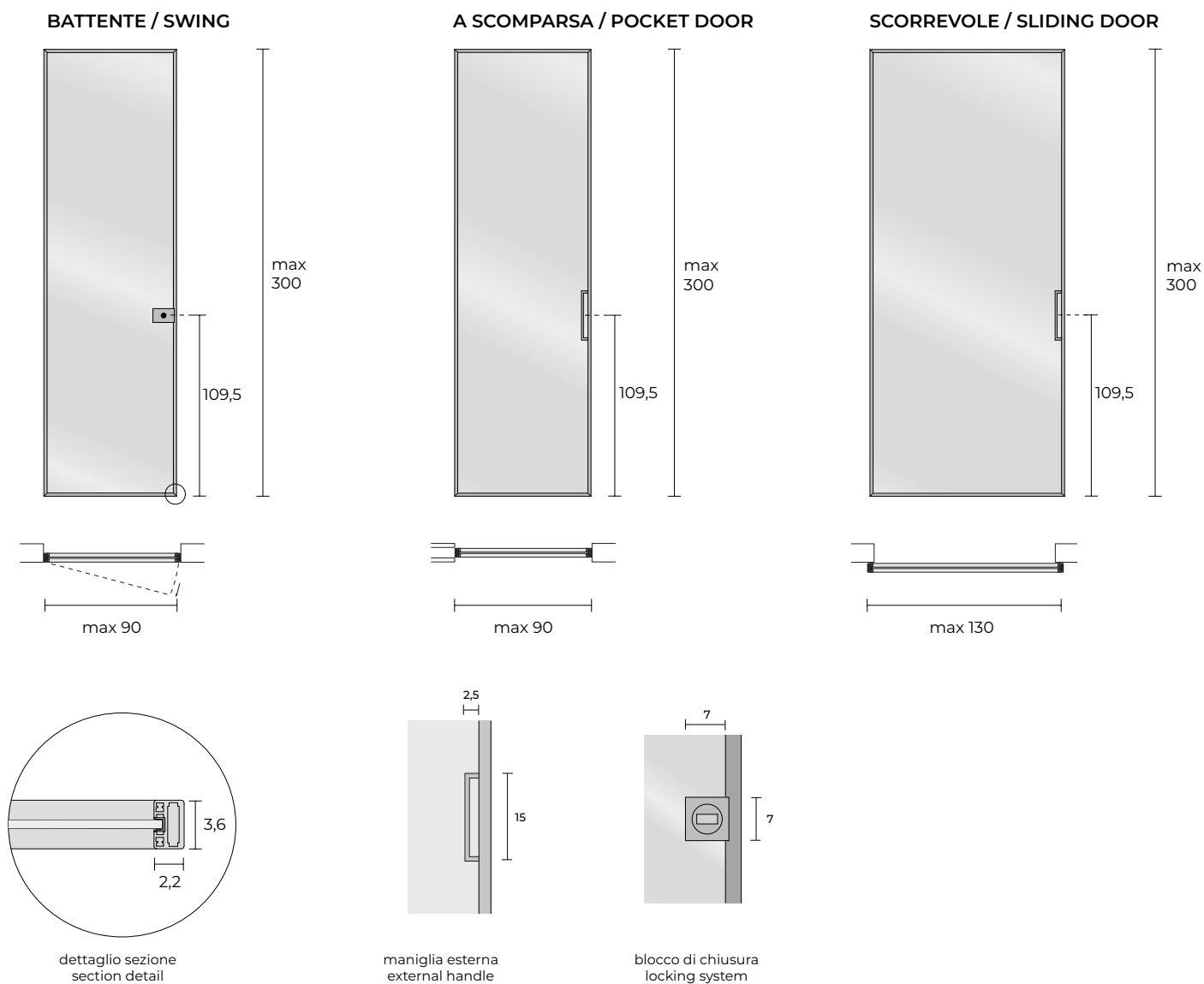

### ABBINAMENTI CON STIPITI, MECCANISMI E BINARI (da pag 103 a pag 118)

### MATCHING WITH JAMBS, MECHANISMS AND RAILS (from pag 103 to pag 118)

ANTA BATTENTE / SWING DOOR	ANTA A SCOMPARSA / POCKET DOOR	ANTA SCORREVOLE / SLIDING DOOR
Stipite Basic / Basic door jamb	Filo Muro (tipologia Essential® o Syntesis Line®)	Binari / Rails
	Stipite Basic / Basic door jamb	

**VETRI / GLASS**

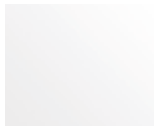

Extra



Fumo



Ambra



Acidato



Acidato Fumo



Acidato Ambra



Specchio  
Specchio Acidato



Specchio Fumo  
Specchio Fumo Acidato



Specchio Ambra  
Specchio Ambra Acidato



Stopsol



Stopsol Fumo



Stopsol Ambra

**VETRI SPECIALI / SPECIAL GLASS \***



Wire Bronzo



Wire Piombo



Cannettato



Quadrettato

**LACCATI OPACHI / MATT LACQUERED**



Neve



Corda



Fango



Tabacco

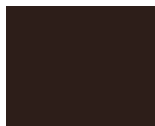

Caffè



Grigio



Antracite

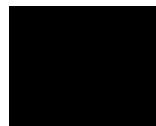

Nero

**METALLI / METALS**



Anodizzato Titanio



Anodizzato Bronzo Scuro

I colori sono indicativi / Colors are indicative

\* A richiesta / On request

# ANTE BATTENTI LUNA SWING DOORS

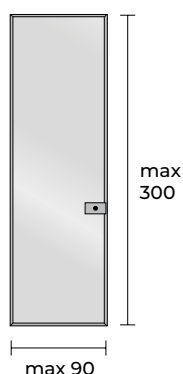

## Finiture pannello / Panel finishes

Cat. A - Extra, Fumo, Ambra

Cat. B - Acidato, Acidato Fumo, Acidato Ambra, Stopsol, Stopsol Fumo, Stopsol Ambra

Cat. C - Specchio, Specchio Fumo, Specchio Ambra, Specchio Acidato, Specchio Fumo Acidato, Specchio Ambra Acidato

## ANTA BATTENTE / SWING DOOR

cod. LUNBT

Larghezza / Width	Altezza / Height	Telaio Anodizzato Titanio o Anodizzato Bronzo Scuro / Anodizzato Titanio or Anodizzato Bronzo Scuro frame		
		Finiture pannello / Panel finishes		
		A	B	C
70	0 > 210	991	1063	1135
80	0 > 210	1025	1108	1190
90	0 > 210	1059	1152	1246
70	210,1 > 260	1070	1159	1249
80	210,1 > 260	1111	1214	1316
90	210,1 > 260	1152	1268	1384
70	260,1 > 300	1133	1236	1339
80	260,1 > 300	1180	1298	1416
90	260,1 > 300	1226	1360	1494

## SUPPLEMENTI / SUPPLEMENTS

Telaio in laccati opachi / Matt lacquered frame	+ 10%
Telaio in laccati speciali / Special lacquered frame	+ 15%
Telaio in laccati opachi a campione per ordini inferiori alle 5 ante / Custom matt lacquered frame for orders lower than 5 doors	+ 15%
Meccanismo Tira_Spingi per porte di dimensioni massime 90x250 / Tira_Spingi mechanism for doors with maximum dimensions of 90x250	400 €
Battuta per serratura / Strike for lock - cod. STIBDI	a richiesta / on request

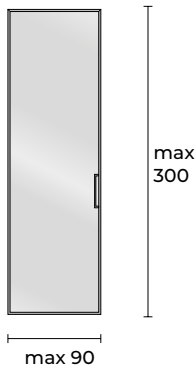

**Finiture pannello / Panel finishes**

Cat. A - Extra, Fumo, Ambra

Cat. B - Acidato, Acidato Fumo, Acidato Ambra, Stopsol, Stopsol Fumo, Stopsol Ambra

Cat. C - Specchio, Specchio Fumo, Specchio Ambra, Specchio Acidato, Specchio Fumo Acidato, Specchio Ambra Acidato

**LUNA - ANTA A SCOMPARSA / POCKET DOOR**

cod. LUNSC

Telaio Anodizzato Titanio o Anodizzato Bronzo Scuro / Anodizzato Titanio or Anodizzato Bronzo Scuro frame

Larghezza / Width	Altezza / Height	Finiture pannello / Panel finishes		
		A	B	C
75	210	<b>991</b>	<b>1063</b>	<b>1135</b>
85	210	<b>1025</b>	<b>1108</b>	<b>1190</b>
95	210	<b>1059</b>	<b>1152</b>	<b>1246</b>
75	260	<b>1070</b>	<b>1159</b>	<b>1249</b>
85	260	<b>1111</b>	<b>1214</b>	<b>1316</b>
95	260	<b>1152</b>	<b>1268</b>	<b>1384</b>

**SUPPLEMENTI / SUPPLEMENTS**

Telaio in laccati opachi / Matt lacquered frame	<b>+ 10%</b>
Telaio in laccati speciali / Special lacquered frame	<b>+ 15%</b>
Telaio in laccati opachi a campione per ordini inferiori alle 5 ante / Custom matt lacquered frame for orders lower than 5 doors	<b>+ 15%</b>

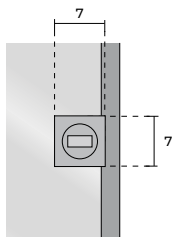

**SUPPLEMENTO BLOCCO CON SISTEMA DI CHIUSURA / SUPPLEMENT DOOR WITH LOCKING DETAIL**

cod. SUPBLV

Blocco con sistema di chiusura. La maniglia è posizionata ad un'altezza al centro di 109,5 cm / Locking detail. The handle is positioned at the middle of 109,5 cm height.

**100 €**

# ANTE SCORREVOLI LUNA SLIDING DOORS

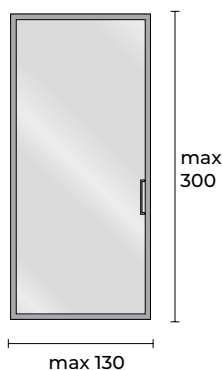

## Finiture pannello / Panel finishes

Cat. A - Extra, Fumo, Ambra

Cat. B - Acidato, Acidato Fumo, Acidato Ambra, Stopsol, Stopsol Fumo, Stopsol Ambra

Cat. C - Specchio, Specchio Fumo, Specchio Ambra, Specchio Acidato, Specchio Fumo Acidato, Specchio Ambra Acidato

## LUNA - ANTA SCORREVOLE / SLIDING DOOR

cod. LUNSC

		Telaio Anodizzato Titanio o Anodizzato Bronzo Scuro / Anodizzato Titanio or Anodizzato Bronzo Scuro frame		
Larghezza / Width	Altezza / Height	Finiture pannello / Panel finishes		
		A	B	C
70 > 100	0 > 210	<b>1090</b>	<b>1169</b>	<b>1248</b>
100,1 > 120	0 > 210	<b>1144</b>	<b>1227</b>	<b>1310</b>
120,1 > 130	0 > 210	<b>1201</b>	<b>1289</b>	<b>1375</b>
70 > 100	210,1 > 260	<b>1177</b>	<b>1274</b>	<b>1370</b>
100,1 > 120	210,1 > 260	<b>1235</b>	<b>1338</b>	<b>1442</b>
120,1 > 130	210,1 > 260	<b>1297</b>	<b>1405</b>	<b>1514</b>
70 > 100	260,1 > 300	<b>1270</b>	<b>1385</b>	<b>2497</b>
100,1 > 120	260,1 > 300	<b>1335</b>	<b>1454</b>	<b>2621</b>
120,1 > 130	260,1 > 300	<b>1400</b>	<b>1526</b>	<b>2752</b>

## SUPPLEMENTI / SUPPLEMENTS

Telaio in laccati opachi / Matt lacquered frame	<b>+ 10%</b>
Telaio in laccati speciali / Special lacquered frame	<b>+ 15%</b>
Telaio in laccati opachi a campione per ordini inferiori alle 5 ante / Custom matt lacquered frame for orders lower than 5 doors	<b>+ 15%</b>



# ANTE SCORREVOLI LUNA LAB E LUNA ART

## SLIDING DOORS

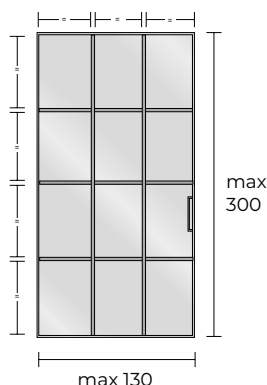

### Finiture pannello / Panel finishes

Cat. A - Extra, Fumo, Ambra

Cat. B - Acidato, Acidato Fumo, Acidato Ambra, Stopsol, Stopsol Fumo, Stopsol Ambra

### Note /Notes

Versione in cui i traversi, applicati su entrambi i lati e di dimensione 20x2mm, dividono il pannello in 3 parti uguali in larghezza e in 4 parti uguali in altezza, indipendentemente dalla misura della porta. Non è possibile avere porzioni di pannello in finiture differenti.

Version in which the 20x2mm cross bars, applied on both sides, divide the panel into 3 equal parts in width and 4 equal parts in height, regardless of the size of the door. It is not possible to have portions of the panel in different finishes.

## ANTE SCORREVOLE LUNA LAB/ LUNA LAB SLIDING DOORS

cod. LUNTSR

Larghezza / Width	Altezza / Height	Telaio Anodizzato Titanio o Anodizzato Bronzo Scuro / Anodizzato Titanio or Anodizzato Bronzo Scuro frame	
		Finiture pannello / Panel finishes	
		A	B
70 > 100	0 > 210	<b>1686</b>	<b>1894</b>
100,1 > 120	0 > 210	<b>1785</b>	<b>2035</b>
120,1 > 130	0 > 210	<b>1834</b>	<b>2107</b>
70 > 100	210,1 > 260	<b>1812</b>	<b>2060</b>
100,1 > 120	210,1 > 260	<b>1928</b>	<b>2227</b>
120,1 > 130	210,1 > 260	<b>1986</b>	<b>2311</b>
70 > 100	260,1 > 300	<b>1970</b>	<b>226</b>
100,1 > 120	260,1 > 300	<b>2107</b>	<b>2468</b>
120,1 > 130	260,1 > 300	<b>2116</b>	<b>2566</b>

## SUPPLEMENTI / SUPPLEMENTS

Telaio in laccati opachi / Matt lacquered frame	<b>+ 10%</b>
Telaio in laccati speciali / Special lacquered frame	<b>+ 15%</b>
Telaio in laccati opachi a campione per ordini inferiori alle 5 ante / Custom matt lacquered frame for orders lower than 5 doors	<b>+ 15%</b>

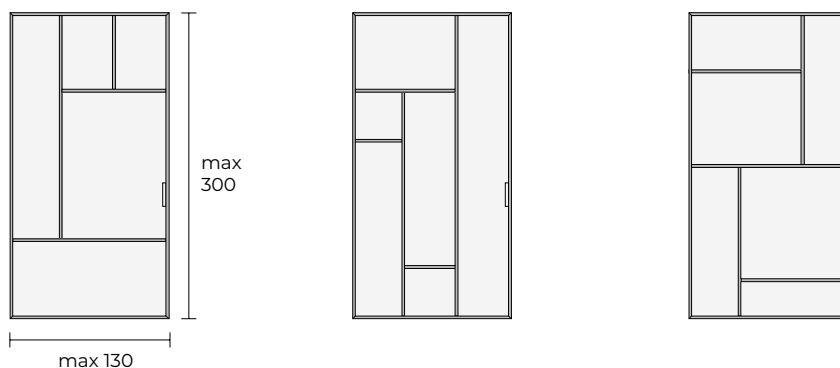

### Finiture pannello / Panel finishes

Cat. A - Extra, Fumo, Ambra

Cat. B - Acidato, Acidato Fumo, Acidato Ambra, Stopsol, Stopsol Fumo, Stopsol Ambra

### Note /Notes

Versione in cui i traversi permettono di creare decori personalizzati. Non è possibile avere porzioni di pannello in finiture differenti. Adatto solo per vetri di spessore 4 mm.

Version in which the crossbars allow you to create custom decors. It is not possible to have portions of the panel in different finishes. Suitable for 4mm thick glass only.

## ANTE SCORREVOLI LUNA ART / LUNA ART SLIDING DOORS

cod. LUNTSR

Larghezza / Width	Altezza / Height	Telaio Anodizzato Titanio o Anodizzato Bronzo Scuro / Anodizzato Titanio or Anodizzato Bronzo Scuro frame
70 > 130	0 > 300	<b>PREZZO SU RICHIESTA / PRICE ON REQUEST</b>





MISS

# INFO TECNICHE MISS DATA SHEET

Sistema di ante costituita da un pannello in tamburato di abete finger joint di diversi spessori. Nella versione battente è inclusa una serratura magnetica. Le versioni a scomparsa e scorrevole sono comprese di maniglia incassata.

System of doors made in fir-tree veneered finger joint of different thickness. A magnetic lock is included in the wing version. The pocket and sliding versions include an external handle.

## DIMENSIONI ANTE DOORS DIMENSIONS

### BATTENTE / SWING

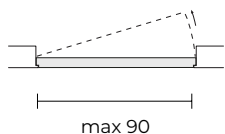
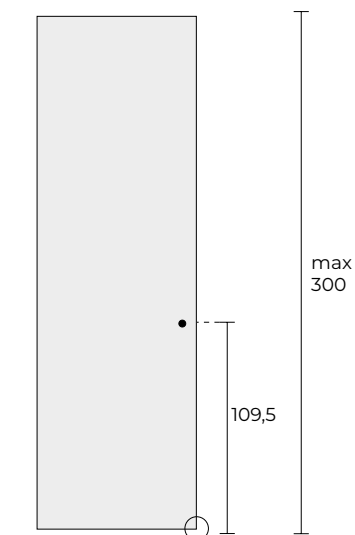

### A SCOMPARSA / POCKET DOOR

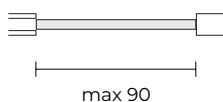
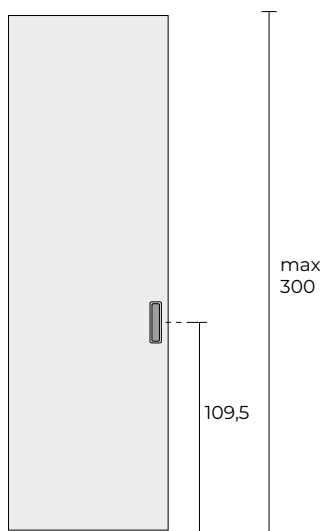

### SCORREVOLE / SLIDING DOOR

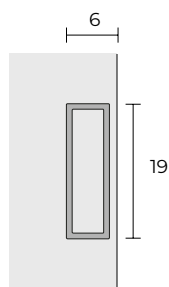
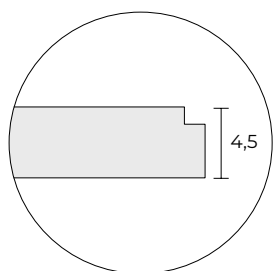
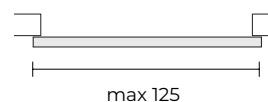
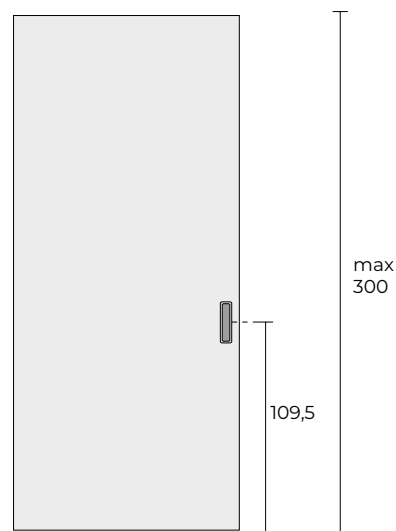

maniglia incassata  
inset handle

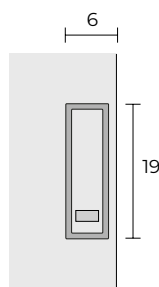

blocco di chiusura  
locking system

## ABBINAMENTI CON STIPITI, MECCANISMI E BINARI (da pag 103 a pag 118) MATCHING WITH JAMBS, MECHANISMS AND RAILS (from pag 103 to pag 118)

### ANTA BATTENTE / SWING DOOR

Stipite immurato / Built-in door jamb

Stipite Arc / Arc door jamb

Stipite Basic / Basic door jamb

### ANTA A SCOMPARSA / POCKET DOOR

Filo Muro (tipologia Essential® o Syntesis Line®)

Stipite Arc / Arc door jamb

Stipite Basic / Basic door jamb

### ANTA SCORREVOLE / SLIDING DOOR

Binari / Rails

No Rail

**LACCATI OPACHI O LUCIDI / MATT OR GLOSSY LACQUERED \***



Neve Corda Fango Tabacco



Caffè Grigio Antracite Nero

**LACCATI SPECIALI / SPECIAL LACQUERED**



Bronzo Piombo Argento



Oro Grafite Platino

**LEGNI / WOOD**



Canaletto Rovere Rovere Grigio Rovere TT

**LEGNI SPECIALI / SPECIAL WOOD \*\***

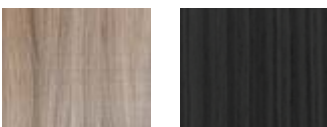

Sand Lava

I colori sono indicativi / Colors are indicative

\* Laccato Lucido a richiesta / Glossy Lacquered on request

\*\* Legni a campione previa valutazione / Special wood available upon request

# ANTE BATTENTI MISS SWING DOORS

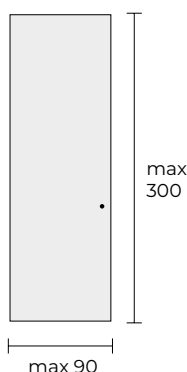

## Finiture pannello / Panel finishes

Cat. A - MDF Grezzo / Raw MDF

Cat. B - Laccati Opachi, Legni\* / Matt Lacquered, Wood\*

Cat. C - Laccati Speciali, Legni Speciali\* / Special Lacquered, Special Wood\*

\* Fornito di serie con venatura verticale / Supplied with vertical veining

ANTA BATTENTE / SWING DOOR		cod. MISFBT		
Larghezza / Width	Altezza / Height	Finiture pannello / Panel finishes		
		A	B	C
70	0 > 210	<b>539</b>	<b>936</b>	<b>1135</b>
80	0 > 210	<b>595</b>	<b>1049</b>	<b>1278</b>
90	0 > 210	<b>653</b>	<b>1163</b>	<b>1420</b>
70	210,1 > 260	<b>634</b>	<b>1125</b>	<b>1373</b>
80	210,1 > 260	<b>705</b>	<b>1266</b>	<b>1549</b>
90	210,1 > 260	<b>775</b>	<b>1408</b>	<b>1725</b>
70	260,1 > 300	<b>710</b>	<b>1277</b>	<b>1563</b>
80	260,1 > 300	<b>792</b>	<b>1440</b>	<b>1766</b>
90	260,1 > 300	<b>874</b>	<b>1602</b>	<b>1970</b>

PER ANTA DOPPIA RADDOPPIARE IL PREZZO DELL'ANTA SINGOLA / FOR DOUBLE DOOR DOUBLE UP THE PRICE OF THE DOOR

SUPPLEMENTI / SUPPLEMENTS		
Fondo da abbinare ad MDF grezzo / Primer to combine with raw MDF		<b>+ 35%</b>
Meccanismo Tira_Spingi per porte di dimensioni massime 90x270 / Tira_Spingi mechanism for doors with maximum dimensions of 90x270		<b>400 €</b>
Battuta per serratura / Strike for lock - cod. STIBDI		<b>a richiesta / on request</b>

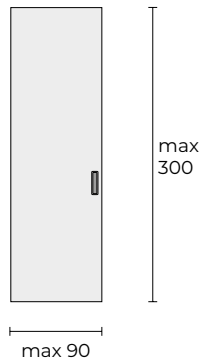

**Finiture pannello / Panel finishes**

Cat. A - MDF Grezzo / Raw MDF

Cat. B - Laccati Opachi, Legni\* / Matt Lacquered, Wood\*

Cat. C - Laccati Speciali, Legni Speciali\* / Special Lacquered, Special Wood\*

\* Fornito di serie con venatura verticale / Supplied with vertical veining

**MISS - ANTA A SCOMPARSA / POCKET DOOR**

cod. MISSC

Larghezza / Width	Altezza / Height	Finiture pannello / Panel finishes		
		A	B	C
75	210	<b>539</b>	<b>936</b>	<b>1135</b>
85	210	<b>595</b>	<b>1049</b>	<b>1278</b>
95	210	<b>653</b>	<b>1163</b>	<b>1420</b>
75	260	<b>634</b>	<b>1125</b>	<b>1373</b>
85	260	<b>705</b>	<b>1266</b>	<b>1549</b>
95	260	<b>775</b>	<b>1408</b>	<b>1725</b>

PER ANTA DOPPIA RADDOPPIARE IL PREZZO DELL'ANTA SINGOLA / FOR DOUBLE DOOR DOUBLE UP THE PRICE OF THE DOOR

**SUPPLEMENTI / SUPPLEMENTS**

Fondo da abbinare ad MDF grezzo / Primer to combine with raw MDF

**+ 35%**

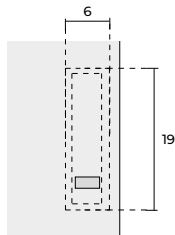

**SUPPLEMENTO BLOCCO CON SISTEMA DI CHIUSURA / SUPPLEMENT DOOR WITH LOCKING DETAIL**

Porte a scomparsa con blocco con sistema di chiusura. La maniglia è posizionata ad un'altezza al centro di 109,5 cm.  
Pocket door with locking detail. The handle is positioned at the middle of 109,5 cm height.

**100 €**

# ANTE SCORREVOLI MISS

## SLIDING DOORS

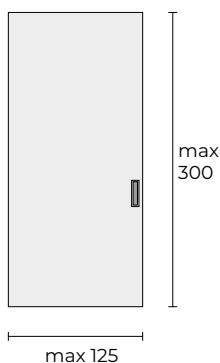

### Finiture pannello / Panel finishes

Cat. A - MDF Grezzo / Raw MDF

Cat. B - Laccati Opachi, Legni\* / Matt Lacquered, Wood\*

Cat. C - Laccati Speciali, Legni Speciali\* / Special Lacquered, Special Wood\*

\* Fornito di serie con venatura verticale / Supplied with vertical veining

### MISS - ANTA SCORREVOLE / SLIDING DOOR

cod. MISSR

Larghezza / Width	Altezza / Height	Finiture pannello / Panel finishes		
		A	B	C
70 > 100	0 > 210	<b>642</b>	<b>1038</b>	<b>1239</b>
100,1 > 120	0 > 210	<b>814</b>	<b>1238</b>	<b>1488</b>
120,1 > 125	0 > 210	<b>928</b>	<b>1437</b>	<b>1737</b>
70 > 100	210,1 > 250	<b>956</b>	<b>1487</b>	<b>1799</b>
100,1 > 120	210,1 > 250	<b>786</b>	<b>1190</b>	<b>1428</b>
120,1 > 125	210,1 > 250	<b>922</b>	<b>1428</b>	<b>1725</b>
70 > 100	250,1 > 300	<b>1058</b>	<b>1665</b>	<b>2022</b>
100,1 > 120	250,1 > 300	<b>1092</b>	<b>1724</b>	<b>2096</b>
120,1 > 125	250,1 > 300	<b>895</b>	<b>1380</b>	<b>1666</b>

PER ANTA DOPPIA RADDOPPIARE IL PREZZO DELL'ANTA SINGOLA / FOR DOUBLE DOOR DOUBLE UP THE PRICE OF THE DOOR

### SUPPLEMENTI / SUPPLEMENTS

Fondo da abbinare ad MDF grezzo / Primer to combine with raw MDF

**+ 20%**





D35

# INFO TECNICHE D35

## DATA SHEET

L'anta scorrevole D35, i cui interspazi sono 35-65-95mm e anche personalizzabili, è costituita da un telaio perimetrale in alluminio e una cornice perimetrale in legno. Può essere completato da doghe disposte verticalmente. Soluzione ideale per dividere con stile gli ambienti, lavora sugli stessi binari standard della produzione Res.

The D35 sliding door, whose gaps are 35/65-95mm and also customizable, consists of an aluminum perimeter frame and a wooden perimeter frame. It can be completed with vertically arranged slats. Ideal solution for dividing rooms with style, it works on the same standard tracks as the Res production.

### DIMENSIONI ANTE

### DOORS DIMENSIONS

#### SCORREVOLE / SLIDING DOOR

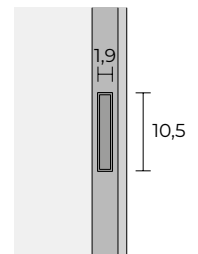
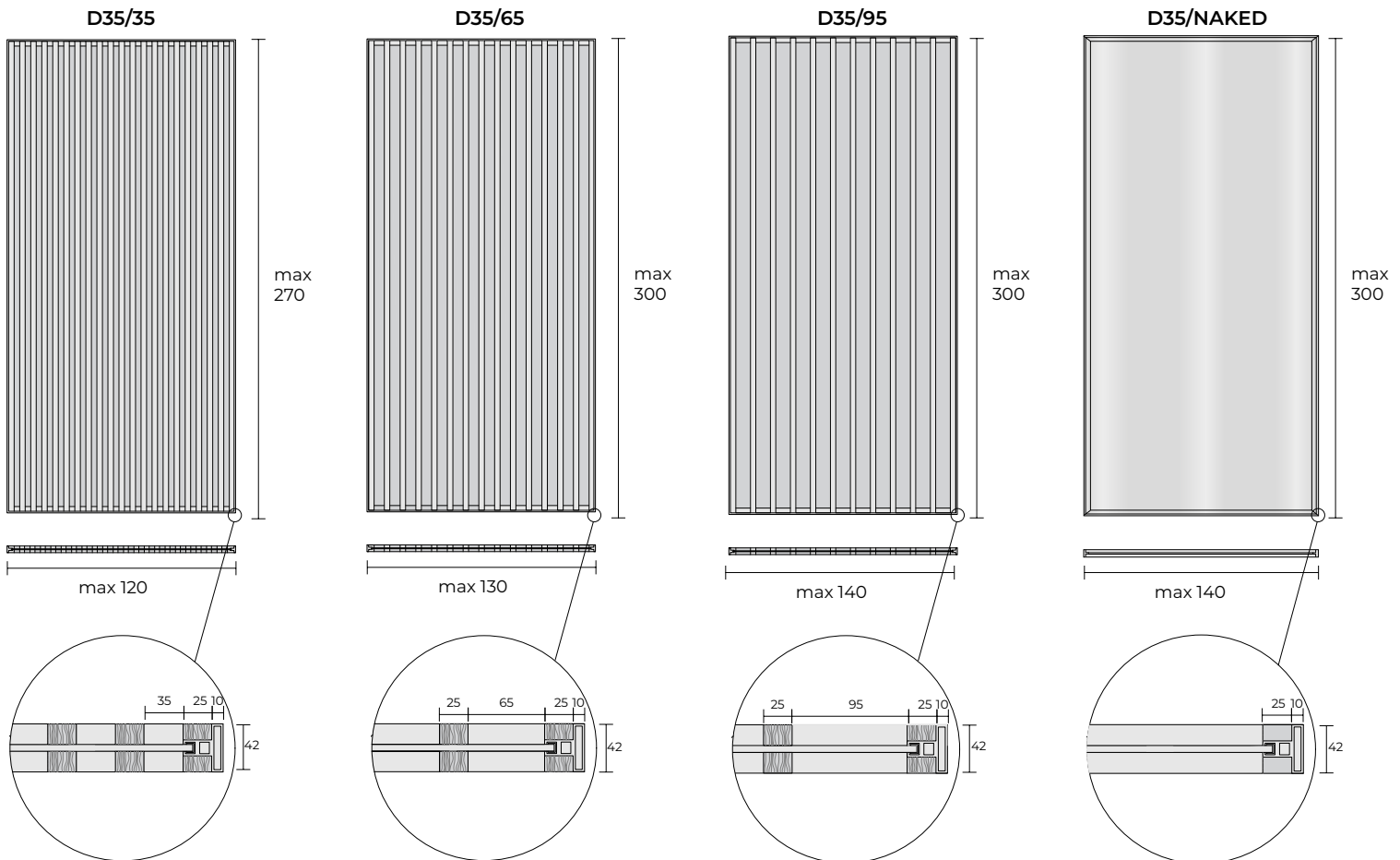

#### ABBINAMENTI CON STIPITI, MECCANISMI E BINARI (da pag 103 a pag 118)

#### MATCHING WITH JAMBS, MECHANISMS AND RAILS (from pag 103 to pag 118)

##### ANTA SCORREVOLE / SLIDING DOOR

Binari / Rails

##### FINITURE DOGHE / SLATS FINISHES

Legni / Wood

Legni Speciali / Special Wood

Laccati opachi / Matt lacquered

Laccati speciali / Special lacquered

##### FINITURE TELAIO / FRAME FINISHES

Laccati opachi / Matt lacquered

Laccati speciali / Special lacquered

Metalli / Metals

##### FINITURE PANNELLI / PANELS FINISHES

Vetri / Glasses

**VETRI / GLASS**



**LACCATI OPACHI / MATT LACQUERED**



**LACCATI SPECIALI / SPECIAL LACQUERED**



**METALLI / METALS**



**LEGNI / WOOD**



**LEGNI SPECIALI / SPECIAL WOOD \***



I colori sono indicativi / Colors are indicative

\* Legni a campione previa valutazione / Special wood available upon request

# ANTE SCORREVOLI D35/35

## SLIDING DOORS

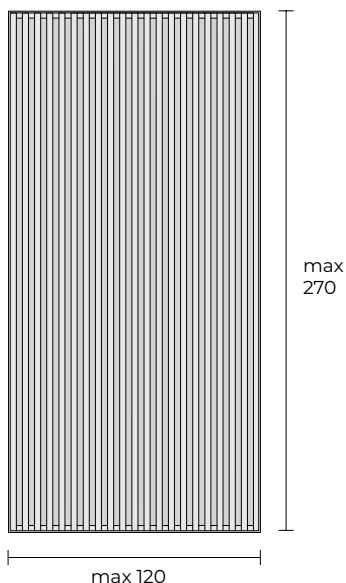

### Finiture pannello / Panel finishes

Cat. A - Extra, Fumo, Ambra

Cat. B - Acidato, Acidato Fumo, Acidato Ambra

Cat. C - Stopsol, Stopsol Fumo, Stopsol Ambra, Laccati Opachi / Matt Lacquered, Legni\* / Wood\*

Cat. D - Laccati Speciali, Legni Speciali\* / Special Lacquered, Special Wood\*

\* Fornito di serie con venatura verticale / Supplied with vertical veining

### ANTA SCORREVOLE D35 / D35 SLIDING DOOR

cod. D35SR

Telaio Anodizzato Titanio o Anodizzato Bronzo Scuro / Anodizzato Titanio or Anodizzato Bronzo Scuro frame  
DOGHE RIVESTITE IN LEGNO O LACCATO OPACO / COVERED BY WOOD OR MATT LACQUERED SLATS

Larghezza / Width	Altezza / Height	Finiture pannello / Panel finishes			
		A	B	C	D
70 > 100	0 > 210	<b>5383</b>	<b>5470</b>	<b>5498</b>	<b>5556</b>
100,1 > 120	0 > 210	<b>6397</b>	<b>6430</b>	<b>6537</b>	<b>6606</b>
70 > 100	210,1 > 240	<b>6019</b>	<b>6118</b>	<b>6151</b>	<b>6218</b>
100,1 > 120	210,1 > 240	<b>7171</b>	<b>7290</b>	<b>7330</b>	<b>7410</b>
70 > 100	240,1 > 270	<b>6655</b>	<b>6767</b>	<b>6804</b>	<b>6878</b>
100,1 > 120	240,1 > 270	<b>7944</b>	<b>8079</b>	<b>8125</b>	<b>8214</b>

Telaio Anodizzato Titanio o Anodizzato Bronzo Scuro / Anodizzato Titanio or Anodizzato Bronzo Scuro frame  
DOGHE RIVESTITE IN LEGNO SPECIALE O LACCATO SPECIALE / COVERED BY SPECIAL WOOD OR SPECIAL LACQUERED

Larghezza / Width	Altezza / Height	Finiture pannello / Panel finishes			
		A	B	C	D
70 > 100	0 > 210	<b>6460</b>	<b>6564</b>	<b>6598</b>	<b>6667</b>
100,1 > 120	0 > 210	<b>7676</b>	<b>7813</b>	<b>7844</b>	<b>7927</b>
70 > 100	210,1 > 240	<b>7223</b>	<b>7342</b>	<b>7381</b>	<b>7462</b>
100,1 > 120	210,1 > 240	<b>8605</b>	<b>8748</b>	<b>8796</b>	<b>8892</b>
70 > 100	240,1 > 270	<b>7986</b>	<b>8120</b>	<b>8165</b>	<b>8255</b>
100,1 > 120	240,1 > 270	<b>9533</b>	<b>9695</b>	<b>9750</b>	<b>9857</b>

### SUPPLEMENTI / SUPPLEMENTS

Telaio in laccati opachi / Matt lacquered frame

+ 10%

Telaio in laccati speciali / Special lacquered frame

+ 15%

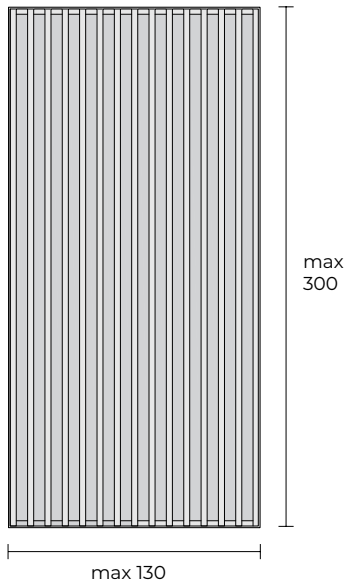

**Finiture pannello / Panel finishes**

Cat. A - Extra, Fumo, Ambra

Cat. B - Acidato, Acidato Fumo, Acidato Ambra

Cat. C - Stopsol, Stopsol Fumo, Stopsol Ambra, Laccati Opachi / Matt Lacquered, Legni\* / Wood\*

Cat. D - Laccati Speciali, Legni Speciali\* / Special Lacquered, Special Wood\*

\* Fornito di serie con venatura verticale / Supplied with vertical veining

**ANTA SCORREVOLE D35/65 / D35/65 SLIDING DOOR**

cod. D35SR

Telaio Anodizzato Titanio o Anodizzato Bronzo Scuro / Anodizzato Titanio or Anodizzato Bronzo Scuro frame  
DOGHE RIVESTITE IN LEGNO O LACCATO OPACO / COVERED BY WOOD OR MATT LACQUERED SLATS

Larghezza / Width	Altezza / Height	Finiture pannello / Panel finishes			
		A	B	C	D
70 > 100	0 > 210	<b>4014</b>	<b>4100</b>	<b>4129</b>	<b>4187</b>
100,1 > 130	0 > 210	<b>4800</b>	<b>4905</b>	<b>4939</b>	<b>5009</b>
70 > 100	210,1 > 260	<b>4454</b>	<b>4553</b>	<b>4587</b>	<b>4653</b>
100,1 > 130	210,1 > 260	<b>5345</b>	<b>5465</b>	<b>5505</b>	<b>5571</b>
70 > 100	260,1 > 300	<b>4895</b>	<b>5006</b>	<b>5044</b>	<b>5118</b>
100,1 > 130	260,1 > 300	<b>5890</b>	<b>6025</b>	<b>6070</b>	<b>6160</b>

Telaio Anodizzato Titanio o Anodizzato Bronzo Scuro / Anodizzato Titanio or Anodizzato Bronzo Scuro frame  
DOGHE RIVESTITE IN LEGNO SPECIALE O LACCATO SPECIALE / COVERED BY SPECIAL WOOD OR SPECIAL LACQUERED

Larghezza / Width	Altezza / Height	Finiture pannello / Panel finishes			
		A	B	C	D
70 > 100	0 > 210	<b>4819</b>	<b>4920</b>	<b>4955</b>	<b>5025</b>
100,1 > 130	0 > 210	<b>5760</b>	<b>5886</b>	<b>5927</b>	<b>6011</b>
70 > 100	210,1 > 260	<b>5345</b>	<b>5464</b>	<b>5505</b>	<b>5584</b>
100,1 > 130	210,1 > 260	<b>6414</b>	<b>6558</b>	<b>6606</b>	<b>6685</b>
70 > 100	260,1 > 300	<b>5874</b>	<b>6007</b>	<b>6053</b>	<b>6142</b>
100,1 > 130	260,1 > 300	<b>7068</b>	<b>7230</b>	<b>7284</b>	<b>7393</b>

**SUPPLEMENTI / SUPPLEMENTS**

Telaio in laccati opachi / Matt lacquered frame

**+ 10%**

Telaio in laccati speciali / Special lacquered frame

**+ 15%**

# ANTE SCORREVOLI D35/95

## SLIDING DOORS

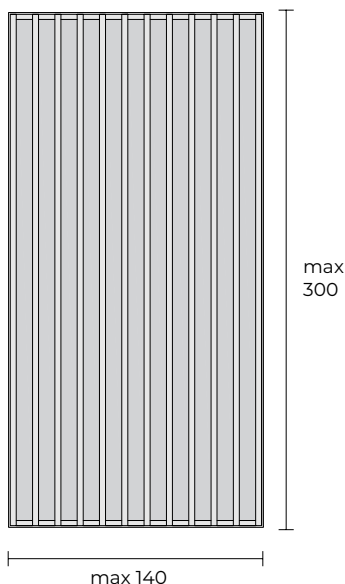

### Finiture pannello / Panel finishes

Cat. A - Extra, Fumo, Ambra

Cat. B - Acidato, Acidato Fumo, Acidato Ambra

Cat. C - Stopsol, Stopsol Fumo, Stopsol Ambra, Laccati Opachi / Matt Lacquered, Legni\* / Wood\*

Cat. D - Laccati Speciali, Legni Speciali\* / Special Lacquered, Special Wood\*

\* Fornito di serie con venatura verticale / Supplied with vertical veining

### ANTA SCORREVOLE D35/95 / D35/95 SLIDING DOOR

cod. D35SR

		Telaio Anodizzato Titanio o Anodizzato Bronzo Scuro / Anodizzato Titanio or Anodizzato Bronzo Scuro frame DOGHE RIVESTITE IN LEGNO O LACCATO OPACO / COVERED BY WOOD OR MATT LACQUERED SLATS			
Larghezza / Width	Altezza / Height	Finiture pannello / Panel finishes			
		A	B	C	D
70 > 100	0 > 210	3786	3872	3901	3959
100,1 > 120	0 > 210	4343	4448	4483	4553
120,1 > 140	0 > 210	5067	5190	5231	5312
70 > 100	210,1 > 260	4194	4293	4326	4392
100,1 > 120	210,1 > 260	4824	4943	4983	5063
120,1 > 140	210,1 > 260	5628	5767	5814	5907
70 > 100	260,1 > 300	4601	4713	4750	4825
100,1 > 120	260,1 > 300	5303	5438	5483	5573
120,1 > 140	260,1 > 300	6187	6344	6397	6502

		Telaio Anodizzato Titanio o Anodizzato Bronzo Scuro / Anodizzato Titanio or Anodizzato Bronzo Scuro frame DOGHE RIVESTITE IN LEGNO SPECIALE O LACCATO SPECIALE / COVERED BY SPECIAL WOOD OR SPECIAL LACQUERED			
Larghezza / Width	Altezza / Height	Finiture pannello / Panel finishes			
		A	B	C	D
70 > 100	0 > 210	4543	4646	4681	4751
100,1 > 120	0 > 210	5212	5338	5380	5464
120,1 > 140	0 > 210	6081	6228	6277	6375
70 > 100	210,1 > 260	5033	5152	5191	5270
100,1 > 120	210,1 > 260	5789	5932	5980	6076
120,1 > 140	210,1 > 260	6755	6921	6977	7089
70 > 100	260,1 > 300	5521	5656	5700	5790
100,1 > 120	260,1 > 300	6364	6526	6580	6688
120,1 > 140	260,1 > 300	7425	7614	7677	7803

### SUPPLEMENTI / SUPPLEMENTS

Telaio in laccati opachi / Matt lacquered frame

+ 10%

Telaio in laccati speciali / Special lacquered frame

+ 15%

# ANTE SCORREVOLI D35 NAKED E D35 FREE

## SLIDING DOORS

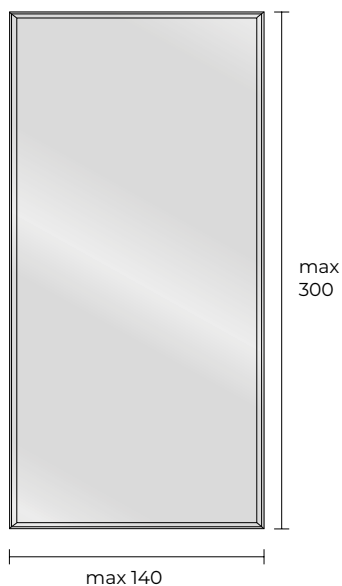

### Finiture telaio / Frame finishes

Anodizzato Titanio, Anodizzato Bronzo Scuro

### Finiture pannello / Panel finishes

Cat. A - Extra, Fumo, Ambra

Cat. B - Acidato, Acidato Fumo, Acidato Ambra

Cat. C - Stopsol, Stopsol Fumo, Stopsol Ambra, Laccati Opachi / Matt Lacquered, Legni\* / Wood\*

Cat. D - Laccati Speciali, Legni Speciali\* / Special Lacquered, Special Wood\*

\* Fornito di serie con venatura verticale / Supplied with vertical veining

### ANTA SCORREVOLE D35 NAKED / D35 NAKED SLIDING DOOR

cod. D35NSR

Larghezza / Width

Altezza / Height

70 > 140

0 > 300

PREZZO SU RICHIESTA / PRICE ON REQUEST

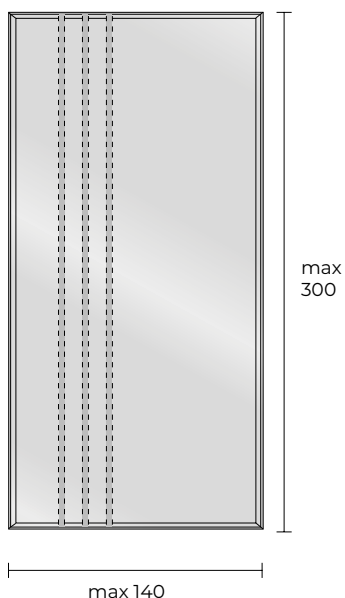

### Finiture telaio / Frame finishes

Anodizzato Titanio, Anodizzato Bronzo Scuro

### Finiture pannello / Panel finishes

Cat. A - Extra, Fumo, Ambra

Cat. B - Acidato, Acidato Fumo, Acidato Ambra

Cat. C - Stopsol, Stopsol Fumo, Stopsol Ambra, Laccati Opachi / Matt Lacquered, Legni\* / Wood\*

Cat. D - Laccati Speciali, Legni Speciali\* / Special Lacquered, Special Wood\*

### Note /Notes

Versione personalizzabile dal cliente sia per la quantità di doghe verticali che per la posizione e la distanza tra esse.

Version customizable by the customer both for the quantity of vertical slats and for the position and the distance between them.

\* Fornito di serie con venatura verticale / Supplied with vertical veining

### ANTA SCORREVOLE D35 FREE / D35 FREE SLIDING DOOR

cod. D35SR

Larghezza / Width

Altezza / Height

70 > 140

0 > 300

PREZZO SU RICHIESTA / PRICE ON REQUEST







# INFO TECNICHE FAN

## DATA SHEETS

Questa anta basculante prevede tre versioni: **Fan**, **Fan Frame** e **Fan Mono**.

La versione **Fan** è composta da un pannello in tamburato di abete finger joint con profili verticali in alluminio per pannelli laccati o in vetro laccato. La versione **Fan Frame** invece è costituita da una struttura in legno con profili verticali in alluminio per pannelli in vetro trasparente provvisti di cornice perimetrale retrolaccata nera. La versione **Fan Mono** infine prevede un telaio in legno e un singolo pannello in vetro in posizione centrale. Maniglia a vaschetta inclusa per tutte le versioni.

Con l'utilizzo di Fan si può finalmente dire addio ai limiti imposti dalle normali porte battenti. Grazie all'esclusivo sistema pivot, studiato per essere installato su porte fino a 250 kg, si possono chiudere ambienti utilizzando una sola anta, anche di grandi dimensioni. Il sistema è progettato per restituire un'apertura e una chiusura morbida e bilanciata, in base al peso e alla dimensione della porta, e comunque regolabile a proprio gusto. Inoltre tutto il sistema è integrato nell'anta, così che a pavimento e a soffitto andranno installate solo delle piastre in acciaio, senza dover realizzare opere invasive o preventive.

This pivot door has three versions: Fan, Fan Frame and Fan Mono.

The **Fan** version is made up of finger joint fir honeycomb panel with vertical aluminum profile for lacquered panels or lacquered glass panels. The **Fan Frame** version, on the other hand, consists of a wooden structure with vertical aluminum profiles for transparent glass panels provided of black back-lacquered perimeter frame. Finally, the **Fan Mono** version includes a wooden frame and a single glass panel in the middle position. Inset handle included for all versions. Thanks to Fan model you can finally say goodbye to the limits imposed by the normal swing doors. Thanks to the exclusive Pivot system, designed to be installed on doors up to 250 kg, you can close rooms using only one door, of enormous size, too. The system is designed to provide an opening and closing softly balanced, based on the weight and size of the door, and anyway adjustable to your taste. Moreover, all the system is integrated into the door, so that both on the floor and on the ceiling must be installed only steel plates, without having to make invasive or preventive works; the product is therefore compatible with the existing building situations without the need for reinforcements.

### DIMENSIONI ANTE DOORS DIMENSIONS

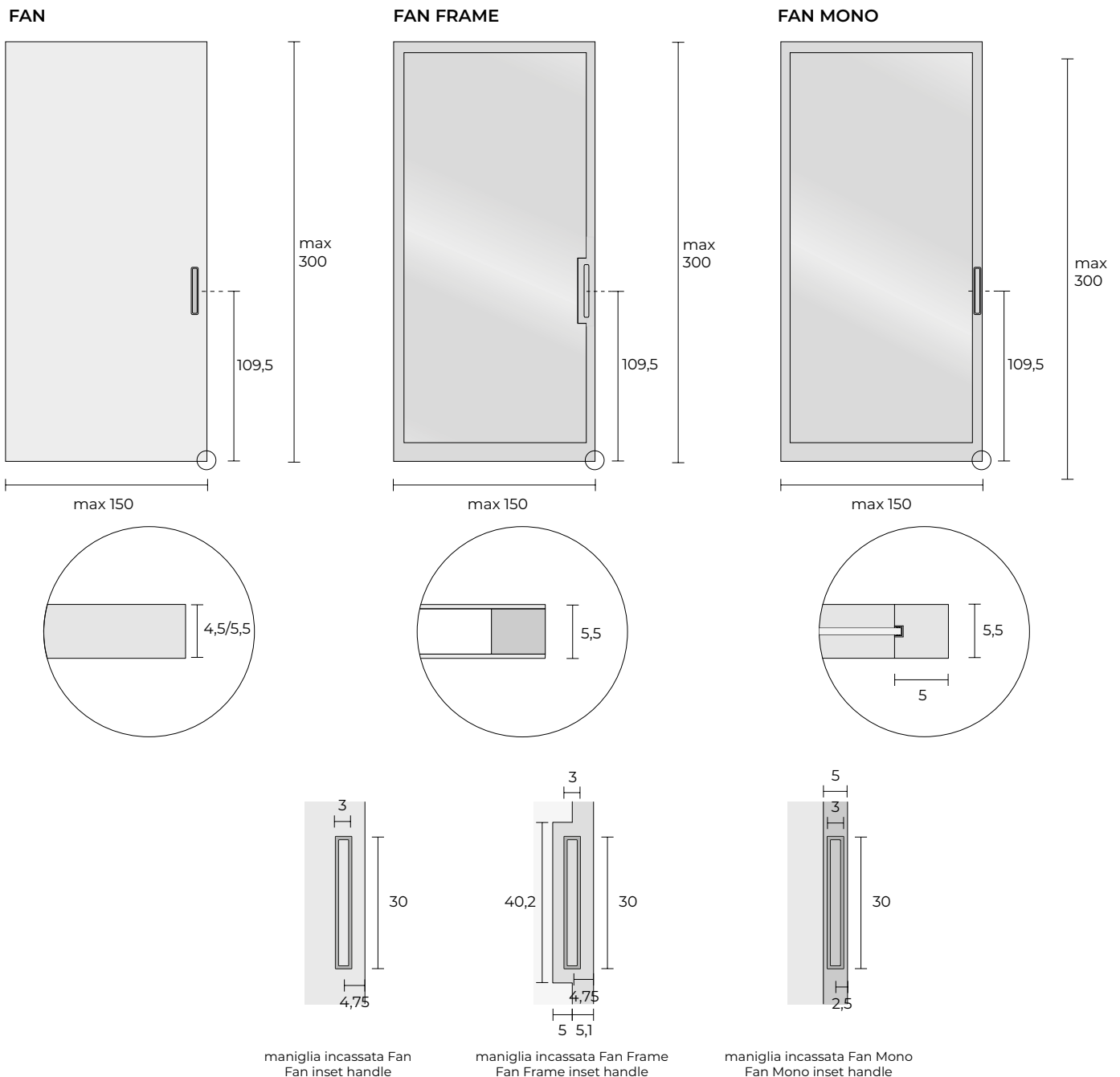

**VETRI / GLASS**



**VETRI LACCATI / LACQUERED GLASS**



**VETRI LACCATI SPECIALI / SPECIAL LACQUERED GLASS**

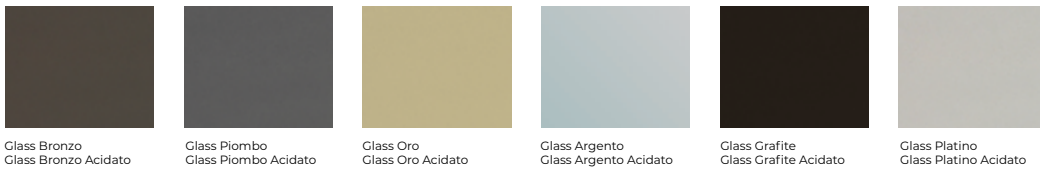

**LACCATI OPACHI / MATT LACQUERED**

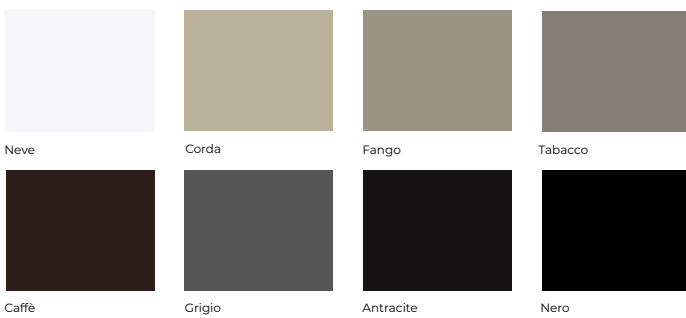

**LACCATI SPECIALI / SPECIAL LACQUERED**

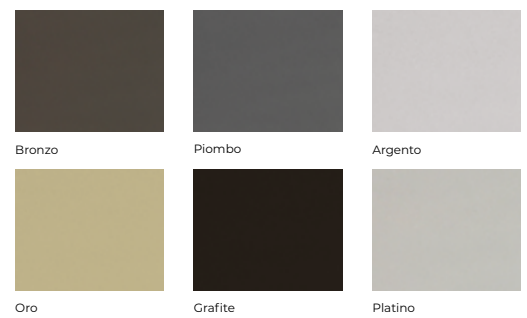

**LEGNI / WOOD**



**LEGNI SPECIALI / SPECIAL WOOD \*\***

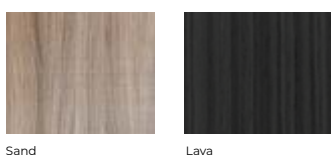

**GRES PORCELLANATO / PORCELAIN STONEWARE \***

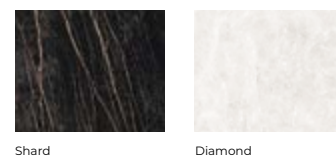

I colori sono indicativi / Colors are indicative

\* A richiesta / On request

\*\* Legni a campione previa valutazione / Special wood available upon request

## PORTE PIVOT FAN PIVOT DOORS

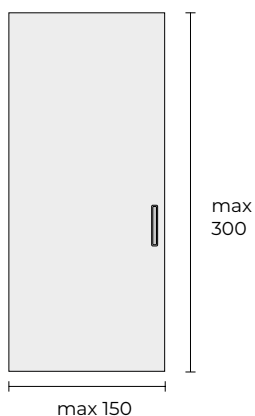

### Finiture pannello / Panel finishes

Cat. A - Laccati Opachi, Legni\* / Matt Lacquered, Wood\*

Cat. B - Laccati Speciali, Legni Speciali\* / Special Lacquered, Special Wood\*

\* Fornito di serie con venatura verticale / Supplied with vertical veining

FAN - PORTA PIVOT / PIVOT DOOR		cod. FANBI	
Larghezza / Width	Altezza / Height	Finiture / Finishes	
		A	B
90 > 120	0 > 220	<b>2823</b>	<b>3388</b>
90 > 120	220,1 > 250	<b>3633</b>	<b>4360</b>
90 > 120	250,1 > 300	<b>4321</b>	<b>5185</b>
120,1 > 150	0 > 220	<b>3977</b>	<b>4745</b>
120,1 > 150	220,1 > 250	<b>4493</b>	<b>5392</b>
120,1 > 150	250,1 > 300	<b>5353</b>	<b>6424</b>

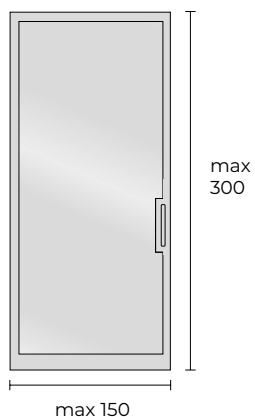

### Finiture pannello / Panel finishes

Cat. A - Extra, Fumo, Ambra

Cat. B - Acidato, Acidato Fumo, Acidato Ambra

Cat. C - Stopsol, Stopsol Fumo, Stopsol Ambra

### Note /Notes

Vetro con cornice perimetrale retrolaccata Nero e profilo in alluminio laccato color Nero.

Glass panel with Nero back-lacquered perimeter frame and Nero lacquered aluminium frame.

FAN FRAME - PORTA PIVOT / PIVOT DOOR		cod. FANFBI		
Larghezza / Width	Altezza / Height	Finiture / Finishes		
		A	B	C
90 > 120	0 > 220	<b>2662</b>	<b>2962</b>	<b>3187</b>
90 > 120	220,1 > 250	<b>2903</b>	<b>3202</b>	<b>3500</b>
90 > 120	250,1 > 300	<b>3305</b>	<b>3663</b>	<b>4021</b>
120,1 > 150	0 > 220	<b>3091</b>	<b>3419</b>	<b>3748</b>
120,1 > 150	220,1 > 250	<b>3391</b>	<b>3763</b>	<b>4136</b>
120,1 > 150	250,1 > 300	<b>3890</b>	<b>4334</b>	<b>4785</b>

### SUPPLEMENTI / SUPPLEMENTS

Telaio in laccati opachi / Matt lacquered frame	<b>+ 10%</b>
Telaio in laccati speciali / Special lacquered frame	<b>+ 15%</b>

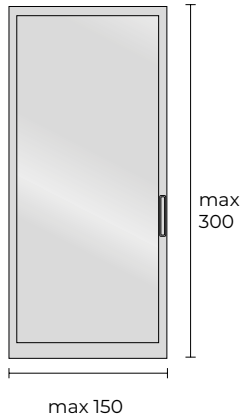

**Finiture pannello / Panel finishes**

Cat. A - Extra, Fumo, Ambra

Cat. B - Acidato, Acidato Fumo, Acidato Ambra

Cat. C - Stopsol, Stopsol Fumo, Stopsol Ambra

**FAN MONO - PORTA PIVOT / PIVOT DOOR**

cod. FANMBI

Larghezza / Width	Altezza / Height	Telaio laccato opaco / Matt lacquered frame		
		A	B	C
90 > 120	0 > 220	<b>2095</b>	<b>2225</b>	<b>2356</b>
90 > 120	220,1 > 250	<b>2288</b>	<b>2437</b>	<b>2586</b>
90 > 120	250,1 > 300	<b>2612</b>	<b>2791</b>	<b>2970</b>
120,1 > 150	0 > 220	<b>2436</b>	<b>2600</b>	<b>2765</b>
120,1 > 150	220,1 > 250	<b>2677</b>	<b>2864</b>	<b>3050</b>
120,1 > 150	250,1 > 300	<b>3079</b>	<b>3302</b>	<b>3526</b>

**SUPPLEMENTI / SUPPLEMENTS**

Telaio laccato con colori speciali / Special lacquered frame

+ X%

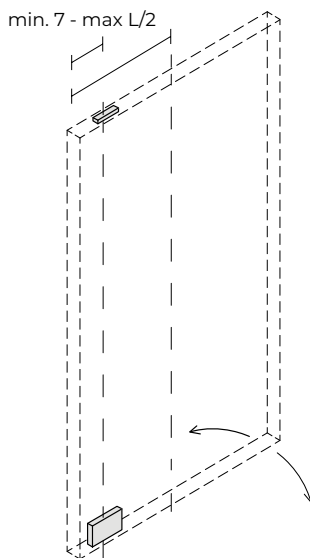

**ELEMENTI / ELEMENTS**

cod. SISTPI

**Descrizione / Description**

Cerniera per sistema a bilico per porte fino a 500 kg / Hinge for pivot system for doors up to 500 kg

**1400 €\***

\*costi già al netto di sconto / already discounted costs

**SUPPLEMENTI / SUPPLEMENTS**

Battuta per apertura monodirezionale / Stop for one-way opening - cod. STIBDI

**400 €**





# PORTA BATTENTE 10.8

## SWING DOOR

E' una porta complanare in tamburato da 10 a 13 cm di spessore, adattabile in base alla dimensione del muro. E' composta da stipiti verticali in legno lamellare ed è priva di voltino, quindi rimane a filo soffitto. Nonostante il suo forte spessore 10.8 risulta leggera. Completano la dotazione le cerniere regolabili, che permettono un'apertura a 180° e la serratura a magnete. La porta viene fornita con stipite da montare sul posto.

It is a coplanar door from 10 to 13 cm thick honeycomb, adaptable according to the size of the wall. It is made up of vertical lamellar wood jambs and has no vault, so it remains flush with the ceiling. Despite its strong thickness, 10.8 is light. The equipment is completed by the adjustable hinges, which allow a 180° opening and the magnet lock. The door is supplied with jamb to be mounted on site.

### DIMENSIONI ANTE

### DOORS DIMENSIONS

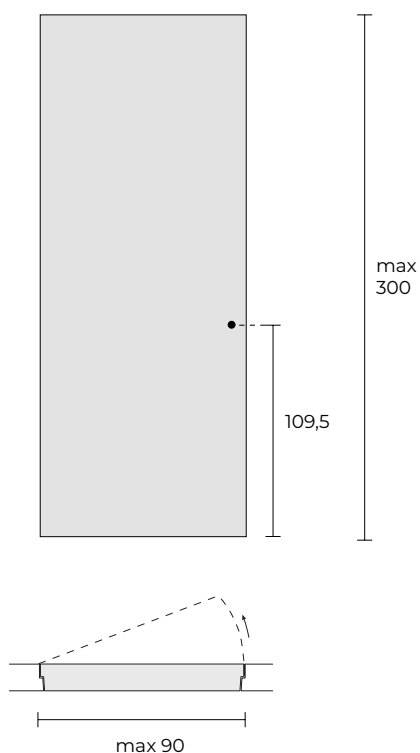

#### LACCATI OPACHI / MATT LACQUERED



Neve

Corda

Fango

Tabacco



Caffè



Grigio



Antracite



Nero

#### LACCATI SPECIALI / SPECIAL LACQUERED



Bronzo

Piombo

Argento



Oro



Grafite

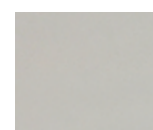

Platino

I colori sono indicativi / Colors are indicative



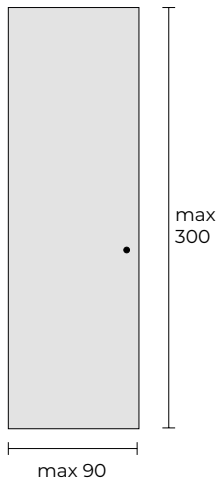

**Finiture pannello / Panel finishes**  
 Cat. A - MDF grezzo / Raw MDF  
 Cat. B - Laccati Opachi / Matt Lacquered  
 Cat. C - Laccati Speciali / Special Lacquered

ANTA BATTENTE / SWING DOOR

cod. BT108

Larghezza / Width	Altezza / Height	Finiture pannello / Panel finishes		
		A	B	C
70	0 > 210	1389	2530	3130
80	0 > 210	1511	2872	3557
90	0 > 210	1682	3214	3984
70	210,1 > 260	1625	3100	3841
80	210,1 > 260	1837	3523	4371
90	210,1 > 260	2050	3945	4900
70	260,1 > 300	1854	3555	4411
80	260,1 > 300	2099	4043	5022
90	260,1 > 300	2344	4531	5632

SUPPLEMENTI / SUPPLEMENTS

Fondo da aggiungere a porta grezza / Base finish to be added to the raw door

+ 300 €

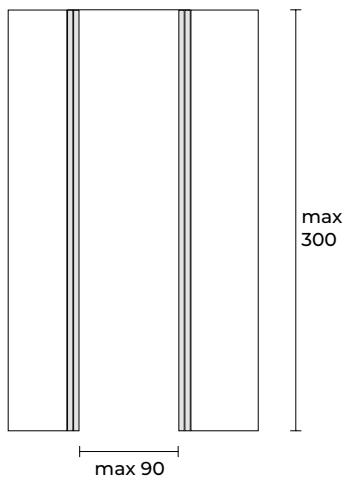

STIPITE GREZZO / DOOR JAMB UNFINISHED

cod. BTS108

Larghezza / Width	Altezza / Height	Tipologia / Type	Grezzo / Unfinished
70 - 80 - 90	0 > 210	Stipite per pareti in cartongesso / Door jamb for plaster doors	250
70 - 80 - 90	0 > 210	Stipite e pre-stipite per pareti in muratura / Door jamb and pre-door jamb for brick wall	475
70 - 80 - 90	210,1 > 260	Stipite per pareti in cartongesso / Door jamb for plaster doors	310
70 - 80 - 90	210,1 > 260	Stipite e pre-stipite per pareti in muratura / Door jamb and pre-door jamb for brick wall	590
70 - 80 - 90	260,1 > 300	Stipite per pareti in cartongesso / Door jamb for plaster doors	360
70 - 80 - 90	260,1 > 300	Stipite e pre-stipite per pareti in muratura / Door jamb and pre-door jamb for brick wall	680





CLICK

Ante realizzate in tamburato di abete con spessore 2,5 cm. Fissate lateralmente tramite cerniere ad attacco automatico e montate sul telaio di dimensioni 10,5x2,5 cm. Il telaio forma un'architrave che viene bloccata a muro. Attenzione: non consente nessun tipo di regolazione. A completamento sono previste fasce di compensazione e coprifilo laterali e superiori. Maniglia di serie incassata. Nella versione a libro è completata da binario di scorrimento in estruso di alluminio.

Doors made of hollow-core fir with a thickness of 2.5 cm. Secured laterally by means of automatic hinges and mounted on the frame with dimensions 10.5x2.5 cm. The frame forms an architrave that is blocked to the wall. Warning: it does not allow any type of adjustment. To complete, compensation bands and side and top cover strips are provided. Standard built-in handle. In the folding and sliding version it is completed by a sliding track in extruded aluminum.

**DIMENSIONI ANTE**  
**DOORS DIMENSIONS**

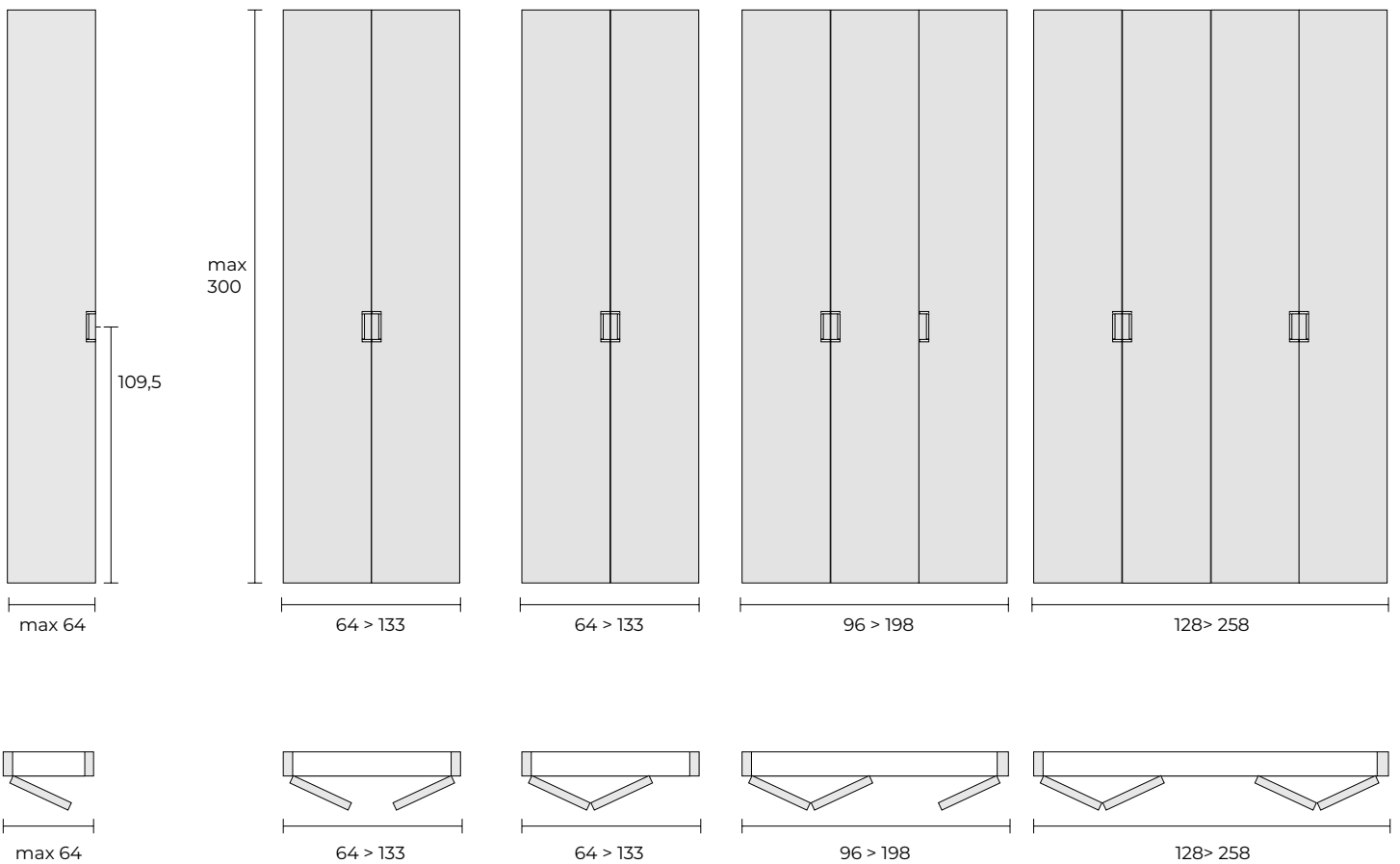

**LACCATI OPACHI O LUCIDI / MATT OR GLOSSY LACQUERED \***



Neve Corda Fango Tabacco



Caffè Grigio Antracite Nero

**LACCATI SPECIALI / SPECIAL LACQUERED**



Bronzo Piombo Argento



Oro Grafite Platino

**LEGNI / WOOD**



Canaletto Rovere Rovere Grigio Rovere TT

**LEGNI SPECIALI / SPECIAL WOOD \*\***

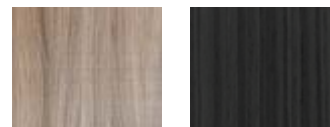

Sand Lava

I colori sono indicativi / Colors are indicative

\* Laccato Lucido a richiesta / Glossy Lacquered on request

\*\* Legni a campione previa valutazione / Special wood available upon request

# ANTE CLICK DOOR

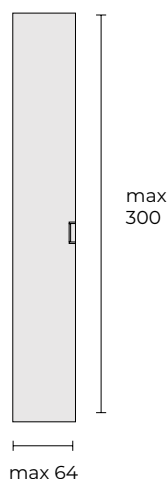

## Finiture pannello / Panel finishes

Cat. A - MDF grezzo / Raw MDF

Cat. B - Laccati Opachi / Matt Lacquered, Legni\* / Wood\*

Cat. C - Laccati Speciali, Legni Speciali\* / Special Lacquered, Special Wood\*

\* Fornito di serie con venatura verticale / Supplied with vertical veining

## ANTE BATTENTI O A LIBRO / HINGED OR FOLDING DOORS cod. CLICKBT

Larghezza Width	Altezza Height	Finiture / Finishes		
		A	B	C
0 > 32	0 > 240	<b>195</b>	<b>244</b>	<b>292</b>
	240,1 > 270	<b>229</b>	<b>287</b>	<b>344</b>
	270,1 > 300	<b>253</b>	<b>317</b>	<b>380</b>
32,1 > 45	0 > 240	<b>275</b>	<b>344</b>	<b>413</b>
	240,1 > 270	<b>322</b>	<b>403</b>	<b>484</b>
	270,1 > 300	<b>356</b>	<b>445</b>	<b>534</b>
45,1 > 52	0 > 240	<b>317</b>	<b>396</b>	<b>475</b>
	240,1 > 270	<b>373</b>	<b>466</b>	<b>559</b>
	270,1 > 300	<b>412</b>	<b>515</b>	<b>616</b>
52,1 > 64	0 > 240	<b>389</b>	<b>487</b>	<b>584</b>
	240,1 > 270	<b>458</b>	<b>573</b>	<b>687</b>
	270,1 > 300	<b>505</b>	<b>633</b>	<b>759</b>

## PORTALI COMPLETI DI MECCANISMI DI APERTURA / PORTALS COMPLETE WITH OPENING MECHANISMS cod. CLICKPO

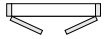
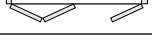
Larghezza e tipologia Width and typology	Altezza Height	Finiture / Finishes		
		A	B	C
 0 > 68 per 1 anta battente for 1 swing doors	0 > 240	<b>778</b>	<b>973</b>	<b>1168</b>
	240,1 > 270	<b>915</b>	<b>1145</b>	<b>1374</b>
	270,1 > 300	<b>1010</b>	<b>1265</b>	<b>1518</b>
 64 > 133 per 2 ante battenti for 2 swing doors	0 > 240	<b>1311</b>	<b>1639</b>	<b>1967</b>
	240,1 > 270	<b>1536</b>	<b>1920</b>	<b>2153</b>
	270,1 > 300	<b>1686</b>	<b>2108</b>	<b>2365</b>
 64 > 133 per 2 ante a libro for 2 folding doors	0 > 240	<b>1311</b>	<b>1639</b>	<b>2635</b>
	240,1 > 270	<b>1699</b>	<b>2124</b>	<b>2655</b>
	270,1 > 300	<b>1686</b>	<b>2108</b>	<b>2530</b>
 96 > 198 per 2 ante a libro e 1 battente for 2 folding door and 1 swing door	0 > 240	<b>1847</b>	<b>2309</b>	<b>2771</b>
	240,1 > 270	<b>2155</b>	<b>2694</b>	<b>3233</b>
	270,1 > 300	<b>2363</b>	<b>2954</b>	<b>3545</b>
 128 > 258 per 4 ante a libro for 4 folding doors	0 > 240	<b>2381</b>	<b>2977</b>	<b>3573</b>
	240,1 > 270	<b>2775</b>	<b>3469</b>	<b>4163</b>
	270,1 > 300	<b>3041</b>	<b>3802</b>	<b>4562</b>

## SUPPLEMENTI / SUPPLEMENTS

Laccato opaco a campione da aggiungere al prezzo della versione laccato opaco, per ordini inferiori alle 5 ante  
 Custom matt lacquered to be added to the price of the matt lacquered version, for orders lower than 5 doors

**+ 10%**

**COPRISTIPITE VERTICALI L. 7 SP. 1 / VERTICAL COVER-JAMB W. 7 TH. 1 CM**

Altezza / Height	Finiture / Finishes		
	A	B	C
0 > 240	<b>80</b>	<b>100</b>	<b>120</b>
240,1 > 270	<b>90</b>	<b>113</b>	<b>136</b>
270,1 > 300	<b>100</b>	<b>125</b>	<b>150</b>

**COPRISTIPITE ORIZZONTALI L. 7 SP. 1 / HORIZONTAL COVER-JAMB W. 7 TH. 1 CM**

Altezza / Height	Finiture / Finishes		
	A	B	C
0 > 240	<b>80</b>	<b>100</b>	<b>120</b>
240,1 > 300	<b>100</b>	<b>125</b>	<b>150</b>

**FASCE DI COMPENSAZIONE VERTICALI L. DA 1 A 10 SP. 2,5 CM / VERTICAL FILLING LATH FROM 1 TO 10 W. 7 TH. 2,5 CM**

Altezza / Height	Finiture / Finishes		
	A	B	C
0 > 240	<b>115</b>	<b>144</b>	<b>173</b>
240,1 > 270	<b>129</b>	<b>161</b>	<b>194</b>
270,1 > 300	<b>143</b>	<b>179</b>	<b>215</b>

**FASCE DI COMPENSAZIONE ORIZZONTALI L. DA 1 A 10 SP. 2,5 CM / HORIZONTAL FILLING LATH FROM 1 TO 10 W. 7 TH. 2,5 CM**

Altezza / Height	Finiture / Finishes		
	A	B	C
0 > 240	<b>115</b>	<b>144</b>	<b>173</b>
240,1 > 300	<b>143</b>	<b>179</b>	<b>215</b>

**SUPPLEMENTI / SUPPLEMENTS**

Laccato opaco a campione da aggiungere al prezzo della versione laccato opaco, per ordini inferiori alle 5 elementi  
Custom matt lacquered to be added to the price of the matt lacquered version, for orders lower than 5 elements

**+ 10%**







**STIPITI, MECCANISMI E BINARI  
DOOR JAMB, MECHANISMS AND RAILS**

## STIPITE PER MURATURA O CARTONGESSO BUILT-IN DOOR JAMB FOR WALL OR PLASTER

**Stipite grezzo** da intonacare in estruso di alluminio per muri di spessore minimo 7 cm per porte a tirare o a spingere. (fornito di serie smontato e quindi da montare in opera).

**Unfinished door jamb** in extruded aluminum to be plastered for walls with a minimum thickness of 7 cm for push or pull doors. (supplied to be mounted on site).

### DIMENSIONI STIPITE DOOR JAMB DIMENSIONS

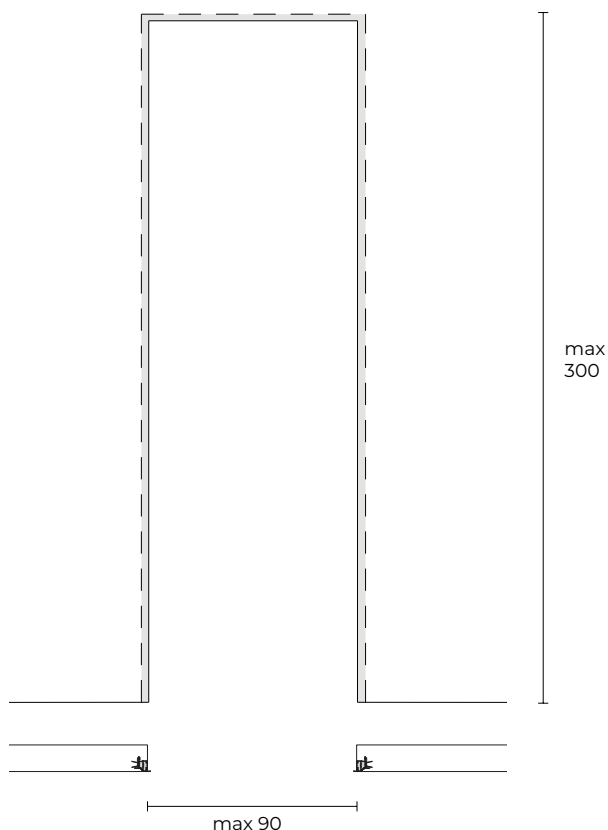

### ABBINAMENTI CON ANTE MATCHING WITH DOORS

#### ABBINAMENTI CON ANTE / MATCHING WITH DOORS

Levia - pag 59

Miss - pag 73

Wave - pag 41

#### STIPITE IMMURATO / BUILT-IN DOOR JAMB

cod. STISTI / STISSP

Larghezza / Width	Altezza / Height	Grezzo / Raw
70 > 90	0 > 210	<b>570</b>
70 > 90	210,1 > 260	<b>600</b>
70 > 90	260,1 > 300	<b>630</b>

**NOTE** Gli stipiti Filo Muro sono forniti grezzi quindi soggetti alle normali imperfezioni dell'alluminio estruso. Si ricorda infatti che lo stipite dopo la sua installazione deve essere intonacato.

**NOTES** Door jambs are unfinished, therefore subjects to the normal imperfections of the extruded aluminium. We remind that the jamb, after the installation, must be painted as the wall.

## STIPITE ARC PER PORTE BATTENTI ARC DOOR JAMB FOR SWING DOORS

**Stipite telescopico** realizzato in estruso di alluminio, dotato di guarnizione di battuta e guarnizione perimetrale interposta tra lo stipite e il muro. La particolare conformazione di questo stipite permette di completarlo con un inserto in varie finiture. Completo di prolunga stipite per diversi spessori del muro.

**Telescopic door jamb** made of extruded aluminium, equipped with a stop gasket and perimeter gasket interposed between the door jamb and the wall. The particular conformation of this door jamb allows it to be completed with an insert in various finishes. Complete with jamb extension for different wall thicknesses.

### DIMENSIONI STIPITE DOOR JAMB DIMENSIONS

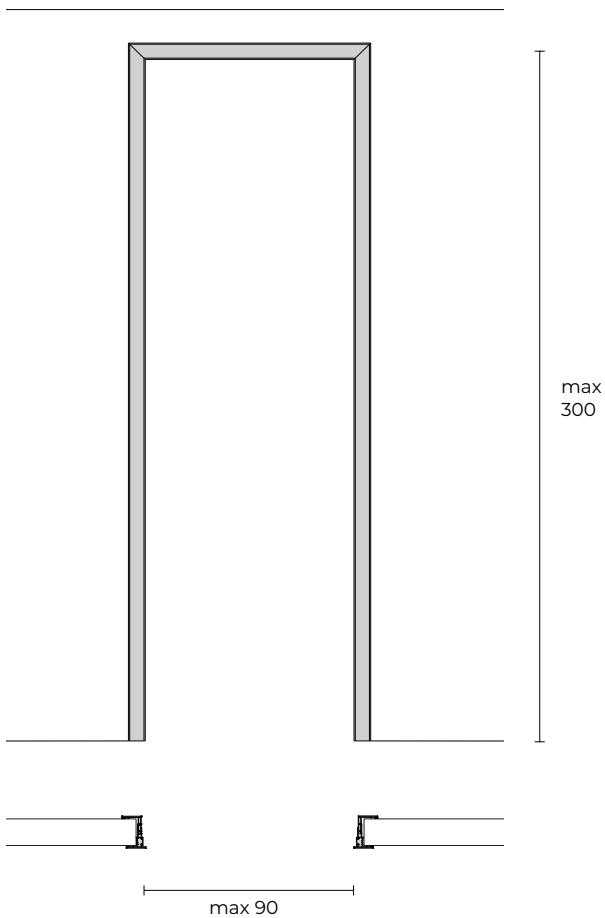

### ABBINAMENTI CON ANTE MATCHING WITH DOORS

#### ABBINAMENTI CON ANTE / MATCHING WITH DOORS

Levia - pag 59

Miss - pag 73

Wave - pag 41

# FINITURE STIPITE ARC DOOR JAMB FINISHES

## VETRI LACCATI / LACQUERED GLASS

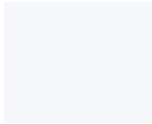

Glass Neve  
Glass Neve Acidato



Glass Corda  
Glass Corda Acidato



Glass Fango  
Glass Fango Acidato



Glass Tabacco  
Glass Tabacco Acidato



Glass Caffè  
Glass Caffè Acidato



Glass Grigio  
Glass Grigio Acidato



Glass Antracite  
Glass Antracite Acidato



Glass Nero  
Glass Nero Acidato

## VETRI LACCATI SPECIALI / SPECIAL LACQUERED GLASS



Glass Bronzo  
Glass Bronzo Acidato



Glass Piombo  
Glass Piombo Acidato



Glass Oro  
Glass Oro Acidato



Glass Argento  
Glass Argento Acidato



Glass Antimonio  
Glass Antimonio Acidato



Glass Platino  
Glass Platino Acidato

## LACCATI OPACHI O LUCIDI / MATT OR GLOSSY LACQUERED \*



Neve



Corda



Fango



Tabacco

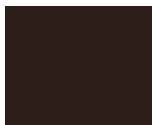

Caffè



Grigio



Antracite

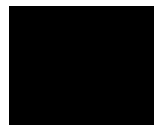

Nero

## LACCATI SPECIALI / SPECIAL LACQUERED



Bronzo



Piombo



Argento



Oro



Antimonio

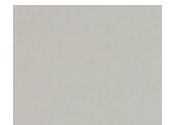

Platino

## METALLI / METALS



Anodizzato Titanio



Anodizzato Bronzo Scuro

## GRES PORCELLANATO / PORCELAIN STONEWARE \*\*



Shard



Diamond

## LEGNI / WOOD



Canaletto



Rovere



Rovere Grigio



Rovere TT

## LEGNI SPECIALI / SPECIAL WOOD \*\*\*



Sand



Lava

I colori sono indicativi / Colors are indicative

\* Laccato Lucido a richiesta / Glossy Lacquered on request

\*\* Grès Porcellanato a richiesta / Porcelain Stoneware on request

\*\*\* Legni a campione previa valutazione / Special wood available upon request

# STIPITE ARC PER PORTE BATTENTI ARC DOOR JAMB FOR SWING DOORS

STIPITE / DOOR JAMB			cod. STIABT		
Larghezza / Width	Altezza / Height	Anodizzato Titanio Anodizzato Bronzo Scuro	Laccato Opaco / Matt Lacquered	Laccato Speciale / Special Lacquered	
70 > 90	0 > 210	<b>820</b>	<b>985</b>	<b>1185</b>	
70 > 90	210,1 > 260	<b>900</b>	<b>1080</b>	<b>1300</b>	
70 > 90	260,1 > 300	<b>960</b>	<b>1155</b>	<b>1390</b>	



## Finiture inserto / Insert finishes

Cat. A - Specchio, Specchio Fumo, Specchio Ambra, Vetri Laccati / Lacquered Glass

Cat. B - Vetri Laccati Acidati, Laccati Opachi, Legni\* / Lacquered Frosted Glass, Matt Lacquered, Wood\*

Cat. C - Specchi Acidati, Laccati Speciali, Legni Speciali\* / Frosted Mirror, Special Lacquered, Special Wood\*

\* Fornito di serie con venatura verticale / Supplied with vertical veining

INSERTO PER STIPITE / INSERT FOR DOOR JAMB			cod. STIABT		
Larghezza / Width	Altezza / Height	Finiture / Finishes			
		A	B	C	
70 > 90	0 > 210	<b>835</b>	<b>1031</b>	<b>1228</b>	
70 > 90	210,1 > 260	<b>922</b>	<b>1151</b>	<b>1381</b>	
70 > 90	260,1 > 300	<b>983</b>	<b>1236</b>	<b>1488</b>	

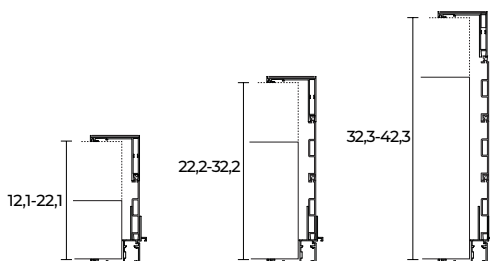

PROLUNGA STIPITE / EXTENSION FOR DOOR JAMB			cod. STIABT		
Larghezza / Width	Altezza / Height	Muro / Wall	Anodizzato Titanio Anodizzato Bronzo Scuro	Laccato Opaco Matt Lacquered	Laccato Speciale Special Lacquered
70 > 90	0 > 210	12,1 > 22,1	<b>285</b>	<b>342</b>	<b>410</b>
70 > 90	0 > 210	22,2 > 32,2	<b>464</b>	<b>557</b>	<b>668</b>
70 > 90	0 > 210	32,3 > 42,3	<b>587</b>	<b>705</b>	<b>846</b>
70 > 90	210,1 > 260	12,1 > 22,1	<b>314</b>	<b>377</b>	<b>453</b>
70 > 90	210,1 > 260	22,2 > 32,2	<b>520</b>	<b>624</b>	<b>749</b>
70 > 90	210,1 > 260	32,3 > 42,3	<b>644</b>	<b>773</b>	<b>928</b>
70 > 90	260,1 > 300	12,1 > 22,1	<b>333</b>	<b>400</b>	<b>480</b>
70 > 90	260,1 > 300	22,2 > 32,2	<b>559</b>	<b>671</b>	<b>805</b>
70 > 90	260,1 > 300	32,3 > 42,3	<b>683</b>	<b>820</b>	<b>984</b>

## SUPPLEMENTI / SUPPLEMENTS

Stipite o prolunga stipite laccati opaco a campione da aggiungere al prezzo della versione laccato opaco, per ordini inferiori alle 5 ante  
Custom matt lacquered door jamb or extension to be added to the price of the matt lacquered version, for orders lower than 5 doors

**+ 10%**

# STIPITE BASIC PER PORTE BATTENTI BASIC DOOR JAMB FOR SWING DOORS

**Stipite telescopico** realizzato in estruso di alluminio, dotato di guarnizione di battuta e guarnizione perimetrale interposta tra lo stipite e il muro. Completo di prolunga stipite per diversi spessori del muro.

**Telescopic door jamb** made of extruded aluminium, equipped with a stop gasket and perimeter gasket interposed between the door jamb and the wall. Complete with door jamb extension for different wall thicknesses.

## DIMENSIONI STIPITE DOOR JAMB DIMENSIONS

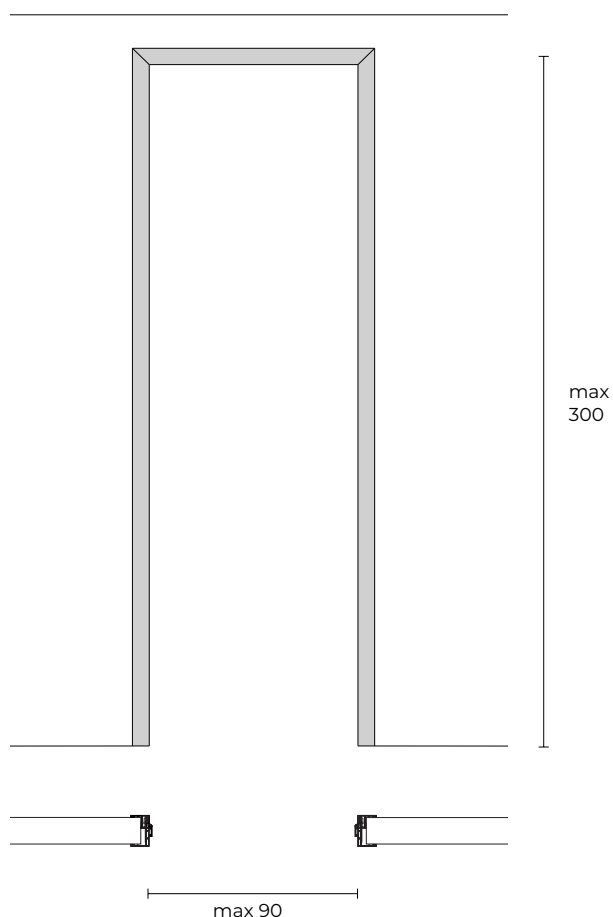

## FINITURE FINISHES

### LACCATI OPACHI O LUCIDI / MATT O GLOSSY LACQUERED \*



### LACCATI SPECIALI / SPECIAL LACQUERED



### METALLI / METALS



## ABBINAMENTI CON ANTE MATCHING WITH DOORS

### ABBINAMENTI CON ANTE / MATCHING WITH DOORS

Levia - pag 59

Miss - pag 73

Wave - pag 41

I colori sono indicativi / Colors are indicative

\* Laccato Lucido a richiesta / Glossy Lacquered on request

# STIPITE BASIC PER PORTE BATTENTI BASIC DOOR JAMB FOR SWING DOORS

STIPITE / DOOR JAMB					cod. STIBBT
Larghezza / Width	Altezza / Height	Anodizzato Titanio Anodizzato Bronzo Scuro	Laccato Opaco Matt Lacquered	Laccato Speciale Special Lacquered	
70 > 90	0 > 210	<b>853</b>	<b>1024</b>	<b>1229</b>	
70 > 90	210,1 > 260	<b>942</b>	<b>1130</b>	<b>1356</b>	
70 > 90	260,1 > 300	<b>1004</b>	<b>1205</b>	<b>1446</b>	

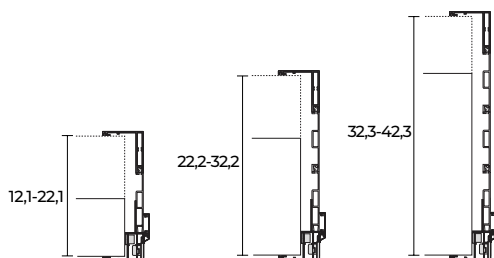

PROLUNGA STIPITE / EXTENSION FOR DOOR JAMB						cod. STIBBT
Larghezza / Width	Altezza / Height	Muro / Wall	Anodizzato Titanio Anodizzato Bronzo Scuro	Laccato Opaco Matt Lacquered	Laccato Speciale Special Lacquered	
70 > 90	0 > 210	12,1 > 22,1	<b>285</b>	<b>342</b>	<b>410</b>	
70 > 90	0 > 210	22,2 > 32,2	<b>464</b>	<b>557</b>	<b>668</b>	
70 > 90	0 > 210	32,3 > 42,3	<b>587</b>	<b>705</b>	<b>846</b>	
70 > 90	210,1 > 260	12,1 > 22,1	<b>314</b>	<b>377</b>	<b>453</b>	
70 > 90	210,1 > 260	22,2 > 32,2	<b>520</b>	<b>624</b>	<b>749</b>	
70 > 90	210,1 > 260	32,3 > 42,3	<b>644</b>	<b>773</b>	<b>928</b>	
70 > 90	260,1 > 300	12,1 > 22,1	<b>333</b>	<b>400</b>	<b>480</b>	
70 > 90	260,1 > 300	22,2 > 32,2	<b>559</b>	<b>671</b>	<b>805</b>	
70 > 90	260,1 > 300	32,3 > 42,3	<b>683</b>	<b>820</b>	<b>984</b>	

## SUPPLEMENTI / SUPPLEMENTS

Stipite o prolunga stipite laccati opaco a campione da aggiungere al prezzo della versione laccato opaco, per ordini inferiori alle 5 ante  
Custom matt lacquered door jamb or extension to be added to the price of the matt lacquered version, for orders lower than 5 doors

**+ 10%**

# STIPITE ARC PER PORTE A SCOMPARSA ARC DOOR JAMB FOR POCKET DOORS

**Stipite telescopico** realizzato in estruso di alluminio, dotato di guarnizione di battuta e guarnizione perimetrale interposta tra lo stipite e il muro. La particolare conformazione di questo stipite permette di completarlo con un inserto in varie finiture.

**Telescopic door jamb** made of extruded aluminium, equipped with a stop gasket and perimeter gasket interposed between the door jamb and the wall. The particular conformation of this door jamb allows it to be completed with an insert in various finishes.

## DIMENSIONI STIPITE DOOR JAMB DIMENSIONS

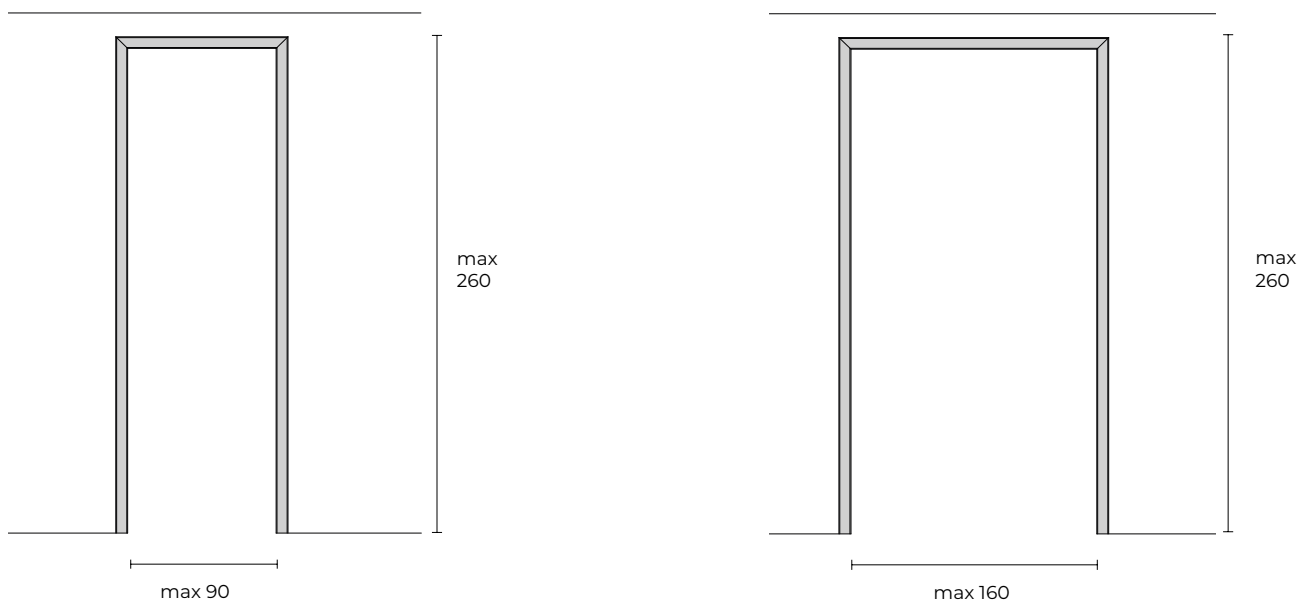

## INFO TECNICHE TECHNICAL INFO

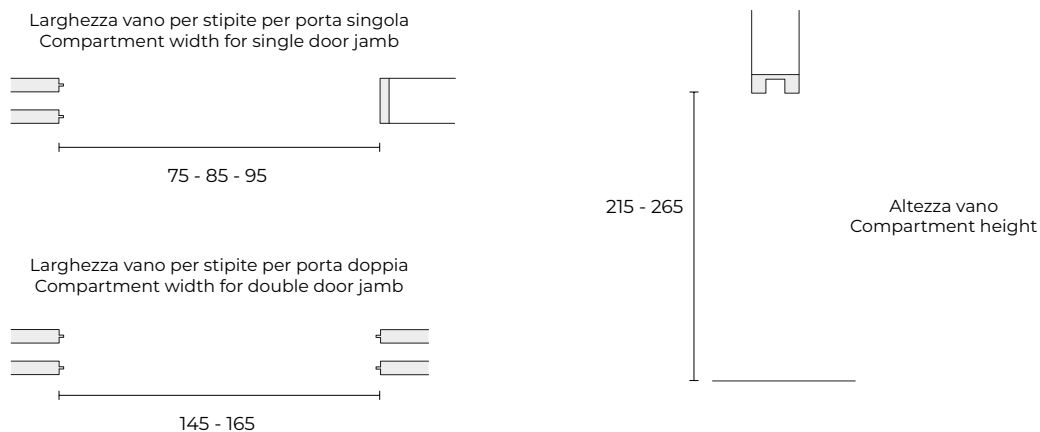

## ABBINAMENTI CON ANTE MATCHING WITH DOORS

### ABBINAMENTI CON ANTE / MATCHING WITH DOORS

Levia - pag 59

Miss - pag 73



VETRI LACCATI / LACQUERED GLASS



Glass Neve  
Glass Neve Acidato

Glass Corda  
Glass Corda Acidato

Glass Fango  
Glass Fango Acidato

Glass Tabacco  
Glass Tabacco Acidato



Glass Caffè  
Glass Caffè Acidato

Glass Grigio  
Glass Grigio Acidato

Glass Antracite  
Glass Antracite Acidato

Glass Nero  
Glass Nero Acidato

VETRI LACCATI SPECIALI / SPECIAL LACQUERED GLASS



Glass Bronzo  
Glass Bronzo Acidato

Glass Piombo  
Glass Piombo Acidato

Glass Oro  
Glass Oro Acidato

Glass Argento  
Glass Argento Acidato

Glass Antimonio  
Glass Antimonio Acidato

Glass Platino  
Glass Platino Acidato

LACCATI OPACHI O LUCIDI / MATT OR GLOSSY LACQUERED \*



Neve

Corda

Fango

Tabacco



Caffè

Grigio

Antracite

Nero

LACCATI SPECIALI / SPECIAL LACQUERED



Bronzo

Piombo

Argento



Oro

Antimonio

Platino

METALLI / METALS



Anodizzato Titanio

Anodizzato Bronzo Scuro

GRES PORCELLANATO / PORCELAIN STONEWARE \*\*



Shard

Diamond

LEGNI / WOOD



Canaletto

Rovere

Rovere Grigio

Rovere TT

LEGNI SPECIALI / SPECIAL WOOD \*\*\*

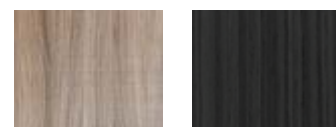

Sand

Lava

I colori sono indicativi / Colors are indicative

\* Laccato Lucido a richiesta / Glossy Lacquered on request

\*\* Grès Porcellanato a richiesta / Porcelain Stoneware on request

\*\*\* Legni a campione previa valutazione / Special wood available upon request

# STIPITE ARC PER PORTE A SCOMPARSA ARC DOOR JAMB FOR POCKET DOORS

STIPITE / DOOR JAMB				cod. STIASC
Larghezza / Width	Altezza / Height	Anodizzato Titanio Anodizzato Bronzo Scuro	Laccato Opaco / Matt Lacquered	Laccato Speciale / Special Lacquered
75-85-95	215	<b>820</b>	<b>985</b>	<b>1185</b>
145-165	215	<b>915</b>	<b>1100</b>	<b>1320</b>
75-85-95	265	<b>900</b>	<b>1080</b>	<b>1300</b>
145-165	265	<b>973</b>	<b>1168</b>	<b>1400</b>



### Finiture inserto / Insert finishes

Cat. A - Specchio, Specchio Fumo, Specchio Ambra, Vetri Laccati / Lacquered Glass

Cat. B - Vetri Laccati Acidati, Laccati Opachi, Legni\* / Lacquered Frosted Glass, Matt Lacquered, Wood\*

Cat. C - Specchi Acidati, Laccati Speciali, Legni Speciali\* / Frosted Mirror, Special Lacquered, Special Wood\*

\* Fornito di serie con venatura verticale / Supplied with vertical veining

INSERTO PER STIPITE / INSERT FOR DOOR JAMB				cod. STIASC
Larghezza / Width	Altezza / Height	Finiture / Finishes		
		A	B	C
75	215	<b>285</b>	<b>338</b>	<b>410</b>
85	215	<b>291</b>	<b>345</b>	<b>420</b>
95	215	<b>297</b>	<b>332</b>	<b>430</b>
145	215	<b>305</b>	<b>360</b>	<b>440</b>
165	215	<b>320</b>	<b>377</b>	<b>460</b>
75	265	<b>339</b>	<b>405</b>	<b>490</b>
85	265	<b>345</b>	<b>412</b>	<b>500</b>
95	265	<b>351</b>	<b>420</b>	<b>510</b>
145	265	<b>360</b>	<b>428</b>	<b>520</b>
165	265	<b>380</b>	<b>445</b>	<b>540</b>

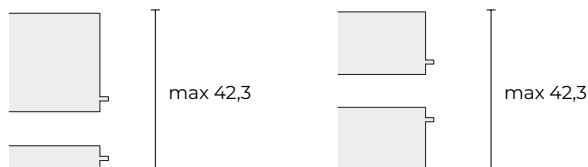

PROLUNGA STIPITE / EXTENSION FOR DOOR JAMB					cod. STIASC
Larghezza / Width	Altezza / Height	Muro / Wall	Anodizzato Titanio Anodizzato Bronzo Scuro	Laccato Opaco Matt Lacquered	Laccato Speciale Special Lacquered
75-85-95	215	12,1 > 22,1	<b>285</b>	<b>342</b>	<b>410</b>
		22,2 > 32,2	<b>464</b>	<b>557</b>	<b>668</b>
		32,3 > 42,3	<b>587</b>	<b>705</b>	<b>846</b>
145-165	215	12,1 > 22,1	<b>314</b>	<b>377</b>	<b>453</b>
		22,2 > 32,2	<b>520</b>	<b>624</b>	<b>749</b>
		32,3 > 42,3	<b>644</b>	<b>773</b>	<b>928</b>
75-85-95	265	12,1 > 22,1	<b>333</b>	<b>400</b>	<b>480</b>
		22,2 > 32,2	<b>559</b>	<b>671</b>	<b>805</b>
		32,3 > 42,3	<b>683</b>	<b>820</b>	<b>984</b>
145-165	265	12,1 > 22,1	<b>873</b>	<b>1050</b>	<b>1170</b>
		22,2 > 32,2	<b>1082</b>	<b>1302</b>	<b>1450</b>
		32,3 > 42,3	<b>1340</b>	<b>1615</b>	<b>1800</b>

### SUPPLEMENTI / SUPPLEMENTS

Stipite o prolunga stipite laccati opaco a campione da aggiungere al prezzo della versione laccato opaco, per ordini inferiori alle 5 ante  
Custom matt lacquered door jamb or extension to be added to the price of the matt lacquered version, for orders lower than 5 doors

**+ 10%**

# STIPITE BASIC PER PORTE A SCOMPARSA BASIC DOOR JAMB FOR POCKET DOORS

Stipite telescopico realizzato in estruso di alluminio, dotato di guarnizione di battuta e guarnizione perimetrale interposta tra lo stipite e il muro.

Telescopic door jamb made of extruded aluminium, equipped with a stop gasket and perimeter gasket interposed between the door jamb and the wall.

## DIMENSIONI STIPITE DOOR JAMB DIMENSIONS

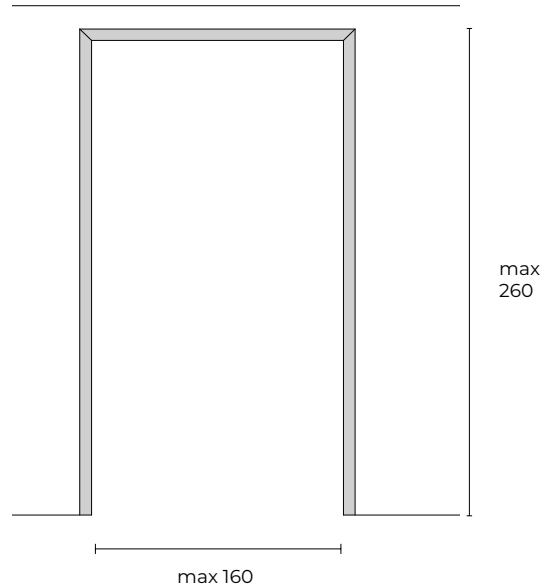
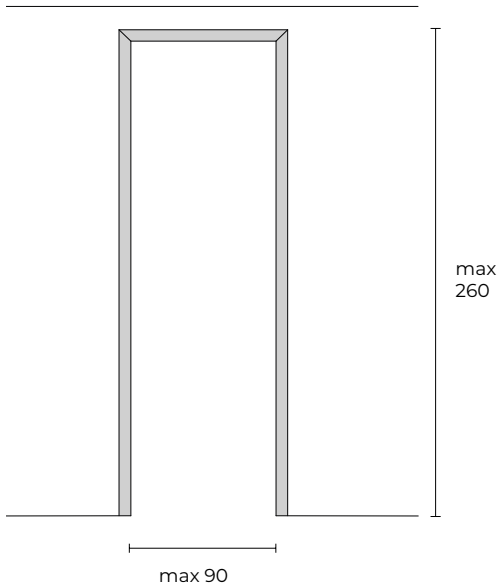

## INFO TECNICHE TECHNICAL INFO

Larghezza vano per stipite per porta singola  
Compartment width for single door jamb

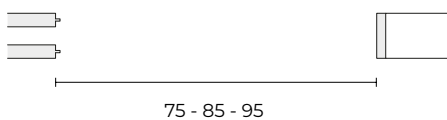

Larghezza vano per stipite per porta doppia  
Compartment width for double door jamb

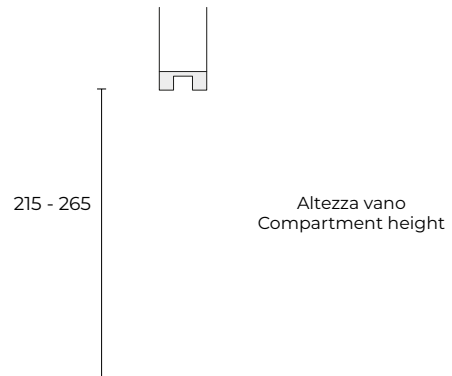
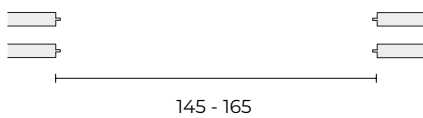

## ABBINAMENTI CON ANTE MATCHING WITH DOORS

### ABBINAMENTI CON ANTE / MATCHING WITH DOORS

Levia - pag 59

Luna - pag 65

I colori sono indicativi / Colors are indicative

\* Laccato Lucido a richiesta / Glossy Lacquered on request

LACCATI OPACHI O LUCIDI / MATT O GLOSSY LACQUERED \*



Neve

Corda

Fango

Tabacco



Caffè

Grigio

Antracite

Nero

LACCATI SPECIALI / SPECIAL LACQUERED



Bronzo

Piombo

Argento



Oro

Grafite

Platino

METALLI / METALS



Anodizzato Titanio

Anodizzato Bronzo Scuro

I colori sono indicativi / Colors are indicative

\* Laccato Lucido a richiesta / Glossy Lacquered on request

# STIPITE BASIC PER PORTE A SCOMPARSA BASIC DOOR JAMB FOR POCKET DOORS

STIPITE / DOOR JAMB		cod. STIBSC		
Larghezza / Width	Altezza / Height	Anodizzato Titanio Anodizzato Bronzo Scuro	Laccato Opaco Matt Lacquered	Laccato Speciale Special Lacquered
75 - 85 - 95	210	<b>853</b>	<b>1024</b>	<b>1229</b>
75 - 85 - 95	260	<b>942</b>	<b>1130</b>	<b>1356</b>
145	210	<b>1327</b>	<b>1593</b>	<b>1912</b>
145	260	<b>1465</b>	<b>1758</b>	<b>2100</b>
165	210	<b>1516</b>	<b>1820</b>	<b>2185</b>
165	260	<b>1673</b>	<b>2009</b>	<b>2400</b>

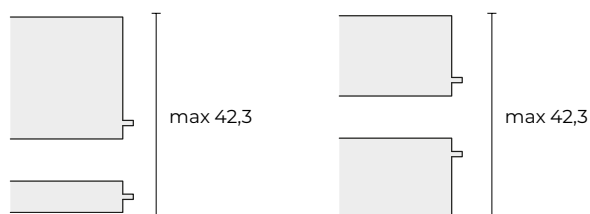

PROLUNGA STIPITE / EXTENSION FOR DOOR JAMB			cod. STIASC		
Larghezza / Width	Altezza / Height	Muro / Wall	Anodizzato Titanio Anodizzato Bronzo Scuro	Laccato Opaco Matt Lacquered	Laccato Speciale Special Lacquered
75-85-95	215	12,1 > 22,1	<b>285</b>	<b>342</b>	<b>410</b>
		22,2 > 32,2	<b>464</b>	<b>557</b>	<b>668</b>
		32,3 > 42,3	<b>587</b>	<b>705</b>	<b>846</b>
145-165	215	12,1 > 22,1	<b>314</b>	<b>377</b>	<b>453</b>
		22,2 > 32,2	<b>520</b>	<b>624</b>	<b>749</b>
		32,3 > 42,3	<b>644</b>	<b>773</b>	<b>928</b>
75-85-95	265	12,1 > 22,1	<b>333</b>	<b>400</b>	<b>480</b>
		22,2 > 32,2	<b>559</b>	<b>671</b>	<b>805</b>
		32,3 > 42,3	<b>683</b>	<b>820</b>	<b>984</b>
145-165	265	12,1 > 22,1	<b>873</b>	<b>1050</b>	<b>1170</b>
		22,2 > 32,2	<b>1082</b>	<b>1302</b>	<b>1450</b>
		32,3 > 42,3	<b>1340</b>	<b>1615</b>	<b>1800</b>

## SUPPLEMENTI / SUPPLEMENTS

Stipite o prolunga stipite laccati opaco a campione da aggiungere al prezzo della versione laccato opaco, per ordini inferiori alle 5 ante  
Custom matt lacquered door jamb or extension to be added to the price of the matt lacquered version, for orders lower than 5 doors

**+ 10%**

## BINARI PER PORTE SCORREVOLI RAILS FOR SLIDING DOORS

### Binario con attacco a parete

Binario con attacco a parete in estruso di alluminio applicato tramite viti con fischer, caratterizzato da un angolare da applicare a parete, e da due estrusi in alluminio telescopici. Regolazione in altezza da 0 a +0.5. Max 2 binari. Completo di meccanismo soft closing (minimo 70 cm) in un solo senso (apertura o chiusura) per porte di larghezza max 100 cm. Per larghezze superiori a 100 cm è possibile inserire il meccanismo in apertura e in chiusura.

### Rail attached to the wall

Rail attached to the wall in extruded of aluminium thanks to fischer screws, made of an angular profile for a wall mounting and of 2 telescopic extrusions of aluminium. Adjustable in height from 0 to + 0,5 cm. Max 2 rails. Soft closing mechanism available in single direction (opening or closing) if the width door is up to cm 100 (min. cm 70) and, upon request, in both directions (opening and closing) if width is more cm 100.

### Binario con attacco a soffitto

Binario con attacco a soffitto in estruso di alluminio composto da due estrusi in alluminio telescopici con possibilità di regolazione in altezza da 0 a +0.5. Completo di meccanismo soft closing (minimo 70 cm) in un solo senso (apertura o chiusura) per porte di larghezza max 100 cm. Per larghezze superiori a 100 cm è possibile inserire il meccanismo in apertura e in chiusura.

### Rail attached to the ceiling

Rail attached to the ceiling in extruded of aluminium made of 2 telescopic extrusions. Adjustable in height from 0 to +0,5 cm. Soft closing mechanism available in single direction (opening or closing) if the width door is up to cm 100 (min. cm 70) and, upon request, in both directions (opening and closing) if width is more cm 100.

### Binario con attacco a soffitto incassato

Binario con attacco a soffitto incassato nel cartongesso composto da due estrusi in alluminio telescopici ai quali viene applicato un doppio angolare in alluminio fissato tramite tiranti al soffitto. Max 3 binari. Completo di meccanismo soft closing (minimo 70 cm) in un solo senso (apertura o chiusura) per porte di larghezza max 100 cm. Per larghezze superiori a 100 cm è possibile inserire il meccanismo in apertura e in chiusura. Se non diversamente specificato verrà fornita la versione con tiranti.

### Rail fitted into the plaster ceiling

Rail fitted into the plaster ceiling made of a 2 telescopic extrusions of aluminium fixed thanks to a double angular in aluminium by means of cables to the ceiling. Max of 3 rails. Soft closing mechanism available in single direction (opening or closing) if the width door is up to cm 100 (min. cm 70) and, upon request, in both directions (opening and closing) if width is more cm 100. If not specified at the order, rail supplied with cables.

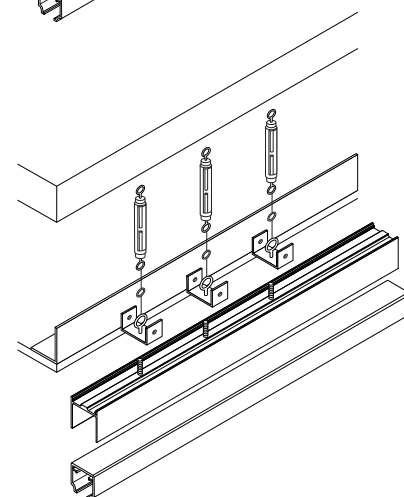
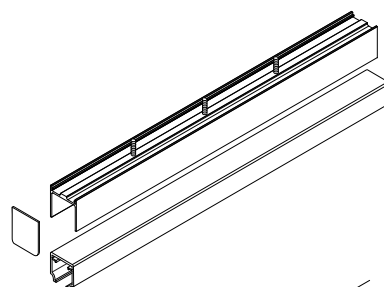
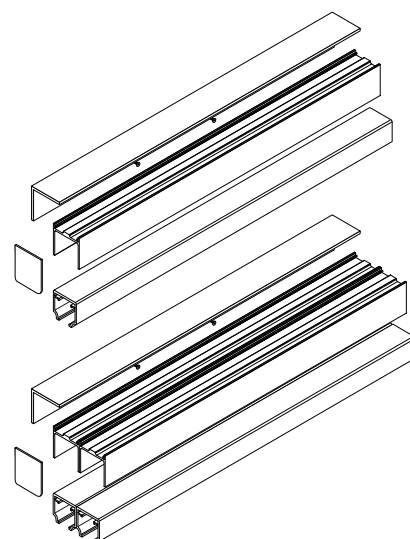

## ABBINAMENTI CON ANTE MATCHING WITH DOORS

### ABBINAMENTI CON ANTE / MATCHING WITH DOORS

Levia - pag 59

Luna - pag 65

Miss - pag 73

D35 - pag 79

LACCATI OPACHI O LUCIDI / MATT O GLOSSY LACQUERED \*

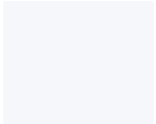

Neve



Corda



Fango



Tabacco



Caffè



Grigio



Antracite



Nero

LACCATI SPECIALI / SPECIAL LACQUERED

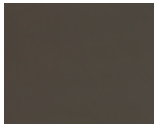

Bronzo



Piombo

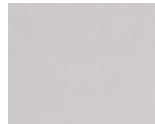

Argento



Oro



Grafite

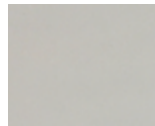

Platino

METALLI / METALS



Anodizzato Titanio



Anodizzato Bronzo Scuro

I colori sono indicativi / Colors are indicative

\* Laccato Lucido a richiesta / Glossy Lacquered on request

# BINARI PER PORTE SCORREVOLI RAILS FOR SLIDING DOORS

## BINARI / RAILS

Larghezza / Width	Anodizzato Titanio - Anodizzato Bronzo Scuro			Laccato RAL 9010 / RAL 9010 Lacquered		
	A parete / To the wall cod. BINP		A soffitto / To the ceiling cod. BINS	Incasso a soffitto / Fitted to the ceiling * cod. BINI		
	Singolo / Single	Doppio / Double		Singolo / Single	Doppio / Double	Triplo / Triple
0 > 200	<b>600</b>	<b>1200</b>	<b>490</b>	<b>720</b>	<b>1440</b>	<b>2160</b>
200,1 > 400	<b>736</b>	<b>1472</b>	<b>605</b>	<b>885</b>	<b>1770</b>	<b>2655</b>
400,1 > 595	<b>868</b>	<b>1736</b>	<b>718</b>	<b>1042</b>	<b>2084</b>	<b>3126</b>

## SUPPLEMENTI / SUPPLEMENTS

Binario laccato con colori Laccati Opachi / Matt Lacquered rail	<b>220</b>
Binario laccato con colori Laccati Speciali / Special Lacquered rail	<b>237</b>
Tappo supplementare per versione a binario libero / Supplementary cap for free track version	<b>255</b>

\* Se non diversamente specificato verrà fornita la versione con tiranti / If not specified at the order, rail supplied with cables.

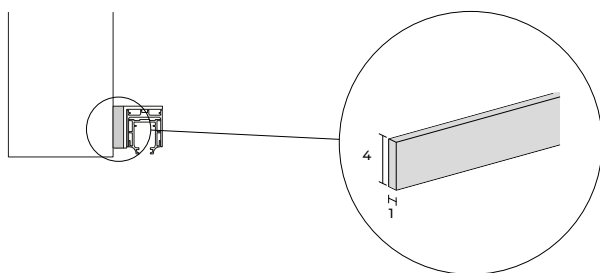

## FASCIA RETROBINARIO PER BINARI A PARETE IN MDF / REAR FILLER FOR RAILS ATTACHED TO THE WALL IN MDF

cod. FASM

Larghezza / Width	In nuance col binario / In nuance with the rail
0 > 200	<b>152</b>
200,1 > 250	<b>170</b>
250,1 > 300	<b>194</b>

**NOTE** In caso di richiesta di consegna anticipata dei binari, questa non prevede l'invio dei relativi carrelli. Se richiedi anticipatamente, questo comporterà un addebito di € 97 per porta che sarà poi detratto dal successivo ordine della relativa porta.

**NOTES** RES will supply rails without their trolley in case of a request for anticipated delivery of the rails. If the Client requires that the trolley is supplied together with the rail then RES will charge 97 € per door (deducted in the future invoice of its door).





Pies

**MANIGLIE  
HANDLES**

# MANIGLIE PER PORTE BATTENTI HANDLES FOR SWING DOORS

\*



## MANIGLIA ML

Finiture / Finishes	€
Cromo satinato / Matt chrome	160
Cromo lucido / Glossy chrome	145
Nichel satinato / Matt nickel	180

\*



## MANIGLIA OL

Finiture / Finishes	€
Cromo satinato / Matt chrome	145
Cromo lucido / Glossy chrome	130
Antracite satinato / Matt Anthracite	180
Bronzo satinato / Mat bronze	185
Oro satinato / Matt gold	165

\*



## MANIGLIA OR

Finiture / Finishes	€
Cromo satinato / Matt chrome	320
Cromo lucido / Glossy chrome	300
Antracite satinato / Matt Anthracite	350
Bronzo satinato / Matt bronze	355

\* A QUESTI ARTICOLI SONO APPLICATE DIVERSE CONDIZIONI DI SCONTO. PREGO CONTROLLARE E TENERNE CONTO.  
\* DIFFERENT DISCOUNT CONDITIONS APPLY TO THESE ITEMS. PLEASE CHECK AND TAKE NOTE OF IT.



**SIDUS**

# INFO TECNICHE SIDUS

## DATA SHEETS

**Montante** di dimensioni 16 x 2,5 h 240/280/320 costituito da un estruso di alluminio, con fissaggio terra-soffitto tramite pistoni regolabili (escursione 3 cm) e piedini in plastica. Le altezze sono personalizzabili tramite tagli a misura. La posizione del montante è a 17 cm dalla parete retrostante. Tale posizione è personalizzabile.

**Ripiano** in particelle di legno rivestito in nobilitato bianco finitura impronta Matrix oppure nobilitato rovere moro di spessore 2,5 cm. La profondità di serie è 50 cm. Le larghezze sono 60-90-105-120 cm personalizzabili tramite taglio su misura. L'aggancio al montante avviene tramite perni eccentrici.

**Upright** made of extruded aluminium whose dimensions are cm 16 x 2,5 x h 240/280/320, with blocking system floor-ceiling thanks to adjustable pistons (3 cm tolerance) and plastic feet. Any height is possible thanks to personalized cutting of the upright. It is placed at 17 cm from the back wall (upon request it can be moved).

**Shelf** in laminated Matrix or brown oak of 2,5 cm thickness. Standard depth is 50 cm. Width: 60-90-105-120 cm and any possible cut on request. It is linked to the upright through eccentric collars.

### DETTAGLI TECNICI

### TECHNICAL DETAILS

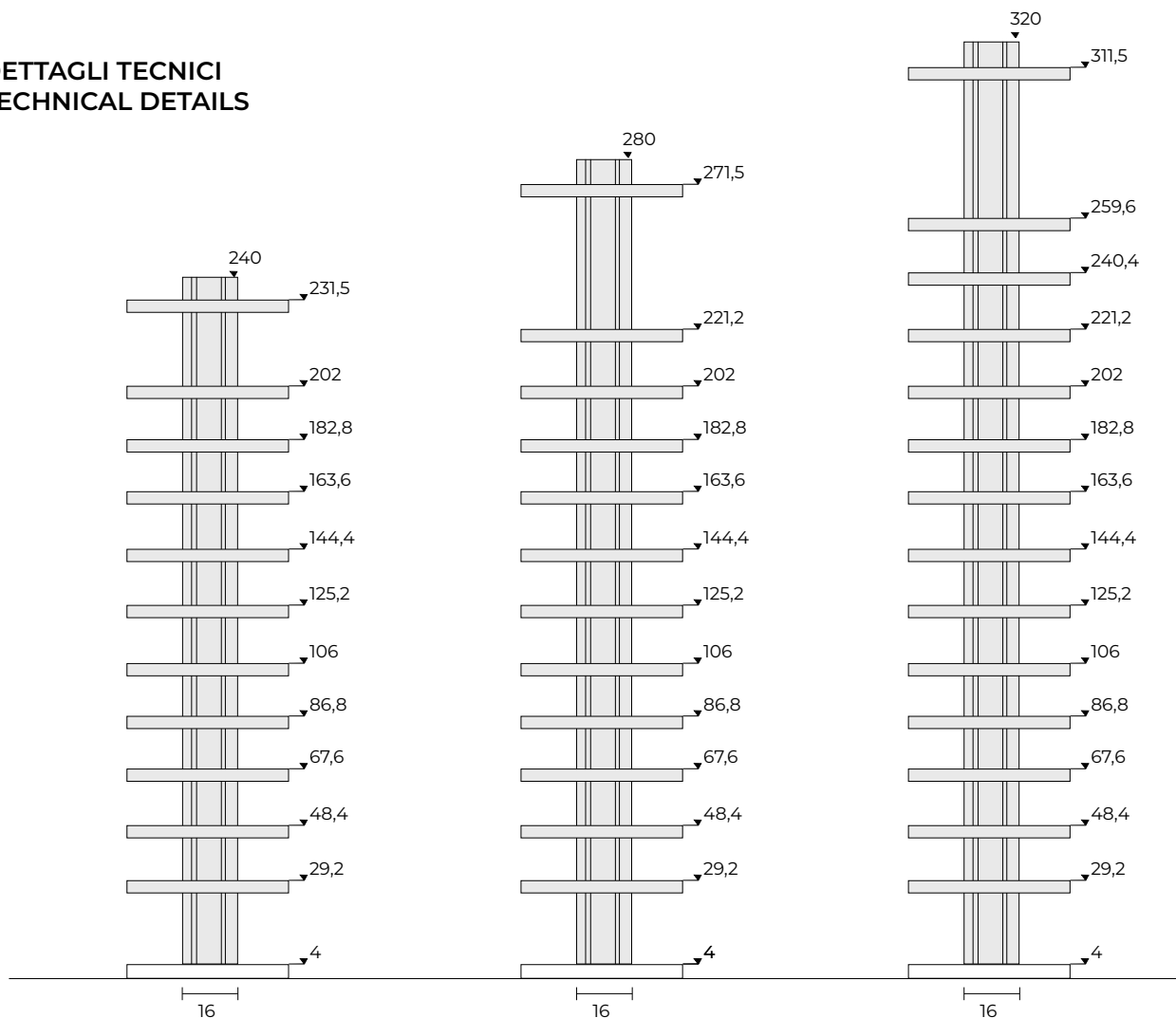

### FINITURE

### FINISHES

#### NOBILITATI / LAMINATED



Matrix



Rovere Moro

#### METALLI / METALS



Titanio

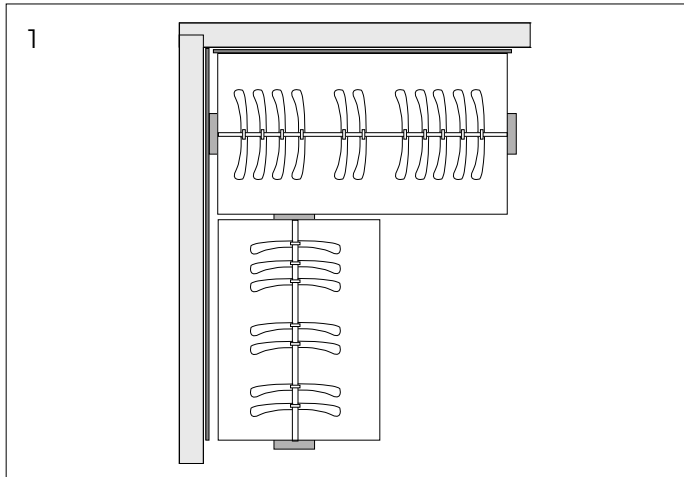

Standard per angolo.  
 Position of the upright in case of a corner.

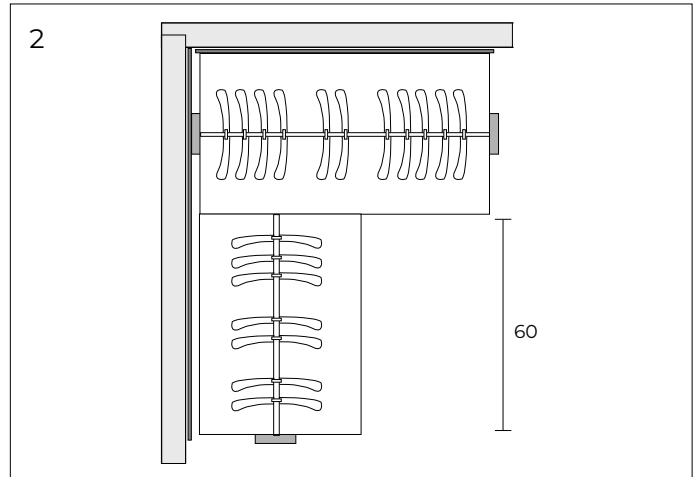

Standard per angolo continuo (senza montante) possibile solo con ripiano laterale da 60 cm, limitato nella portata del peso.  
 Open corner (no upright in between) for 60 cm shelf only. Only for light weight.

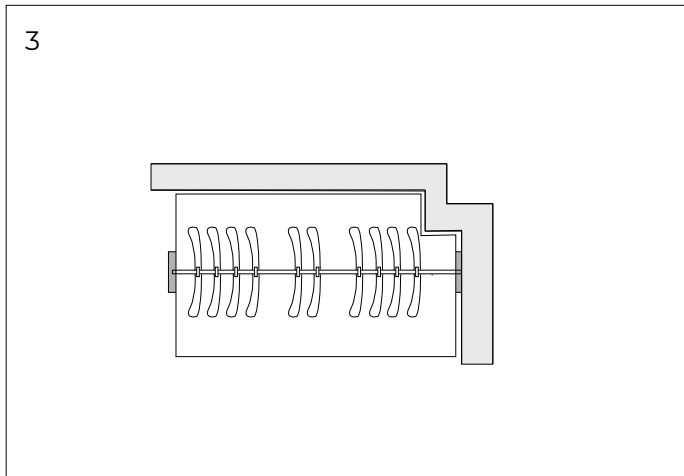

Su richiesta per taglio pilastro.  
 Column on one side.

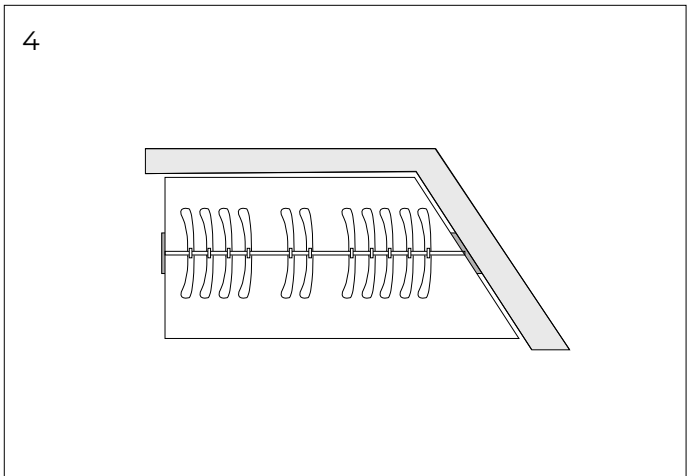

Su richiesta per pareti laterali inclinate.  
 Special shape.

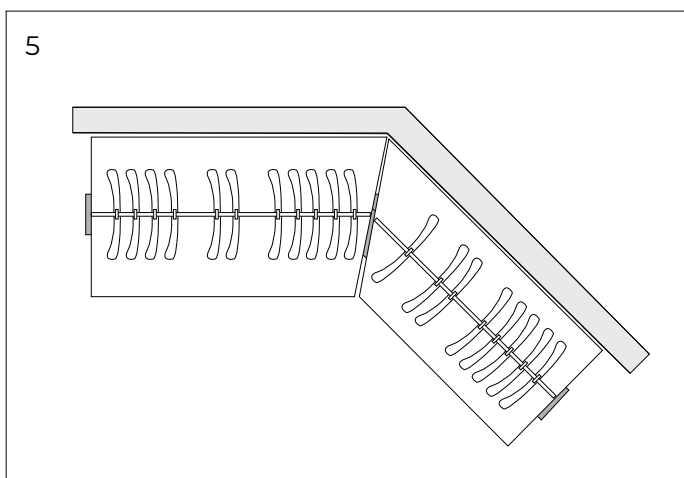

Su richiesta ad angolo per pareti inclinate.  
 Special shape.

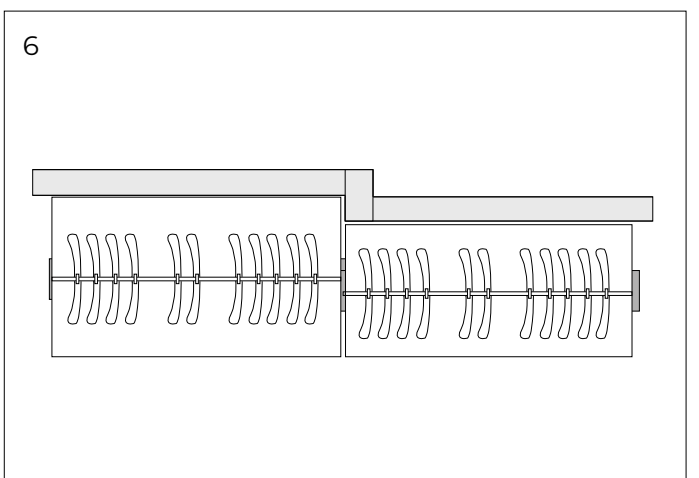

Su richiesta per pareti con cambio di profondità.  
 Change of depth.

SOLUZIONI POSSIBILI E SU RICHIESTA **SIDUS**  
POSSIBLE SOLUTIONS AND MADE TO MEASURE

Uso della squadretta - Use of bracket

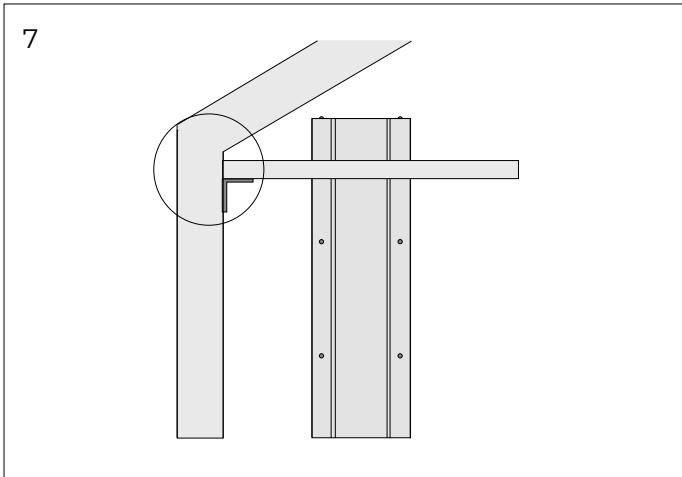

Per soffitti mansardati.  
For inclined roof.

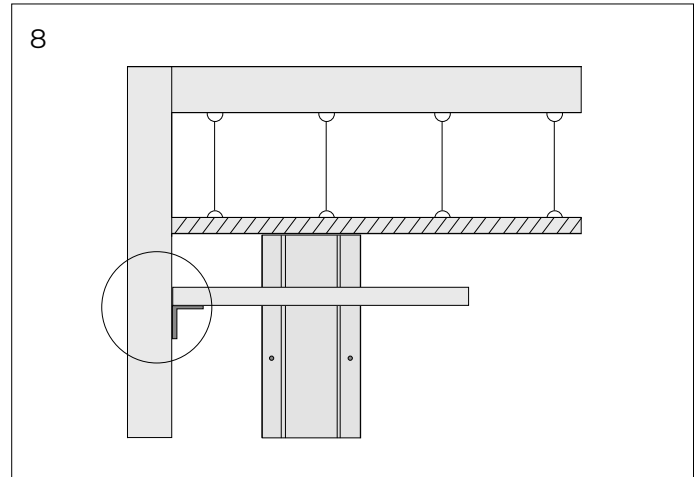

Per controsoffitti o abbassamenti.  
For lowered ceiling.

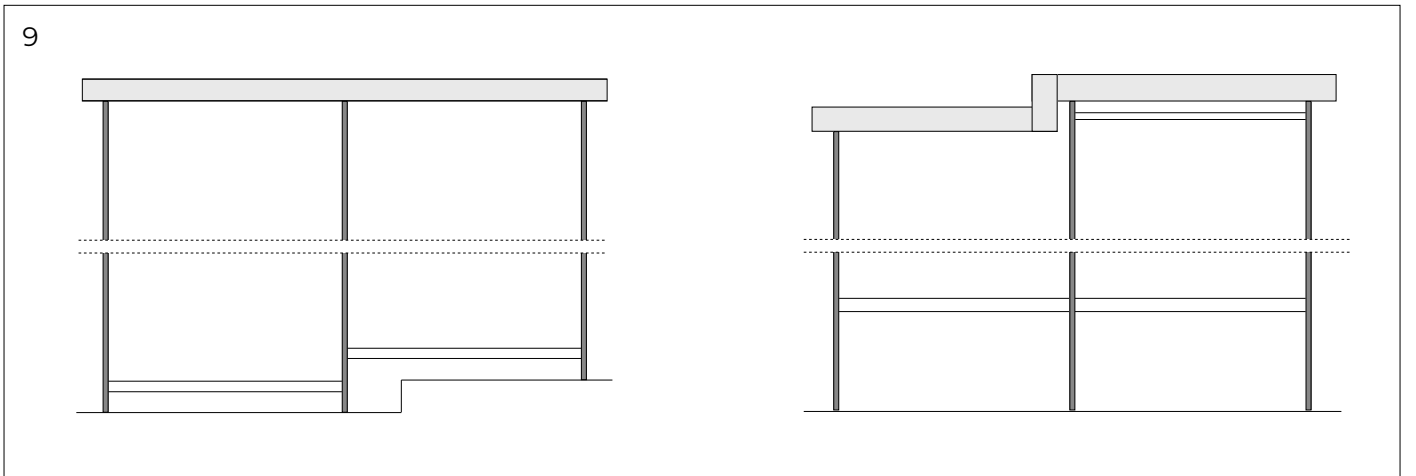

Su richiesta per cambio di livello del pavimento o del soffitto.  
Change of roof/pavement level.

**Montante** di dimensioni 16 x 2,5 h 240/280/320 costituito da un estruso di alluminio con fissaggio terra-soffitto tramite pistoni regolabili (escursione 3 cm) e piedini. Le altezze sono personalizzabili tramite tagli a misura. La posizione del montante è a 17 cm dalla parete retrostante. Tale posizione è personalizzabile.  
Finiture: Titanio

**Upright** made of extruded aluminium whose dimensions are cm 16 x 2,5 x h 240/280/320, with blocking system floor-ceiling thanks to adjustable pistons (3 cm tolerance), feet. Any height is possible thanks to personalized cutting of the upright.  
It is placed at 17 cm from the back wall (upon request it can be moved).  
Finishing: Titanio

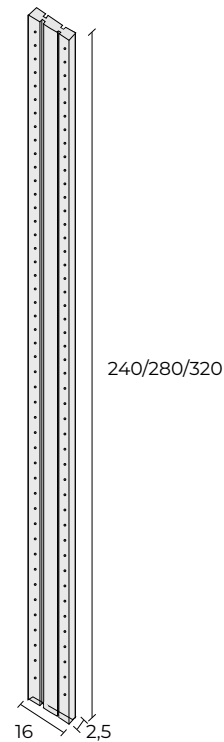

Larghezza / Width	Titanio	
	Codice / Code	€
240 + 3 (di estensione spintore / extension)	<b>MT24</b>	<b>273</b>
280 + 3 (di estensione spintore / extension)	<b>MT28</b>	<b>288</b>
320 + 3 (di estensione spintore / extension)	<b>MT32</b>	<b>318</b>

# MONTANTI SIDUS UPRIGHT

**Squadretta** per il fissaggio a parete del ripiano nel caso in cui il montante non è fissato terra-soffitto.

Si consiglia n. 1 squadretta per ogni elemento.

**Bracket** for fixing the upright to the back wall.  
N. 1 bracket is necessary for every elements.



	CODICE / CODE	€
Squadretta / Bracket	SQ	33

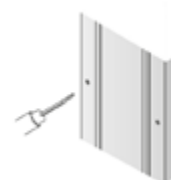

	CODICE / CODE	€
Coppia di fori supplementari / Extra holes 2 per upright	FS	8



## BASI E RIPIANO **SIDUS** BASE AND SHELF

**Base** composta da un ripiano in particelle di legno rivestito in nobilitato bianco finitura impronta Matrix oppure Rovere Moro e da un piedino per uno spessore totale di 3,5 cm. La profondità di serie è di 50 cm. Le larghezze sono 60 - 90 - 105 - 120 cm.

**Base** made up of a shelf in laminated Matrix or Rovere Moro version and a feet for a total of 3,5 cm height. Standard depth is 50 cm. Width: 60 - 90 - 105 and 120 cm.

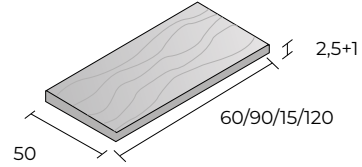

Larghezza / Width	Matrix		Rovere Moro	
	Codice / Code	€	Codice / Code	€
60	BSM60	103	BSR60	103
90	BSM90	129	BSR90	129
105	BSM105	138	BSR105	138
120	BSM120	149	BSR120	148

SUPPLEMENTI / EXTRA CHARGES	CODICE / CODE	€
Taglio in lunghezza / Cut in length	RBL	33
Taglio in profondità / Cut in depth	RBP	48
Taglio inclinato / Inclined cut	RBSI	79

**Ripiano** in particelle di legno rivestito in nobilitato bianco finitura impronta Matrix oppure nobilitato Rovere Moro di spessore 2,5 cm. La profondità di serie è 50 cm. Le larghezze sono 60 - 90 - 105 - 120 cm personalizzabili tramite taglio su misura. L'aggancio al montante avviene tramite perni eccentrici.

**Shelf** in laminated Matrix or Rovere Moro of 2,5 cm thickness. Standard depth is 50 cm. Width: 60 - 90 - 105 - 120 cm and any possible cut on request. It is linked to the upright through eccentric collars.

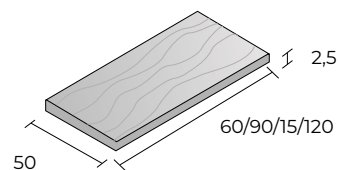

Larghezza / Width	Matrix		Rovere Moro	
	Codice / Code	€	Codice / Code	€
60	BS60M	83	BS60R	83
90	BS90M	99	BS90R	99
105	BS10M	108	BS10R	108
120	BS12M	117	BS12R	117

SUPPLEMENTI / EXTRA CHARGES	CODICE / CODE	€
Taglio in lunghezza / Cut in length	RRL	24
Taglio in profondità / Cut in depth	RRP	36
Taglio inclinato / Inclined cut	RPSI	60

## TOP E TUBO APPENDIABILI SIDUS TOP AND HANGER POLE

**Top** in particelle di legno rivestito in nobilitato bianco finitura impronta Matrix oppure nobilitato Rovere Moro di altezza 9,5 cm. Le larghezze sono 60 - 90 - 105 - 120 cm personalizzabili tramite taglio su misura.

**Top** in laminated Matrix or Rovere Moro of 9,5 cm height. Width: 60 - 90 - 105 - 120 cm and any possible cut on request.

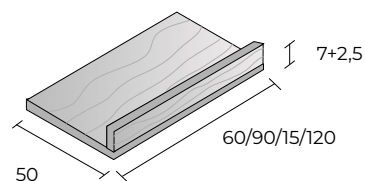

Larghezza / Width	Matrix		Rovere Moro	
	Codice / Code	€	Codice / Code	€
60	TSM60	112	TSR60	112
90	TSM90	134	TSR90	134
105	TSM105	146	TSR105	146
120	TSM120	157	TSR120	157

SUPPLEMENTI / EXTRA CHARGES	CODICE / CODE	€
Taglio in lunghezza / Cut in length	RTSL	33
Taglio in profondità / Cut in depth	RTSP	48
Taglio inclinato / Inclined cut	RTSI	79

**Tubo appendiabiti** realizzato in tubo di acciaio laccato Titanio e sostegni in zama verniciati fissati sotto il ripiano. Le lunghezze sono 60 - 90 - 105 - 120cm personalizzabili tramite taglio su misura.

**Hanger pole** made of an iron tube aluminium lacquered in Titanio and a bar supports in aluminium zamack bronze or white, linked to the shelf. Width: 60 - 90 - 105 - 120 cm and any possible cut on request.

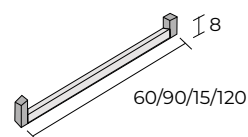

Larghezza / Width	Matrix		Rovere Moro	
	Codice / Code	€	Codice / Code	€
60	TSM60	42	TSR60	42
90	TSM90	46	TSR90	46
105	TSM105	47	TSR105	47
120	TSM120	49	TSR120	49

**Set di 4 ruote** in nylon grigio con supporto in zama verniciato color alluminio e dischetti laterali in ABS color alluminio.

**Set of 4 casters** in grey nylon with support made of zamack painted aluminium colour and side disk in ABS painted aluminium colour.



	CODICE / CODE	€
Set di 4 ruote / Set of 4 casters	R4	87

**N.B.:** In caso di utilizzo di ruote per le cassettiere non ci sarà allineamento coi ripiani / **N.B.:** In case of use of casters for chest of drawers there will be no alignment with the shelves

# CASSETTIERE E BOX SIDUS

## CHEST OF DRAWERS AND BOXES

### IMPORTANTE / IMPORTANT

- \* Possibilità di montaggio sospeso o in appoggio  
With the option to have it hanging or placed on the floor
- \*\* Possibilità di montaggio solo in appoggio  
Placed on the floor only
- \*\*\* Possibilità di montaggio solo sospeso  
Placed hanging only

**Cassettiera a 2-3-4 cassetti** con struttura in nobilitato bianco finitura impronta Matrix oppure nobilitato Rovere Moro. La profondità di serie è 50 cm. Le larghezze sono 60 - 90 cm. I cassetti in nobilitato bianco matrix oppure rovere moro sono alti 19 cm e sono dotati di guide quadro con sistema di chiusura assistita.

**Chest of 2-3-4 drawers** with structure in laminated Matrix or Rovere Moro. Standard depth is 50 cm. Width: 60 - 90 cm. Height of drawers is 19 cm and are supplied of quadro guides with self closing system.

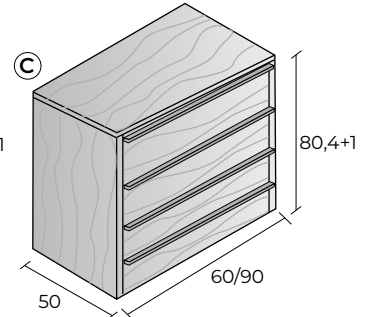
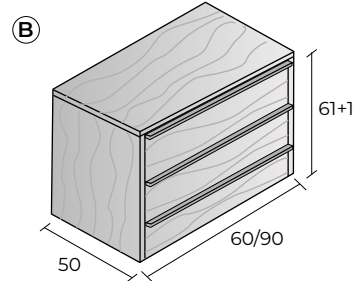
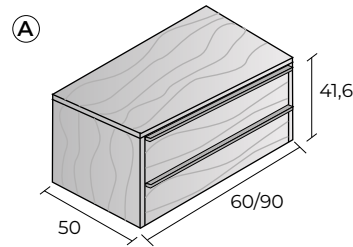

Tipologia / typology	Larghezza / Width	Matrix		Rovere Moro	
		Codice / Code	€	Codice / Code	€
A Cassettiera a 2 cassetti Chest of 2 drawers *	60	AT26B	516	AT26R	516
	90	AT29B	594	AT29R	594
B Cassettiera a 3 cassetti Chest of 3 drawers **	60	AT36B	656	AT36R	656
	90	AT39B	718	AT39R	718
C Cassettiera a 4 cassetti Chest of 4 drawers ***	60	AT46B	813	AT46R	813
	90	AT49B	875	AT49R	875

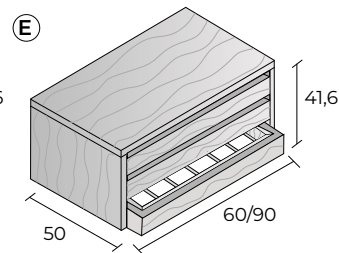
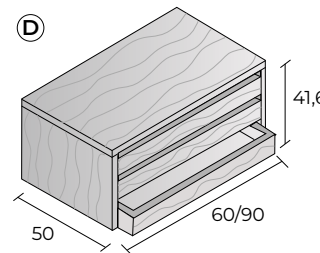
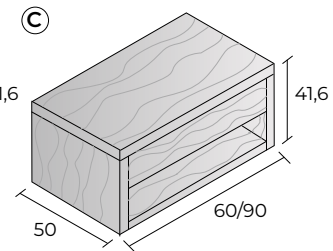
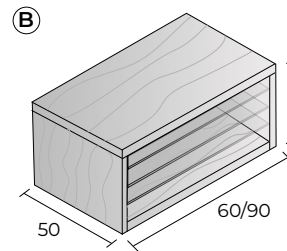
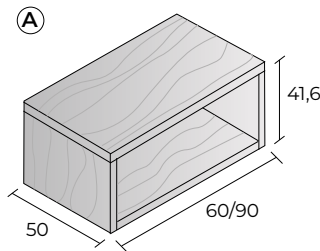

**Box** con struttura in nobilitato bianco finitura impronta Matrix oppure nobilitato Rovere Moro. La profondità di serie è 50 cm. Le larghezze sono 60 - 90 cm.

**Box** with structure in laminated Matrix or Rovere Moro. Standard depth is 50 cm. Width: 60 - 90 cm.

Tipologia / typology	Larghezza / Width	Matrix		Rovere Moro	
		Codice / Code	€	Codice / Code	€
A Box *	60	BA6B	359	BA6R	359
	90	BA9B	388	BA9R	388
B Box con 3 ripiani in vetro Box with 3 glass shelves *	60	BB6B	568	BB6R	568
	90	BB9B	670	BB9R	670
C Box con 1 cassetto Box with 1 drawer *	60	BC6B	471	BC6R	471
	90	BC9B	538	BC9R	538
D Box sospeso con 3 vassoi estraibili Suspended box with 3 pull-out trays *	60	BD6B	674	BD6R	674
	90	BD9B	807	BD9R	807
E Box sospeso con 2 vassoi estraibili e 1 portapantaloni estraibile Suspended box with 2 pull-out trays and 1 pull-out trousers holder ***	60	BE6B	823	BE6R	823
	90	BE9B	927	BE9R	927

# KIT DI ILLUMINAZIONE **SIDUS** LIGHTING SET

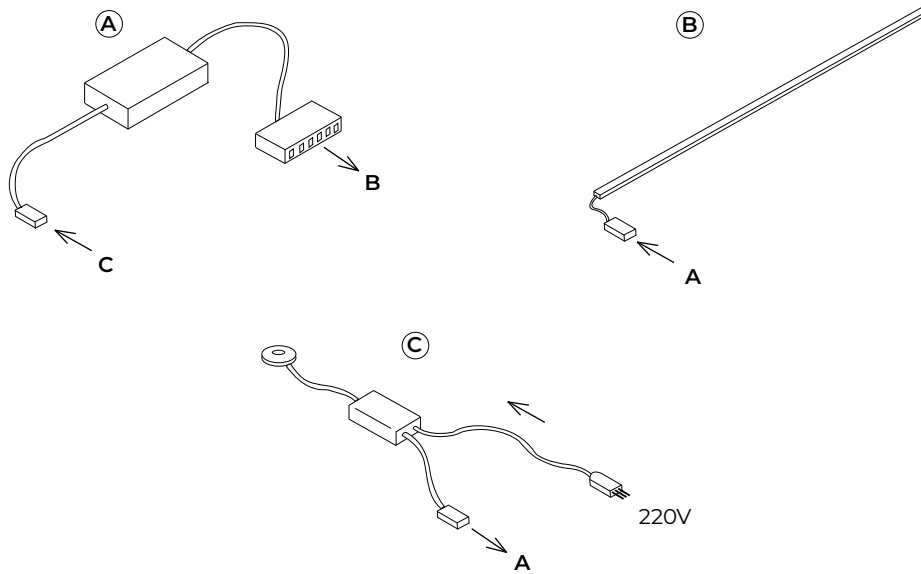

Tipologia / typology	CODICE / CODE	€
(A) Alimentatore 24V / 24V Feeder	AFD	120
(B) Strip Led / Led stripes	FLD	160 €/ml
(C) Sensore / Sensor switch	ISLF	126

Estetica, funzione, tecnologia, qualità e alta flessibilità produttiva sono i valori cardine attorno ai quali Res fonda le proprie radici dal lontano 1962. Un design originale dal linguaggio internazionale, che reinterpreta il passato con una chiave di lettura trasversale, elegante e contemporanea. Capace, grazie al proprio approccio sartoriale, di dare vita a progetti e collezioni emozionali dallo stile unico e distintivo.

Aesthetics, function, technology, quality and high production flexibility are the key values revolving around which Res has its roots since 1962. An original design with an international language that reinvents the past with a transversal, elegant and contemporary interpretation. Able, thanks to its sartorial approach, to give life to emotional projects and collections with a unique and distinctive style.



via Cassina Savina, 49  
20831 Seregno . MB . Italy  
T +39 0362 238620  
info@resitalia.it  
www.resitalia.it

AD . [massimocavana.com](http://massimocavana.com)  
Print . Nordgraf  
R1 . 10-2023 . All rights reserved



